



**INSDINIA** S.L.  
— INSTRUMENTAL QUIRÚGICO —

1-5

**11**

Diagnostik  
Diagnostic  
Diagnostic  
Diagnostico



28-32

**18**

Neuro chirurgie  
Neuro Surgery  
Neuro chirurgie  
Neuro cirugia



6-14

**12**

Pinzetten  
Forceps  
Pincas  
Pinzas



33

**19**

Nagel instrumente  
Nail Instruments  
Instruments pour ongles  
Instrumentos para unas



15

**13**

Splitterzangen  
Splinter Forceps  
Pincas a echardes  
Pinzas para espinas



34-41

**20**

Scheren,  
Scissors  
Ciseaux  
Tijeras



16-24

**14**

Verschiedene Klemmen  
Miscellaneous Forceps  
Pincas diverses  
Pinzas diversas



42-43

**21**

Bandage and Plaster  
Instruments  
Instrumentos para  
vendajes y yeso



25

**15**

Dermatologie  
Dermatology  
Dermatologie  
Dermatologia



44-51

**22**

Instruments with  
Tungsten Carbide Insert  
Instrumentos con  
placas carbuto tungsteno



26

**16**

Messer, Skalpelle  
Knives, Scalpels  
Couteaux, Bistouris  
Cuchillos, Bisturries



52-54

**23**

Naht  
Suture  
Suture  
Sutura



27

**17**

Rektum Instrumente  
Rectal Instruments  
Instruments Rectaux  
Instrumentos Rectales



55

**24**

Impfen und Punktion  
Vaccination, Puncture  
Vaccination et ponction  
Vacunacion y puncion



56

25

Sonden, Watteträger  
Probes, Applicators  
Sondes, Porte-contons  
Sondas, Porta-algodones



98-100

32

Galle, Niere, Urologie  
Bile, Kidney, Urology  
Bile, Rein, Urologie  
Vesicula biliar, Riñón,



57-65

26

Wundhaken  
Retractors  
Ecarteurs  
Separadores



101-110

33

Gynakologie, Geburtshilfe  
Gynecology, Obstetrics  
Gyneologie, Accouchement  
Ginecologia, Obstetricia



66-86

27

Knochen chirurgie  
Bone Surgery  
Chirurgie Osseuse  
Cirugia osea



111-117

34

HNO-Instrumente  
ENT Instruments  
Instruments ORL  
Instrumental ORL



87-90

28

Cardiovascular and  
Thoracic Surgery  
Cirugia cardiocascular  
y Toracoplastica



118-131

35

Augen instrumente  
Ophthalmic Instruments  
Instruments ophtalmologique  
Instrumental oftalmológico

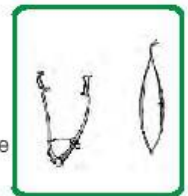

91-92

29

Tracheotomie  
Tracheotomy  
Tracheotomie  
Traqueotomia

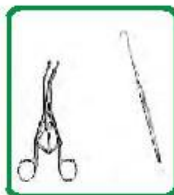

132-135

88

Verschiedene Behälter  
Different Containers  
Boîtes diverses  
Contenedores varios



93-96

30

Narkose  
Anaesthesia  
Anesthesie  
Anestesia



97

31

Magen und Darm  
Stomach, Intestine  
Estomac, Intestin  
Estomago, Intestino



**Diagnostik**  
**Diagnostic**  
**Diagnostic**  
**Diagnóstico**

Kehlkopfspiegel  
Larngal mirrors  
Miroirs laryngiens  
Espejos laríngeos



11.8	Fig. 000	=	6 mmØ	11.28
11.9	Fig. 00	=	8 mmØ	11.29
11.10	Fig. 0	=	10 mmØ	11.30
11.11	Fig. 1	=	12 mmØ	11.31
11.12	Fig. 2	=	14 mmØ	11.32
11.13	Fig. 3	=	16 mmØ	11.33
11.14	Fig. 4	=	18 mmØ	11.34
11.15	Fig. 5	=	20 mmØ	11.35
11.16	Fig. 6	=	22 mmØ	11.36
11.17	Fig. 7	=	24 mmØ	11.37
11.18	Fig. 8	=	26 mmØ	11.38
11.19	Fig. 9	=	28 mmØ	11.39
11.20	Fig. 10	=	30 mmØ	11.40

11.25  
10,0 cm/4"  
Metallgriff für Kehlkopfspiegel  
Metal handle for laryngeal mirrors  
Manche pour miroirs laryngiens  
Mango metálico para espejos laríngeos

Percussions h mmer  
Percussion hammers  
Marteaux-percuteurs  
Martillos de percusi3n



**Babinsky**

22 cm/8¾"

11.45

**Taylor**

20 cm/8"

11.46

**Berliner**

20 cm/8"

11.47

**Traube**

17 cm/6¾"

11.48

**Troemner**

24 cm/9½"

11.49

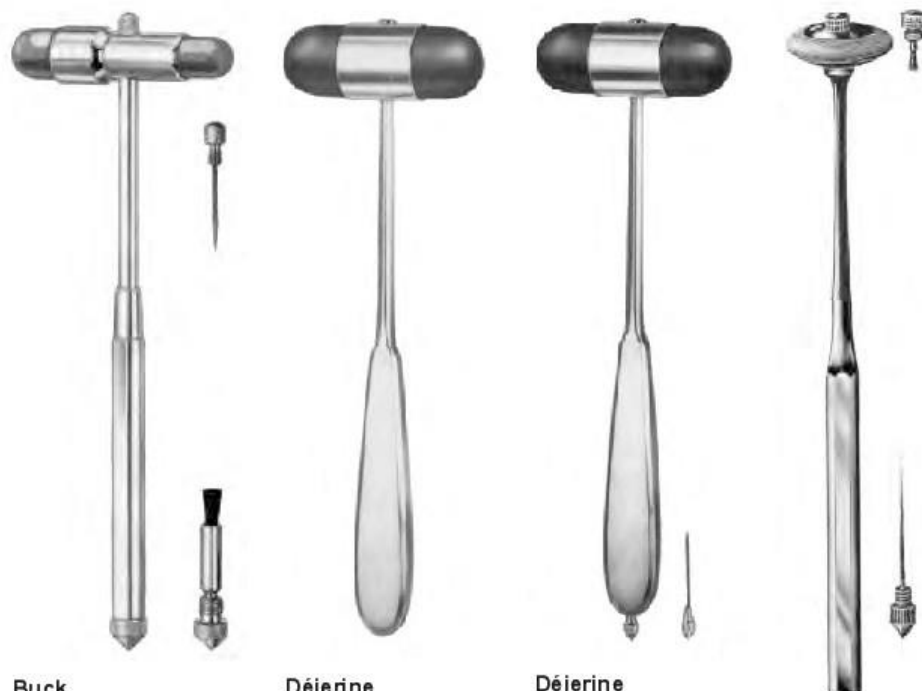

**Buck**

18 cm/7"

11.50

**D jerine**

sin aguja

20 cm/8"

11.51

**D jerine**

con aguja

21 cm/8¼"

11.52

**Rabiner**

11.53

23 cm/9"

**Prüf- und mebinstrumente**  
**Examination and measuring instruments**  
**Instruments pour examiner et mesurer**  
**Instrumento para exámenes y medidas**

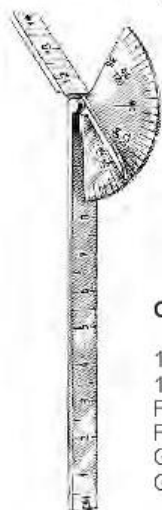

**Caroll**

11.56  
14,0 cm/5½"  
Finger-Goniometer  
Finger-Goniometer  
Goniomètre  
Goniómetro

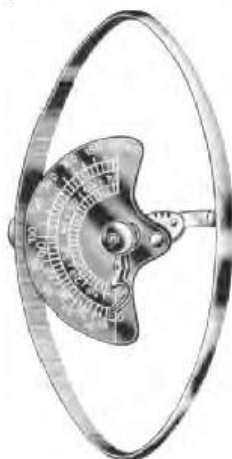

**Collin**

11.57  
12,5 cm/5"  
Dynamometer, für Kinder  
Dynamometer, for children  
Dynamomètre, pour enfants  
Dinamómetro, para niños

11.58  
12,5 cm/5"  
Dynamometer, für Erwachsene  
Dynamometer, for adults  
Dynamomètre, pour adultes  
Dinamómetro, para adultos



**Moeltgen**

11.59  
24,0 cm/9½"  
Winkelmesser für die Gliedmaßen  
Goniometer (Flexometer) for extremities  
Goniomètre pour les membres  
Goniómetro para miembros



**Wartenberg**

11.60  
19,0 cm/7½"  
Nervrädchen  
Neurological Pinwheel  
Roue neurologique  
Instrumento para examen neurológico



11.61  
14,0 cm/5½"  
Taschen-Meßschieber  
aus nichtrostendem Stahl  
Pocket Slide Caliper, of stainless steel  
Pied à coulisse de poche, en acier inoxydable  
Pie de rey de bolsillo, de acero inoxidable

Stimmgabeln  
Tuning forks  
Diapasons  
Diapasónes



**Hartmann**  
c 128  
11.180-00



**Hartmann**  
c<sup>1</sup> 256  
11.180-01



**Hartmann**  
c<sup>2</sup> 512  
11.180-02



**Hartmann**  
c<sup>3</sup> 1024  
11.180-03



**Hartmann**  
c<sup>4</sup> 2048  
11.180-04



**Hartmann**  
c<sup>5</sup> 4096  
11.180-05



**Hartmann**  
c 64  
11.180-06



**Hartmann**  
c 128  
11.180-07



**Hartmann**  
c<sup>1</sup> 256  
11.180-08



**Hartmann**  
mit Fuß, with foot  
avec pied, con pie  
c<sup>1</sup> 256  
11.180-09

Stimmgabeln  
Tuning forks  
Diapasóns  
Diapasónes



**Lucae**  
c 128  
11.181-00

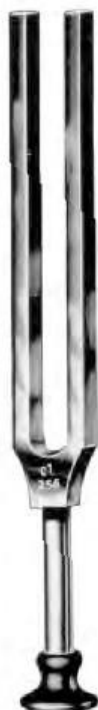

**Lucae**  
c<sup>1</sup> 256  
11.181-01



**Lucae**  
c<sup>2</sup> 512  
11.181-02



**Lucae**  
c<sup>3</sup> 1024  
11.181-03



**Lucae**  
c<sup>4</sup> 2048  
11.181-04



**Lucae**  
c<sup>5</sup> 4096  
11.181-05



**Lucae**  
c 128  
11.181-06

**Pinzetten**  
**Forceps**  
**Pinces**  
**Pinzas**



**Standard**

12.199	10,5cm
12.200	11,5cm
12.201	13,0cm
12.202	14,5cm
12.203	16,0cm
12.204	18,0cm
12.205	20,0cm
12.206	25,0cm
12.207	30,0cm



**Standard**  
gebogen, curved  
courbe, curvas

12.209	10,5cm
12.210	11,5cm
12.211	13,0cm
12.212	14,5cm
12.213	16,0cm
12.214	18,0cm
12.215	20,0cm
12.216	25,0cm
12.217	30,0cm

**Anatomische pinzetten**  
**Dressing forceps**  
**Pinces a dissection**  
**Pinzas de disección**



schmal, narrow  
étroite, estrechas

12.220	11,5cm
12.221	13,0cm
12.222	14,5cm
12.223	16,0cm
12.224	18,0cm
12.225	20,0cm
12.226	25,0cm
12.227	30,0cm



schmal, narrow  
étroite, estrechas

12.230	11,5cm
12.231	13,0cm
12.232	14,5cm
12.233	16,0cm
12.234	18,0cm
12.235	20,0cm
12.236	25,0cm
12.237	30,0cm



fein, delicate  
fine, finas

12.241	13,0cm
12.242	14,5cm



**Schwedisches Modell**  
**Swedish pattern**  
**Modèle suédois**  
**Modelo sueco**

12.247	13,0cm
12.248	15,0cm
12.249	17,0cm



**USA-Mod. Standard**

12.250	12,0cm
12.251	13,0cm
12.252	14,5cm
12.253	15,5cm
12.254	18,0cm
12.255	21,0cm
12.256	25,0cm
12.257	31,0cm



**USA-Mod.**  
schmal, narrow  
étroite, estrechas

12.260	12,0cm
12.261	13,0cm
12.262	14,5cm
12.263	15,5cm



**engl. Mod.**

12.265	13,0cm
12.266	14,5cm
12.267	15,5cm

Anatomische pinzetten  
Dressing forceps  
Pincas a dissection  
Pinzas de disección



**Semken**

12.271 12,5cm  
12.272 15,0cm



**Adson**  
Micro 0,8 mm  
12.274 12,0cm  
1,2 mm  
12.275 12,0cm



**Mc Indoe**

12.277 15,0cm



**Potts-Smith**

12.280 18,0cm  
12.281 21,0cm  
12.282 25,5cm



**Potts-Smith**  
gebogen, curved  
courbe, curvas

12.283 18,0cm  
12.284 21,0cm  
12.285 25,5cm



**Gerald**

12.288 18,0cm



**Gerald**  
gebogen, curved  
courbe, curvas

12.289 18,0cm



**Taylor**

12.290 17,5cm



**Taylor**  
gebogen, curved  
courbe, curvas

12.291 17,5cm



**Taylor**

12.292 17,5cm



**Taylor**  
gebogen, curved  
courbe, curvas

12.293 17,5cm

Anatomische pinzetter  
Dressing forceps  
Pincas a dissection  
Pinzas de disección



**Waugh**  
12.294 15,0cm  
12.295 20,0cm



**Brophy**  
12.296 20,0cm



**Brophy**  
gebogen, curved  
courbe, curvas  
12.297 20,0cm



**Cushing**  
12.298 20,0cm













**Cushing**  
gebogen, curved,  
courbe, curvas  
12.299 20,0cm

Chirurgische pinzetten

Tissue forceps

Pincas a dissection a griffes

Pinzas de disección con dientes

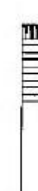
 <p><b>1:2</b></p> <table border="0"> <tr><td>12.300</td><td>10,5cm</td></tr> <tr><td>12.301</td><td>11,5cm</td></tr> <tr><td>12.302</td><td>13,0cm</td></tr> <tr><td>12.303</td><td>14,5cm</td></tr> <tr><td>12.304</td><td>16,0cm</td></tr> <tr><td>12.305</td><td>18,0cm</td></tr> <tr><td>12.306</td><td>20,0cm</td></tr> <tr><td>12.307</td><td>25,0cm</td></tr> <tr><td>12.308</td><td>30,0cm</td></tr> </table>	12.300	10,5cm	12.301	11,5cm	12.302	13,0cm	12.303	14,5cm	12.304	16,0cm	12.305	18,0cm	12.306	20,0cm	12.307	25,0cm	12.308	30,0cm	 <p><b>2:3</b></p> <table border="0"> <tr><td>12.310</td><td>11,5cm</td></tr> <tr><td>12.311</td><td>13,0cm</td></tr> <tr><td>12.312</td><td>14,5cm</td></tr> <tr><td>12.313</td><td>16,0cm</td></tr> <tr><td>12.314</td><td>18,0cm</td></tr> <tr><td>12.315</td><td>20,0cm</td></tr> <tr><td>12.316</td><td>25,0cm</td></tr> <tr><td>12.317</td><td>30,0cm</td></tr> </table>	12.310	11,5cm	12.311	13,0cm	12.312	14,5cm	12.313	16,0cm	12.314	18,0cm	12.315	20,0cm	12.316	25,0cm	12.317	30,0cm	 <p><b>3:4</b></p> <table border="0"> <tr><td>12.321</td><td>13,0cm</td></tr> <tr><td>12.322</td><td>14,5cm</td></tr> <tr><td>12.323</td><td>16,0cm</td></tr> </table>	12.321	13,0cm	12.322	14,5cm	12.323	16,0cm	 <p><b>4:5</b></p> <table border="0"> <tr><td>12.327</td><td>13,0cm</td></tr> <tr><td>12.328</td><td>14,5cm</td></tr> <tr><td>12.329</td><td>16,0cm</td></tr> </table>	12.327	13,0cm	12.328	14,5cm	12.329	16,0cm
12.300	10,5cm																																																
12.301	11,5cm																																																
12.302	13,0cm																																																
12.303	14,5cm																																																
12.304	16,0cm																																																
12.305	18,0cm																																																
12.306	20,0cm																																																
12.307	25,0cm																																																
12.308	30,0cm																																																
12.310	11,5cm																																																
12.311	13,0cm																																																
12.312	14,5cm																																																
12.313	16,0cm																																																
12.314	18,0cm																																																
12.315	20,0cm																																																
12.316	25,0cm																																																
12.317	30,0cm																																																
12.321	13,0cm																																																
12.322	14,5cm																																																
12.323	16,0cm																																																
12.327	13,0cm																																																
12.328	14,5cm																																																
12.329	16,0cm																																																
 <p><b>1:2</b> schmal, narrow étroite, estrechas</p> <table border="0"> <tr><td>12.331</td><td>13,0cm</td></tr> <tr><td>12.332</td><td>14,5cm</td></tr> <tr><td>12.333</td><td>16,0cm</td></tr> <tr><td>12.334</td><td>20,0cm</td></tr> </table>	12.331	13,0cm	12.332	14,5cm	12.333	16,0cm	12.334	20,0cm	 <p><b>USA-Mod. 1:2</b></p> <table border="0"> <tr><td>12.340</td><td>12,0cm</td></tr> <tr><td>12.340</td><td>13,0cm</td></tr> <tr><td>12.342</td><td>14,5cm</td></tr> <tr><td>12.343</td><td>15,5cm</td></tr> <tr><td>12.344</td><td>18,0cm</td></tr> <tr><td>12.345</td><td>21,0cm</td></tr> <tr><td>12.346</td><td>25,0cm</td></tr> <tr><td>12.347</td><td>31,0cm</td></tr> </table>	12.340	12,0cm	12.340	13,0cm	12.342	14,5cm	12.343	15,5cm	12.344	18,0cm	12.345	21,0cm	12.346	25,0cm	12.347	31,0cm	 <p><b>USA-Mod. 2:3</b></p> <table border="0"> <tr><td>12.350</td><td>12,0cm</td></tr> <tr><td>12.351</td><td>13,0cm</td></tr> <tr><td>12.352</td><td>14,5cm</td></tr> <tr><td>12.353</td><td>15,5cm</td></tr> <tr><td>12.354</td><td>18,0cm</td></tr> <tr><td>12.355</td><td>21,0cm</td></tr> <tr><td>12.356</td><td>25,0cm</td></tr> <tr><td>12.357</td><td>31,0cm</td></tr> </table>	12.350	12,0cm	12.351	13,0cm	12.352	14,5cm	12.353	15,5cm	12.354	18,0cm	12.355	21,0cm	12.356	25,0cm	12.357	31,0cm							
12.331	13,0cm																																																
12.332	14,5cm																																																
12.333	16,0cm																																																
12.334	20,0cm																																																
12.340	12,0cm																																																
12.340	13,0cm																																																
12.342	14,5cm																																																
12.343	15,5cm																																																
12.344	18,0cm																																																
12.345	21,0cm																																																
12.346	25,0cm																																																
12.347	31,0cm																																																
12.350	12,0cm																																																
12.351	13,0cm																																																
12.352	14,5cm																																																
12.353	15,5cm																																																
12.354	18,0cm																																																
12.355	21,0cm																																																
12.356	25,0cm																																																
12.357	31,0cm																																																
 <p><b>USA-Mod.</b> fein, delicate fine, finas</p> <table border="0"> <tr><td>12.371</td><td>13,0cm</td></tr> <tr><td>12.372</td><td>14,5cm</td></tr> <tr><td>12.373</td><td>15,5cm</td></tr> </table>	12.371	13,0cm	12.372	14,5cm	12.373	15,5cm	 <p><b>Adlerkreutz</b></p> <table border="0"> <tr><td>15 cm/8"</td><td></td></tr> <tr><td>20 cm/8"</td><td></td></tr> <tr><td>25 cm/10"</td><td></td></tr> </table> <table border="0"> <tr><td>12.374-15</td><td>12.375-15</td></tr> <tr><td>12.374-20</td><td>12.375-20</td></tr> <tr><td>12.374-25</td><td>12.375-25</td></tr> </table>	15 cm/8"		20 cm/8"		25 cm/10"		12.374-15	12.375-15	12.374-20	12.375-20	12.374-25	12.375-25	 <p><b>2:3</b></p>	 <p><b>4:5</b></p>																												
12.371	13,0cm																																																
12.372	14,5cm																																																
12.373	15,5cm																																																
15 cm/8"																																																	
20 cm/8"																																																	
25 cm/10"																																																	
12.374-15	12.375-15																																																
12.374-20	12.375-20																																																
12.374-25	12.375-25																																																

Chirurgische pinzetten  
Tissue forceps  
Pincas a dissection a griffes  
Pinzas de disección con dientes

es



**Semken**

12.381 12,5cm  
12.382 15,0cm

es



**Adson  
Micro 0,8 mm**

12.384 12,0cm  
12.384-15 15,0cm

**1,2 mm**

12.385 12,0cm  
12.385-15 15,0cm



**Adson Brown  
9 x 9**

12.386  
12,0cm

es



**Gillies**

12.387  
15,0cm



**Gerald**

12.388  
17,5cm



**Gerald  
gebogen, curved  
courbe, curvas**

12.389  
17,5cm

es



**Taylor**

12.390 17,5cm

es



**Taylor  
gebogen, curved,  
courbe, curvas**

12.391 17,5cm

es



**Cushing**

12.392 17,5cm

es



**Cushing  
gebogen, curved,  
courbe, curvas**

12.393 17,5cm



**Brophy**

12.394 20,0cm



**Brophy**  
gebogen, curved,  
courbe, curvas

12.395 20,0cm



Chirurgische pinzetten  
Tissue forceps  
Pincas a dissection a griffes  
Pinzas de disección con dientes

**Waugh**

12.396 15,0cm  
12.397 20,0cm



**Taylor**

12.398 17,5cm



**Taylor**

12.399 17,5cm



**Potts-Smith**

12.400 18,0cm  
12.401 21,0cm  
12.402 25,0cm



**Potts-Smith**  
gebogen, curved,  
courbe, curvas

12.403 18,0cm  
12.404 21,0cm  
12.405 25,0cm



**Lane 1:2**

12.407 14,5cm  
12.408 18,0cm



**Lane 2:3**

12.409 14,5cm  
12.410 18,0cm



**Bonney 1:2**

12.411  
18,0cm



**Bonney 2:3**

12.412  
18,0cm

Atrauma-pinzetten  
Atrauma forceps  
Pincés atraumáticos  
Pinzas atáumaticas



**De Bakey**  
gerade, straight,  
droite, rectas

	1,5 mm	2,0 mm	2,7 mm	3,5 mm
16,0 cm/6¼"	12.420-16	12.421-16	12.422-16	12.423-16
20,0 cm/8"	12.420-20	12.421-20	12.422-20	12.423-20
24,0 cm/9½"	12.420-24	12.421-24	12.422-24	12.423-24
30,0 cm/12"	12.420-30	12.421-30	12.422-30	12.423-30



**De Bakey**  
abgewinkelt, angular,  
angulaire, angulares

	2,0 mm
16,0 cm/6¼"	12.424-16
20,0 cm/8"	12.424-20
24,0 cm/9½"	12.424-24
30,0 cm/12"	12.424-30

Splintter pinzetten  
Splinter forceps  
Pincas a echardes  
Pinzas para espinas



**Feilchenfeld**  
12.471 7,5cm  
12.472 9,0cm  
12.473 11,5cm



**Hunter**  
12.474 10,5cm



**Hunter**  
12.475 10,5cm



**Walter-Carmalt**  
12.476 10,5cm



**Walter-Carmalt**  
12.477 10,5cm

Mikroskopierpinzetten  
Microscope Forceps  
Pincas pour microscopier  
Pinzas para el microscopio



12.485  
10,0 cm/4"  
stumpf  
blunt  
mousse  
romas



12.486  
10,0 cm/4"  
spitz  
sharp  
pointue  
agudas

Cillien pinzetten  
Cillia forceps  
Pincas a epiler les cils  
Pinzas depilatorias



**Beer**

12.491 8,0cm  
12.492 9,0cm



**Littauer**

12.493 8,5cm



**Douglas**

schmal, narrow,  
étroite, estrechas

12.494-01 9,0cm



**Douglas**

breit, broad,  
large, anchas

12.494-02 9,0cm

# Splitterzangen Splinter Forceps Pinces à échardes Pinzas para espinas

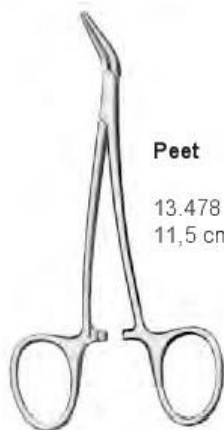

**Peet**  
13.478  
11,5 cm/4½"

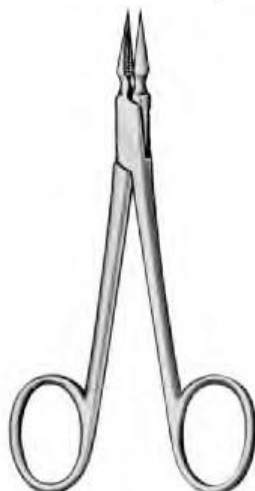

**Arthur**  
13.479  
13,5 cm/5½"  
gerade, straight,  
droite, recta  
13.480  
gebogen, curved,  
courbe, curva



**Stieglitz**  
13.481  
13,5 cm/5½"  
gerade, straight,  
droite, recta  
13.482  
gebogen, curved,  
courbe, curva



**Ralk**  
15,0 cm/6"



13.483  
gerade  
straight  
droite  
recta



13.484  
gebogen  
curved  
courbe  
curva

**Verschiedene Klemmen**  
**Miscellaneous Forceps**  
**Pinces diverses**  
**Pinzas diversas**

Bulldog klemmen  
Bulldog clamps  
Clamps bulldog  
Clamps bulldog

Arterien klemmen  
Hemostatic forceps  
Pinces hemostatiques  
Pinzas hemostáticas



**Dieffenbach**  
6,0 cm/2½"

14.497

14.498

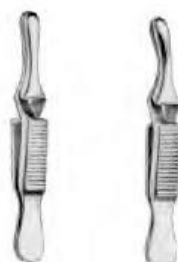

**Dieffenbach**

3,5 cm/1½"  
14.499 13.501

5,0 cm/2"  
14.500 13.502



**John Hopkins**

14.505 5,0 cm/2"  
14506 6,5 cm/2½"  
14.507 7,5 cm/3"



**Hartmann**  
10,0 cm/4"

14.503 micro  
14.508

14.504 micro  
14.509

Arterien klemmen  
Hemostatic forceps  
Pincers hemostatiques  
Pinzas hemostáticas



**Halsted-Mosquito**

- |              |             |              |
|--------------|-------------|--------------|
| 14.510       | 12,5 cm/5"  | 14.515       |
| 14.511       | 14,0 cm/5½" | 14.516       |
| 14.514 micro | 12,5 cm/5"  | 14.519 micro |
| gerade       |             | gebogen      |
| straight     |             | curved       |
| droite       |             | courbe       |
| recta        |             | curva        |



**Halsted-Mosquito 1:2**

- |              |             |              |
|--------------|-------------|--------------|
| 14.520       | 12,5 cm/5"  | 14.525       |
| 14.521       | 14,0 cm/5½" | 14.526       |
| 14.529 micro | 12,5 cm/5"  | 14.530 micro |
| gerade       |             | gebogen      |
| straight     |             | curved       |
| droite       |             | courbe       |
| recta        |             | curva        |

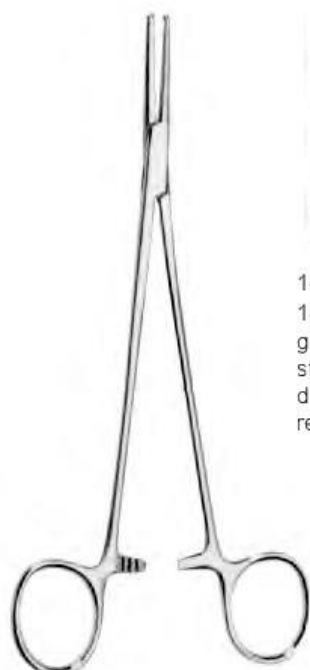

- |          |             |
|----------|-------------|
| 14.512   | 18,0 cm/7"  |
| 14.513   | 21,0 cm/8¼" |
| gerade   |             |
| straight |             |
| droite   |             |
| recta    |             |



- |         |
|---------|
| 14.517  |
| 14.518  |
| gebogen |
| curved  |
| courbe  |
| curva   |

**Halsted-Mosquito**



- |          |             |
|----------|-------------|
| 14.522   | 18,0 cm/7"  |
| 14.523   | 21,0 cm/8¼" |
| gerade   |             |
| straight |             |
| droite   |             |
| recta    |             |



- |         |
|---------|
| 14.527  |
| 14.528  |
| gebogen |
| curved  |
| courbe  |
| curva   |

**Halsted-Mosquito 1:2**

Arterien klemmen  
Hemostatic forceps  
Pincas hemostatiques  
Pinzas hemostáticas



**Pean**  
14.531 14,0 cm/5½"  
14.532 16,0 cm/6¼"



**Pean**  
14,0 cm/5½"  
fein, delicate, fine, fina  
  
14.538  
gerade, straight,  
droite, recta  
  
14.540  
gebogen, curved,  
courbe, curva



**Rochester-Pean**  
gerade, straight,  
droite, recta  
14.533 13,0 cm/5"  
14.541 14,0 cm/5½"  
14.542 16,0 cm/6¼"  
14.543 18,0 cm/7"  
14.544 20,0 cm/8"  
14.545 22,0 cm/8¾"  
14.546 24,0 cm/9½"  
14.547 26,0 cm/10¼"  
14.549 30,0 cm/12"



**Rochester-Pean**  
gebogen, curved,  
courbe, curva  
14.535 13,0 cm/5"  
14.551 14,0 cm/5½"  
14.552 16,0 cm/6¼"  
14.553 18,0 cm/7"  
14.554 20,0 cm/8"  
14.555 22,0 cm/8¾"  
14.556 24,0 cm/9½"  
14.557 26,0 cm/10¼"  
14.559 30,0 cm/12"

Arterien klemmen  
Hemostatic forceps  
Pinces hemostatiques  
Pinzas hemostáticas



**Kocher**  
14,0 cm/5½"  
fein, delicate, fine, fina

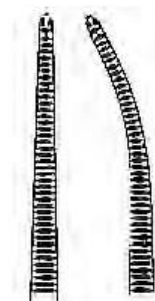

14.566  
gerade  
straight  
droite  
recta

14.568  
gebogen  
curved  
courbe  
curva



**Ochsner-Kocher**  
gerade, straight,  
droite, recta  
14.561 13,0 cm/5"  
14.571 14,0 cm/5½"  
14.572 16,0 cm/6¼"  
14.573 18,0 cm/7"  
14.574 20,0 cm/8"  
14.575 22,0 cm/8¾"  
14.576 24,0 cm/9½"  
14.577 26,0 cm/10¼"  
14.579 30,0 cm/12"



**Ochsner-Kocher**  
gebogen, curved,  
courbe, curva  
14.563 13,0 cm/5"  
14.581 14,0 cm/5½"  
14.582 16,0 cm/6¼"  
14.583 18,0 cm/7"  
14.584 20,0 cm/8"  
14.585 22,0 cm/8¾"  
14.586 24,0 cm/9½"  
14.587 26,0 cm/10¼"  
14.589 30,0 cm/12"

Arterien klemmen  
Hemostatic forceps  
Pincès hemostatiques  
Pinzas hemostáticas

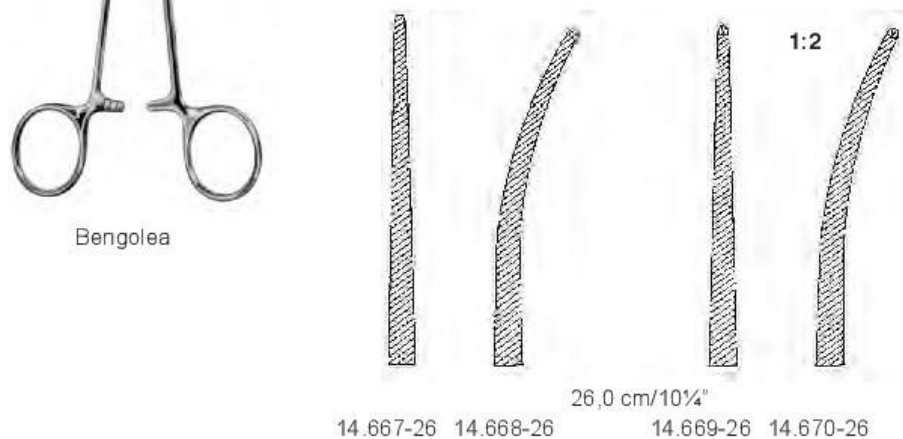
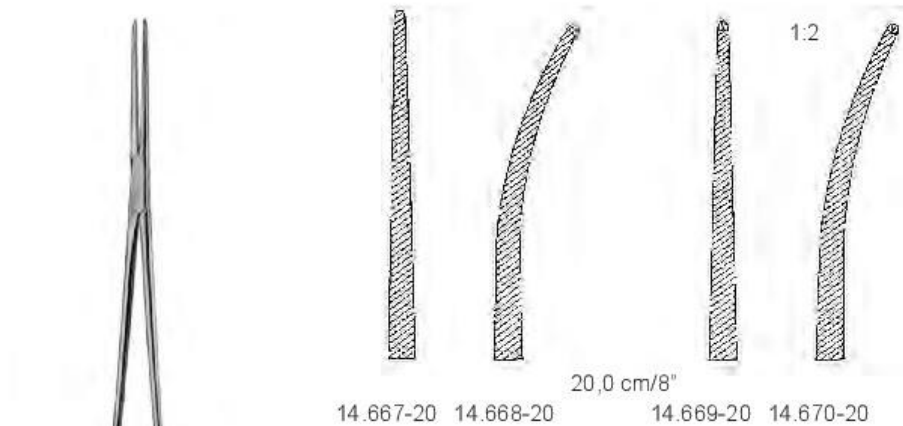
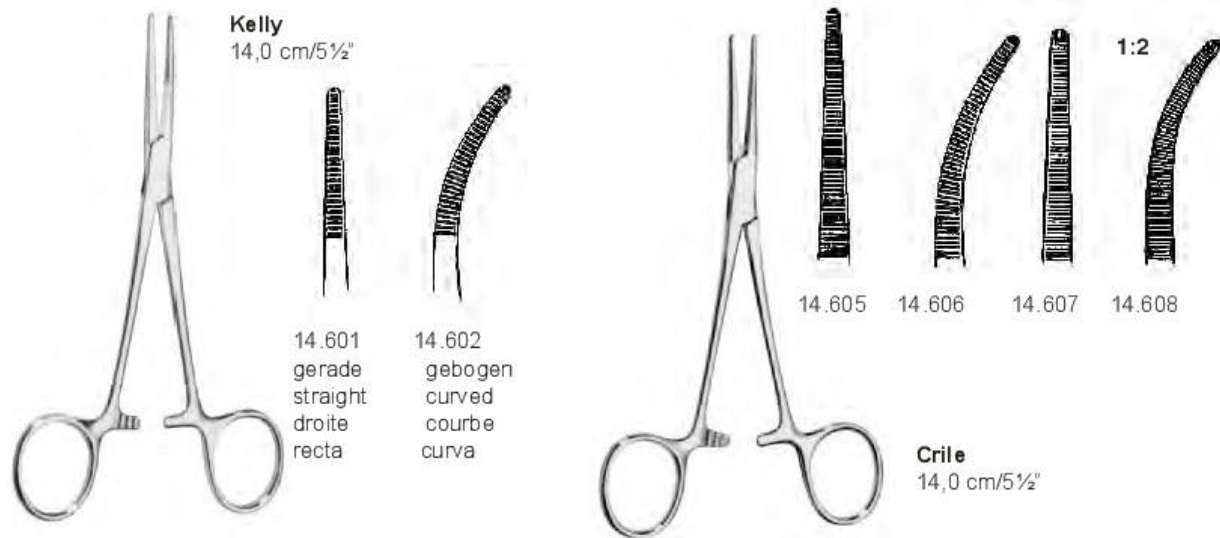

Bengolea

Arterien klemmen  
Hemostatic forceps  
Pinces hemostatiques  
Pinzas hemostáticas



Mini-Gemini

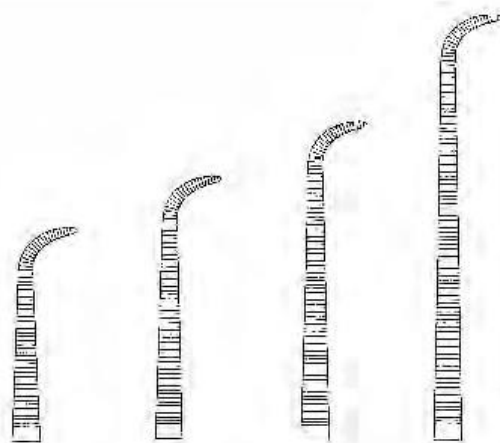

18,0 cm/7"	22,0 cm/8¾"	25,0 cm/10"	28,0 cm/11"
14.671-18	14.671-22	14.671-25	14.671-28



Gemini

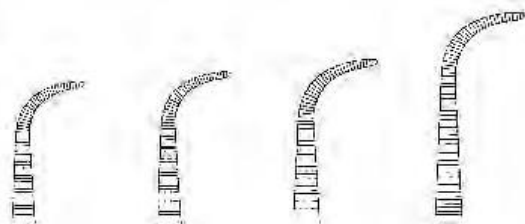

13,0 cm/5"	14,0 cm/5½"	16,0 cm/6¼"	18,0 cm/7"
14.672-13	14.672-14	14.672-16	14.672-18

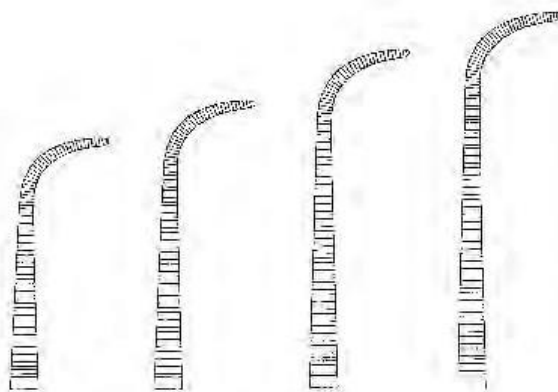

20,0 cm/8"	23,0 cm/9"	25,0 cm/10"	28,0 cm/11"
14.672-20	14.672-23	14.672-25	14.672-28

Arterien klemmen  
Hemostatic forceps  
Pinces hemostatiques  
Pinzas hemostáticas



**Mixer-Baby**  
14.675 14,0 cm/5½"  
14.675-18 18,0 cm/7"



**Mixer**  
14.676 15,5 cm/6"  
14.677 19,0 cm/7½"



13.678  
22,0 cm/8¾"



**Mixer-O'Shaughnessy**  
14.679 15,5 cm/6"  
14.680 19,0 cm/7½"



**Negus**  
19,0 cm/7½"

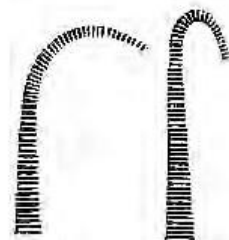

14.681

14.682

Klemmzangen  
Clamp Forceps  
Pincés clamps  
Pinzas clamps

Hysterektomiekiemen  
Hysterectomy Forceps  
Pincés á hysleretomie  
Pinzas para Histerectomia

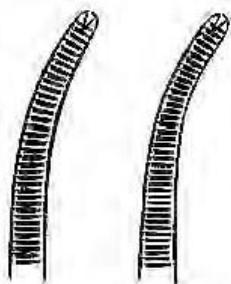

Klemmzangen  
Clamp Forceps  
Pincés clamps  
Pinzas-clamps

**Wertheim**  
22,0 cm/8¾" 23,0 cm/9"  
14.734 14.735

Peritoneumklemmen, Peritoneal Clamp Forceps, Pincés pour péritoine, Pinzas para peritoneo



14.737 14.738

**Mikulicz**  
20,0 cm/8"

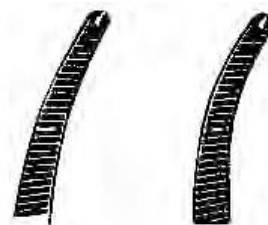

14.739 14.740

**Faure**  
20,0 cm/8"

Tucklemmen  
Towel Forceps  
Pinces à champs  
Pinzas de campo



**Schädel**  
9,0 cm/3½"

14.761  
gebogen  
curved  
courbe  
curva



**Jones**  
14.762 5,5 cm/2¼"  
14.763 9,0 cm/3½"



**Doyen**  
18,0 cm/7"  
14.764

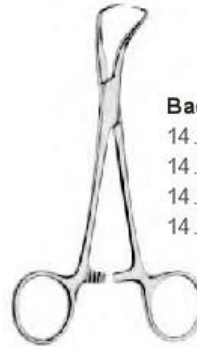

**Backhaus**  
14.771 9,0 cm/3½"  
14.772 11,0 cm/4½"  
14.773 13,0 cm/5"  
14.774 15,0 cm/6"

Tupferzangen  
Cotton Swab Forceps  
Pinces à tampons  
Pinzas para tampones



**Collin**  
25,0 cm/10"  
14.871



**Cheror**  
25,0 cm  
14.873

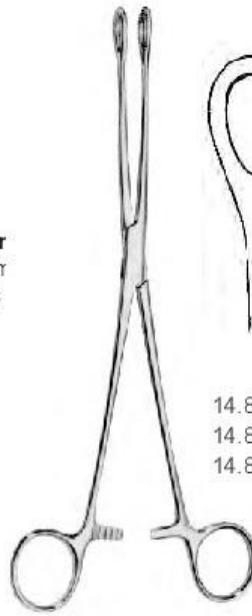

**Foerster**



14.881  
14.882  
14.883



14.884  
14.885  
14.886



18,0 cm/7"  
20,0 cm/8"  
25,0 cm/10"



14.887  
14.888  
14.889

14.890  
14.891  
14.892

**Dermatologie**  
**Dermatology**  
**Dermatologie**  
**Dermatologia**

Häkchen, Lupus löffel  
Hooklets, Lupus curettes  
Crochets, Curettes pour les lupus  
Ganchos, Curettas para lupus



Lupusküretten  
Lupus curettes  
Curettes pour le lupus  
Curettas para lupus

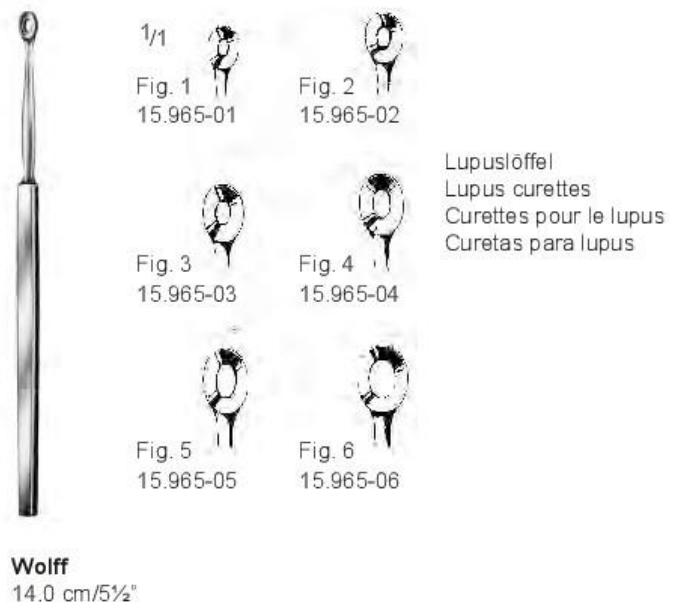
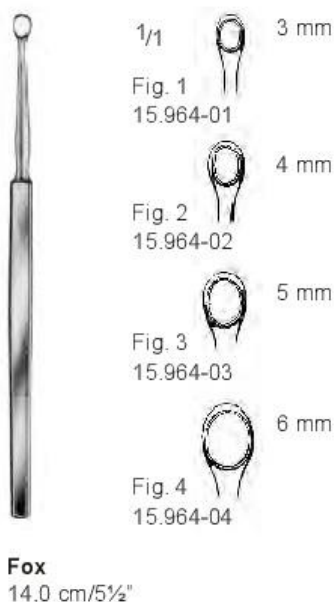

**Messer, Skalpelle**  
**Knives, Scalpels**  
**Couteaux, Bistouris**  
**Cuchillos, Bisturías**

Skalpelle-Griffe  
Scalpel Handles  
Manches pour Bistouris  
Mangos de Bisturías



**Standard**  
16.1091  
No. 3  
massiv  
solid  
massif  
macizo



16.1092  
No. 3L  
massiv  
solid  
massif  
macizo



16.1092G  
No. 3L  
massiv , abgewinkelt  
solid, angular  
massif, coudé  
macizo , acodado



**Standard**  
16.1095  
No. 4  
massiv  
solid  
massif  
macizo



16.1096  
No. 4L  
massiv  
solid  
massif  
macizo



16.1096G  
No. 4L  
massiv , abgewinkelt  
solid, angular  
massif, coudé  
macizo , acodado

**Rektum Instrumente  
Rectal Instruments  
Instruments Rectaux  
Instrumentos Rectales**

Anal spreizer  
Anal retractors  
Ecarteurs rectaux  
Separadores rectales



**Alan Parks**

17.1220-00  
13,5 cm/13¼"



**Sims  
(Bodenhammer)**

15,0 cm/6"

17.1224-01

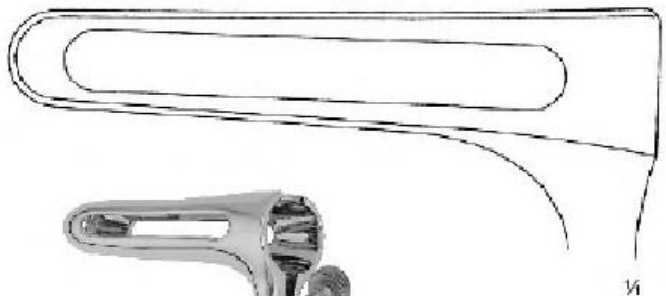

**Sims**

15,0 cm/6"

17.1224-02

**Neurochirurgie und Laminektomie**  
**Neurosurgery and Laminectomy**  
**Neurochirurgie et Laminectomie**  
**Neurocirugía y Laminectomía**

Wirebelkorperspreizer  
Lamina spreaders  
Ecarteurs pour corps vertebraux  
Separadores para cuerpos vertebrales



**Cloward**

18.1345-16  
16,0 cm/6 1/2"

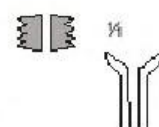
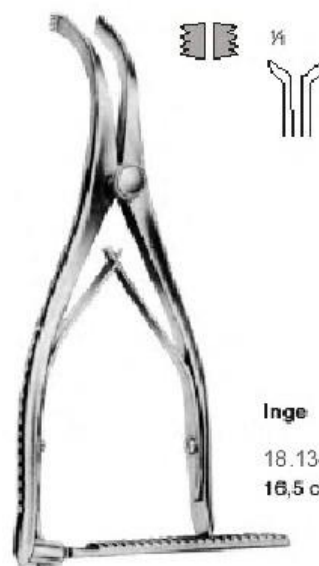

**Inge**

18.1345-17  
16,5 cm/6 1/2"

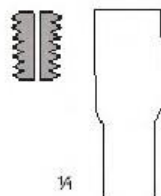
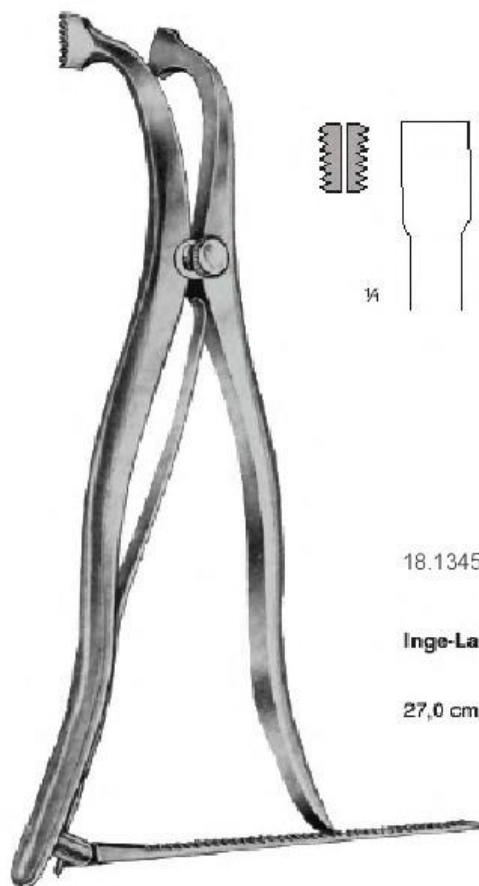

18.1345-27

**Inge-Lamina**

27,0 cm/10 3/4"

Laminektomie-zangen  
Laminectomy rongeurs  
Pinces emporte-leces a laminectomie  
Pinzas cortantes para laminectomia

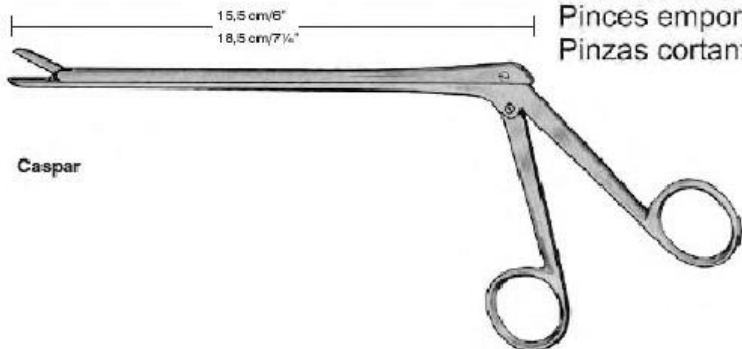

Caspar



	2 x 12 mm	3 x 12 mm	4 x 14 mm
15,5 cm/6"	18.1442-02	18.1442-03	18.1442-04
18,5 cm/7 1/4"	18.1443-02	18.1443-03	18.1443-04



	2 x 12 mm	3 x 12 mm	4 x 14 mm
15,5 cm/6"	18.1444-02	18.1444-03	18.1444-04
18,5 cm/7 1/4"	18.1445-02	18.1445-03	18.1445-04



	2 x 12 mm	3 x 12 mm	4 x 14 mm
15,5 cm/6"	18.1446-02	18.1446-03	18.1446-04
18,5 cm/7 1/4"	18.1447-02	18.1447-03	18.1447-04

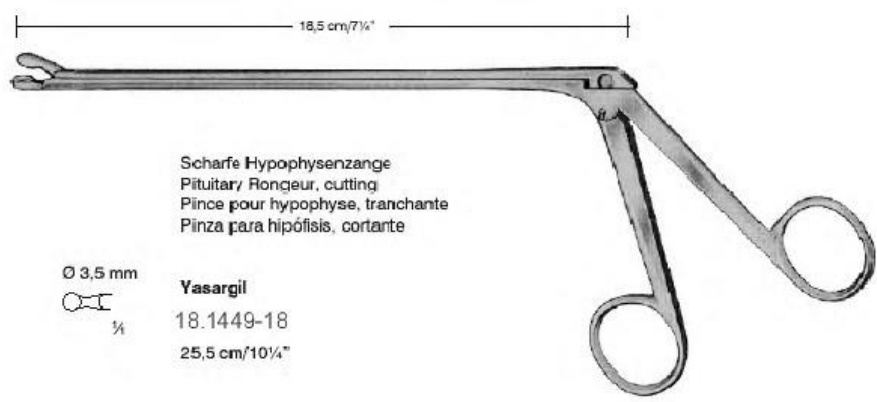

Scharfe Hypophysenzange  
Pituitary Rongeur, cutting  
Pince pour hypophyse, tranchante  
Pinza para hipofisis, cortante



**Yasargil**  
18.1449-18  
25,5 cm/10 1/4"

Bandscheiben-rongeur  
Intervertebral disc rongeurs  
Pincas a discos vertebrales  
Pinzas para discos vertebrales

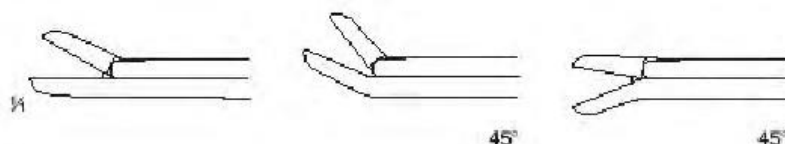
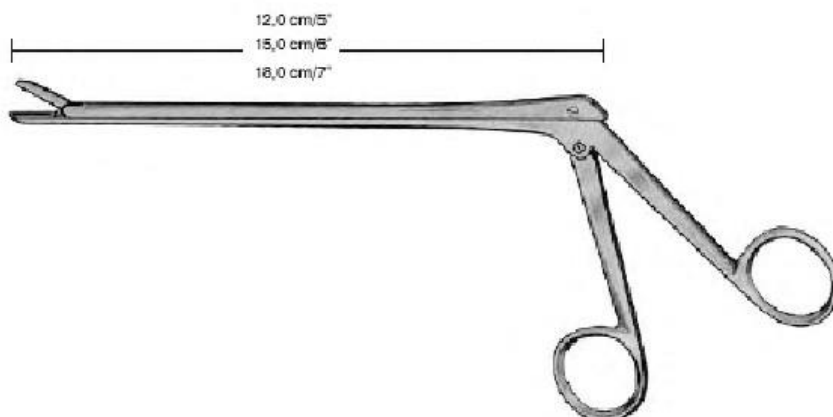

**Cushing**  
2 x 10mm

12,0 cm/5"	18.1450-12	18.1451-12	18.1452-12
15,0 cm/6"	18.1450-15	18.1451-15	18.1452-15
18,0 cm/7"	18.1450-18	18.1451-18	18.1452-18

**Love-Gruenwald**  
3 x 10mm

12,0 cm/5"	18.1460-12	18.1461-12	18.1462-12
15,0 cm/6"	18.1460-15	18.1461-15	18.1462-15
18,0 cm/7"	18.1460-18	18.1461-18	18.1462-18

**Spurling**  
4 x 10mm

12,0 cm/5"	18.1470-12	18.1471-12	18.1472-12
15,0 cm/6"	18.1470-15	18.1471-15	18.1472-15
18,0 cm/7"	18.1470-18	18.1471-18	18.1472-18

Bandscheiben-rongeure  
 Intervertebral disc rongeurs  
 Pincas a discos vertebrales  
 Pinzas para discos vertebrales

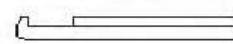
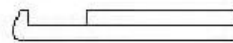
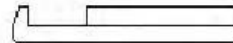
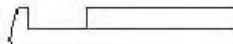
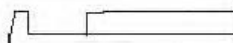
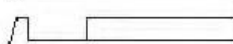

**Ferris-Smith-Kerrison**

	90° nach oben schneidend 90° upwards cutting coupante vers le haut 90° cortante hacia arriba 90°	Bissbreite Width of bite Grandeur de coupe Ancho de la boca	reguläres Modell regular pattern modèle regulier modelo regular		zerlegbares Modell dismantable pattern modèle démontable modelo desmontable	
			Schaftlänge , Length of shaft Longueur de tige, Largo del asta	Schaftlänge , Length of shaft Longueur de tige, Largo del asta	Schaftlänge , Length of shaft Longueur de tige, Largo del asta	Schaftlänge , Length of shaft Longueur de tige, Largo del asta
1/4 □		1 mm	18.1480-01	18.1481-01	18.1486-01	18.1487-01
□		2 mm	18.1480-02	18.1481-02	18.1486-02	18.1487-02
□		3 mm	18.1480-03	18.1481-03	18.1486-03	18.1487-03
□		4 mm	18.1480-04	18.1481-04	18.1486-04	18.1487-04
□		5 mm	18.1480-05	18.1481-05	18.1486-05	18.1487-05
□		6 mm	18.1480-06	18.1481-06	18.1486-06	18.1487-06

	40° nach oben schneidend 40° upwards cutting coupante vers le haut 40° cortante hacia arriba 40°	Bissbreite Width of bite Grandeur de coupe Ancho de la boca	reguläres Modell regular pattern modèle regulier modelo regular		zerlegbares Modell dismantable pattern modèle démontable modelo desmontable	
			Schaftlänge , Length of shaft Longueur de tige, Largo del asta	Schaftlänge , Length of shaft Longueur de tige, Largo del asta	Schaftlänge , Length of shaft Longueur de tige, Largo del asta	Schaftlänge , Length of shaft Longueur de tige, Largo del asta
1/4 □		1 mm	18.1482-01	18.1483-01	18.1488-01	18.1489-01
□		2 mm	18.1482-02	18.1483-02	18.1488-02	18.1489-02
□		3 mm	18.1482-03	18.1483-03	18.1488-03	18.1489-03
□		4 mm	18.1482-04	18.1483-04	18.1488-04	18.1489-04
□		5 mm	18.1482-05	18.1483-05	18.1488-05	18.1489-05
□		6 mm	18.1482-06	18.1483-06	18.1488-06	18.1489-06

Bandscheiben-rongeure  
Intervertebral disc rongeurs  
Pincas a discos vertebrales  
Pinzas para discos vertebrales

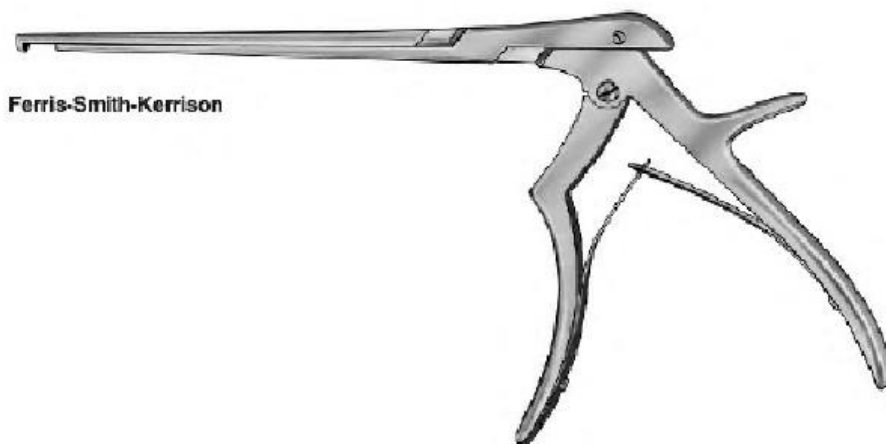

Ferris-Smith-Kerrison

		Bißbreite Width of bite Grandeur de coupe Ancho de la boca	Schaftlänge , Length of shaft Longueur de tige, Largo del asta	
			18,0 cm/7"	20,0 cm/8"
1/2		1 mm	18.1484-01	18.1485-01
		2 mm	18.1484-02	18.1485-02
		3 mm	18.1484-03	18.1485-03
		4 mm	18.1484-04	18.1485-04
		5 mm	18.1484-05	18.1485-05
		6 mm	18.1484-06	18.1485-06

## Verschiedene Nagelinstrumente Miscellaneous Nail Instruments Instruments divers pour les ongles Instrumentos diversos para las uñas

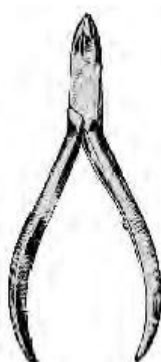

19.1629  
10,5 cm/4¼"  
Hautzange  
Cuticle Nippers  
Pince à envies  
Pinza para cuticulares



19.1630  
14,5 cm/5¾"  
Pedicure-Zange  
Nail Nippers  
Pincés à ongles  
Alicates corta-uñas



19.1631  
14,5 cm/5¾"  
Kopfschneider  
Nail Nippers  
Pincés à ongles  
Alicates corta-uñas



19.1632  
13,0 cm/5"  
Nagelzange  
Nail Nippers  
Pincés à ongles  
Alicates corta-uñas



19.1633  
12,0 cm/4¾"  
Nagelzange  
Nail Nippers  
Pincés à ongles  
Alicates corta-uñas



19.1634 12,0 cm/4¾"  
19.1635 13,5 cm/5¼"  
Nagelzange  
Nail Nippers  
Pincés à ongles  
Alicates corta-uñas



19.1636  
13,0 cm/5"  
Nagelzange  
Nail Nippers  
Pincés à ongles  
Alicates corta-uñas



Nagelschere  
Nail Scissors  
Ciseaux à ongles  
Tijeras para uñas

19.1638 9,0 cm/3½"  
19.1639 10,5 cm/4½"  
gebogen  
curved  
courbes  
curvas



Nagelschere  
Nail Scissors  
Ciseaux à ongles  
Tijeras para uñas

19.1640 9,0 cm/3½"  
curvas



19.1641  
17,0 cm/6¾"  
Fingerring-Säge  
Finger Ring Saw  
Scie pour bagues  
Sierra para abrir anillos

**Scheren, Supercut-Scheren**  
**Scissors, Supercut Scissors**  
**Ciseaux, Ciseaux Supercut**  
**Tijeras, Tijeras Supercut**

Chirurgische scheren  
Operating scissors  
Ciseaux a chirurgie  
Tijeras para cirugía



**Standard**



Fig.1

20.1701  
20.1702  
20.1703  
20.1704  
20.1705  
20.1706  
20.1707  
20.1708  
20.1709



Fig.2

20.1711  
20.1712  
20.1713  
20.1714  
20.1715  
20.1716  
20.1717  
20.1718  
20.1719



Fig.3

20.1721  
20.1722  
20.1723  
20.1724  
20.1725  
20.1726  
20.1727  
20.1728  
20.1729



**Standard**

10,5cm  
11,5cm  
13,0cm  
14,5cm  
15,5cm  
16,5cm  
17,5cm  
18,5cm  
20,0cm



Fig.4

20.1731  
20.1732  
20.1733  
20.1734  
20.1735  
20.1736  
20.1737  
20.1738  
20.1739



Fig.5

20.1741  
20.1742  
20.1743  
20.1744  
20.1745  
20.1746  
20.1747  
20.1748  
20.1749



Fig.6

20.1751  
20.1752  
20.1753  
20.1754  
20.1755  
20.1756  
20.1757  
20.1758  
20.1759



**Brazil**



Fig.1

20.1761  
20.1762



Fig.2

20.1763  
20.1764



Fig.3

20.1765  
20.1766



**Brazil**

13,0cm  
14,5cm



Fig.4

20.1767  
20.1768



Fig.5

20.1769  
20.1770



Fig.6

20.1771  
20.1772

Praparier scheren  
Dissecting scissors  
Ciseaux a dissection  
Tijeras para preparaciones



**Mayo**

20.1791 14,5cm  
20.1792 15,0cm  
20.1793 17,0cm  
20.1794 23,0cm



20.1796  
20.1797  
20.1798  
20.1799



**Mayo-Stillie**

20.1801 15,0cm 20.1803  
20.1802 17,0cm 20.1804  
20.1802-21 21,0cm 20.1804-21

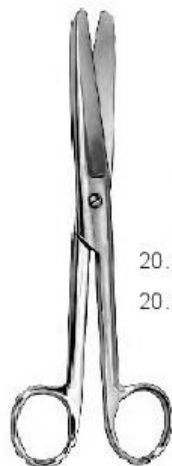

Bauchdecken-Scheren  
Abdominal Scissors  
Ciseaux abdominaux  
Tijeras abdominales

20.1812  
20.1814

**Doyen**



20.1813  
20.1815



20.1817

**Mayo-Lexer**



20.1818



20.1819

**Baby-Lexer**



20.1820

Praparier scheren  
Dissecting scissors  
Ciseaux a dissection  
Tijeras para preparaciones



**Metzenbaum**  
14,5 cm/5½"

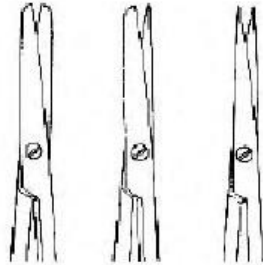

**Fig. 1** 20.1821  
**Fig. 2** 20.1831  
**Fig. 3** 20.1841



**Metzenbaum**  
14,5 cm/5½"

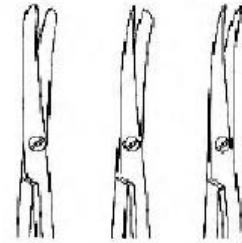

**Fig. 1** 20.1851  
**Fig. 2** 20.1861  
**Fig. 3** 20.1871



**Metzenbaum**

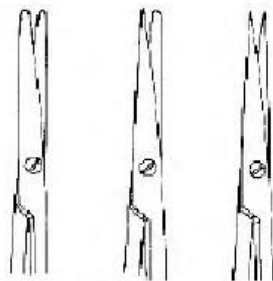

Fig.1	Fig.2	Fig.3
20.1822	20.1832	20.1842
20.1823	20.1833	20.1843
20.1824	20.1834	20.1844
20.1825	20.1835	20.1845
20.1826	20.1836	20.1846
20.1827	20.1837	20.1847



**Metzenbaum**

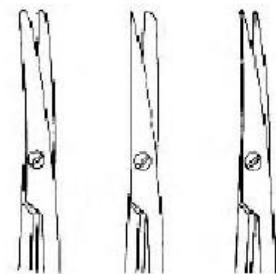

Fig.4	Fig.5	Fig.6	
18,0 cm/7"	20.1852	20.1862	20.1872
20,0 cm/8"	20.1853	20.1863	20.1873
23,0 cm/9"	20.1854	20.1864	20.1874
25,0 cm/10"	20.1855	20.1865	20.1875
26,0 cm/11"	20.1856	20.1866	20.1876
30,0 cm/12"	20.1857	20.1867	20.1877

Chirurgische und gynakologis scheren  
Operating and gynecological scissors  
Ciseaux a chirurgie et a gynecologie  
Tijeras para cirugía y ginecología



**Sims**

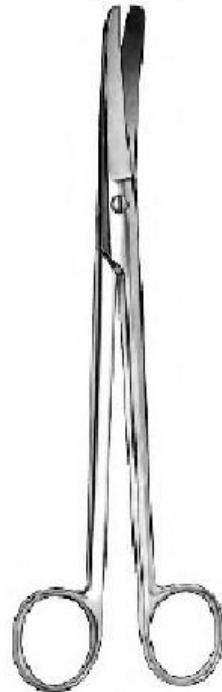

Fig.1  
20.1893  
20.1895

20,0cm  
23,0cm



Fig.2  
20.1896  
20.1898



**Sims**



Fig.1  
20.1899  
20.1901

20,0cm  
23,0cm



Fig.2  
20.1902  
20.1904



20.1916

Feine Chirurgische Scheren  
Delicate Operating Scissors  
Ciseaux chirurgicaux fins  
Tijeras finas para cirugía

**Joseph**  
14,5 cm/5½"



20.1917



**Kilner**

20.1918 13,0 cm/5"  
20.1919 15,0 cm/6"

Präparierscheren  
Dissecting Scissors  
Ciseaux à dissection  
Tijeras para preparaciones

GafaB scheren  
Vascular scissors  
Ciseaux vasculaires  
Tijeras vasculares



**Potts-Smith**  
19,0 cm/7½"

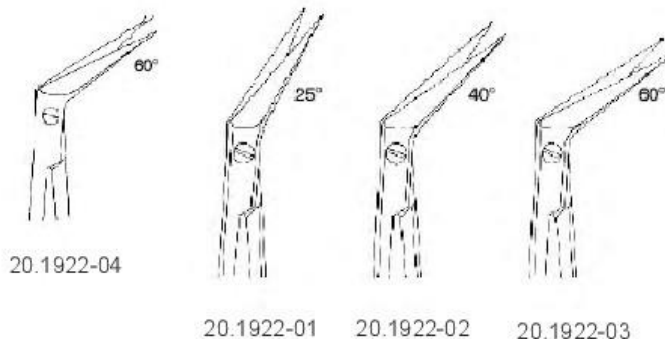

20.1922-04

20.1922-01

20.1922-02

20.1922-03



20.1923

**Potts-Smith**

19,0 cm/7½"



20.1924

**Reynolds**

10,0 cm/0¼"



20.1925 24,5cm

**Satinsky**



20.1926  
19,0 cm

**Mc Indoe**



20.1927

**Tönnis**  
18,0 cm/7"



20.1928

Ligatur-und draht scheren  
Ligature scissors and wire cutting scissors  
Ciseaux a ligatures, coupe-fils alambre  
Tijeras para ligaduras, cizallas para cortar alamre



20.1945

**Ligatureschere**  
11,5 cm/4½"



20.1946



**Littauer**  
20.1947 14,0 cm/5½"

gebogen, curved  
courbes, curvas

20.1948G 9,0 cm/3½"  
20.1950G 12,0 cm/4¾"



**Spencer**  
20.1948 9,0 cm/3½"  
20.1949 10,5 cm/4"  
20.1950 12,0 cm/4¾"

**Drahtschere**  
Wire Cutting Scissors  
Coupe-fils alambre  
Cizallas para cortar alambre



**Heath**  
20.1951  
15,0 cm/6"



**Universal**  
20.1952  
12,0 cm/4¾"



20.1954

**Sistrunk**  
13,0 cm/5"



20.1955



20.1956-15  
15,0 cm/6"

**Nagelspalt-Scheren, Nail Splitting Scissors**  
Ciseaux à fendre les ongles, Tijeras para hender las uñas

Supercut scheren  
Supercut scissors  
Ciseaux supercut  
Tijeras supercut



20.1791-SC  
20.1793-SC

**Mayo**  
14,5 cm/5½"  
17,0 cm/6¾"



20.1796-SC  
20.1798-SC



20.1801-SC  
20.1802-SC

**Mayo-Stillie**  
15,0 cm/6"  
17,0 cm/6¾"



20.1803-SC  
20.1804-SC



20.1817-SC

**Mayo-Lexer**  
10,0 cm/0¾"



20.1818-SC



20.1821-SC

**Metzenbaum**  
14,5 cm/5½"



20.1851-SC

**Metzenbaum**  
14,5 cm/5½"



20.1822-SC

**Metzenbaum**  
18,0 cm/7"



20.1852-SC

**Metzenbaum**  
18,0 cm/7"



Supercut scheren  
Supercut scissors  
Ciseaux supercut  
Tijeras supercut



20.1880-SC

**Metzenbaum, Fino**  
14,5 cm/5½"



20.1884-SC



**Metzenbaum  
(Strabismus)**  
11,5 cm/4½"

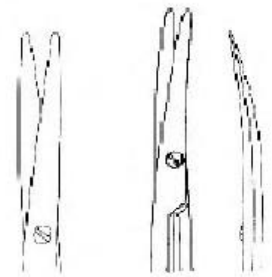

20.1888-SC

20.1889-SC



**Lister**

20.1979-SC 14,0 cm/5½"  
20.1980-SC 18,0 cm/7"  
20.1981-SC 20,0 cm/8"



**Irisschere**  
11,5 cm/4½"

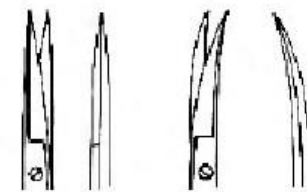

20.7458-SC

20.7459-SC



**Stevens**  
11,0 cm/4½"  
stumpf  
blunt  
mousses  
romas

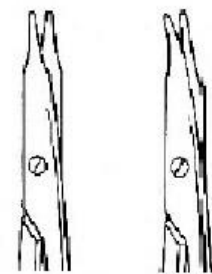

20.7496-SC

20.7497-SC

**Instrumente für Verband und Gips**  
**Bandage and Plaster Instruments**  
**Instrumentes pour pansements et plâtre**  
**Instrumentos para vendajes y yeso**

Verband scheren  
Bandage scissors  
Ciseaux pour pansements  
Tijeras para vendajes



**Smith**

21.1971 16,0 cm/6¼"  
21.1972 18,0 cm/7"  
21.1973 20,0 cm/8"  
21.1974 23,0 cm/9"

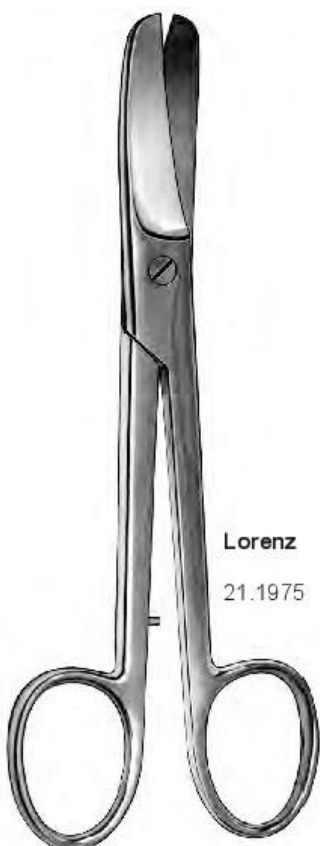

**Lorenz**

21.1975 23,0 cm/9"



**Knowles**

14,5 cm/5½"

21.1976

gerade, straight  
droits, rectas

21.1976G

gebogen, curved  
courbes, curvas



**Lister**

21.1977 9,0 cm/3½"  
21.1978 11,0 cm/4½"  
21.1979 14,0 cm/5½"  
21.1980 18,0 cm/7"  
21.1981 20,0 cm/8"



**Esmarch**

21.1982 20,0 cm/8"  
21.1983 23,0 cm/9"



**Bruns**

24,0 cm/9½"

21.1984

lisses, lisas

21.1985

dentadas



**Bergmann**

23,0 cm/9"

21.1988

Gips scheren  
Plaster of paris shears  
Ciseaux pour pansements et plâtre  
Tijeras para vendajes



**Seutin**

21.1990 23,0 cm/9"

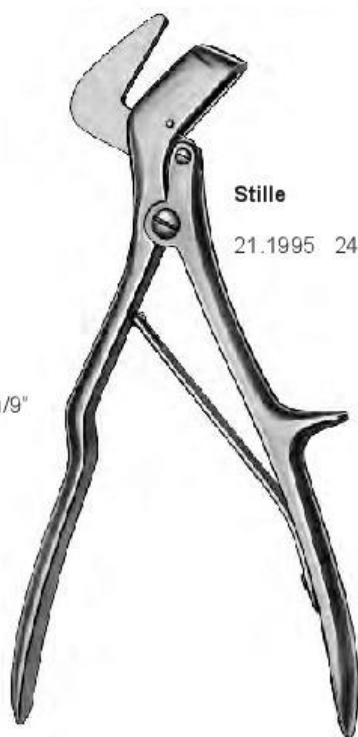

**Stille**

21.1995 24,0 cm/9½"



**Stille**

21.1996 23,0 cm/9"  
21.1997 26,0 cm/10½"  
21.1998 37,0 cm/14½"



**Wolff**

21.2032 18,0 cm/7"  
21.2033 24,0 cm/9½"



**Henning**

21.2034 28,0 cm/11"

# Instrumente mit Hartmetalleinlagen Instruments with Tungsten Carbide Inserts Instruments avec mors carbure de tungstène Instrumentos con placas de carburo tungsteno

Anatomische pinzetten mit hartmetall-einsätzen  
Dressing forceps with t/c jaws  
Pincès à disséquer avec mors en carbure de tungstène  
Pinzas de disección con boca de carburo de tungsteno

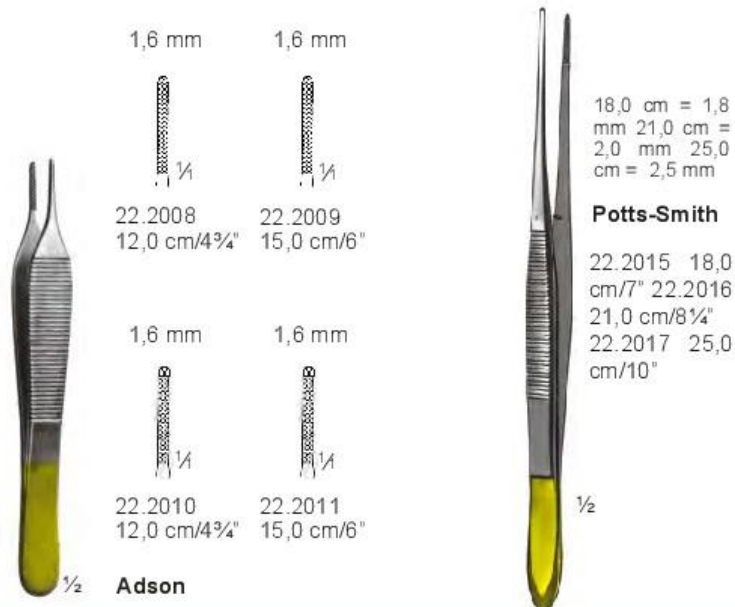

Augen nadel halter mit hartmetall-einsätzen  
Eye needle holders with t/c jaws  
Porte-aiguilles pour mors en carbure de tungstène  
Porta-agujas con boca de carburo de tungsteno

ohne Sperre, without ratchet  
sans crémaillère, sin cremallera



22.2095-14 14,0 cm/5½"  
gerade  
straight  
droite  
recta



22.2096-14  
gebogen  
curved  
courbe  
curva



22.2097-14 14,0 cm/5½"  
gerade  
straight  
droite  
recta



22.2098-14  
gebogen  
curved  
courbe  
curva



Castroviejo

mit Sperre, with ratchet  
avec crémaillère, con cremallera



22.2099-14 14,0 cm/5½"  
22.2099-18 18,0 cm/7"  
22.2099-21 21,0 cm/8¼"  
gerade  
straight  
droite  
recta



22.2100-14  
22.2100-18  
22.2100-21  
gebogen  
curved  
courbe  
curva



22.2101-14 14,0 cm/5½"  
22.2101-18 18,0 cm/7"  
22.2101-21 21,0 cm/8¼"  
gerade  
straight  
droite  
recta



22.2102-14  
22.2102-18  
22.2102-21  
gebogen  
curved  
courbe  
curva



Barraquer  
13,5 cm/5¼"

22.2110 gerade  
straight  
droite  
recta  
22.2111 gebogen  
curved  
courbe  
curva



French

22.2113 13,0 cm/5"  
22.2114 14,5 cm/5½"  
22.2115 16,0 cm/6¼"  
22.2116 18,0 cm/7"  
22.2117 20,0 cm/8"  
22.2118 23,0 cm/9"  
22.2119 26,0 cm/10¼"



Derf

22.2192 12,5 cm/5"



Mayo-Hegar

22.2199 30,0 cm/12"

Nadelhalter mit hartmetall-einsätzen  
Needle holders with t/c jaws  
Porte-aiguilles pour mors en carbure de tungstène  
Porta-agujas con boca de carburo de tungsteno



0,5 mm

**Mayo-Hegar**

- 22.2200 14,0 cm/5½"
- 22.2201 16,0 cm/6¼"
- 22.2202 18,0 cm/7¼"
- 22.2203 20,0 cm/8"
- 22.2204 23,0 cm/9"
- 22.2205 26,0 cm/10¼"



**Olsen-Hegar**

22.2208 14,0 cm/5½"



**Olsen-Hegar**

22.2209 17,0  
cm/6¼"



**Olsen-Hegar**

22.2210 18,0  
cm/7"



**Finochietto**

- 22.2212 26,0 cm/10¼"
- 22.2213 20,0 cm/8"



**Baumgartner**

22.2214 13,0 cm/5"



**Crile-Wood**

- 22.2215 15,0 cm/6"
- 22.2216 18,0 cm/7"
- 22.2217 20,0 cm/8"
- 22.2218 23,0 cm/9"
- 22.2228 26,0 cm/10¼"

Nadelhalter mit hartmetall-einsätzen  
Needle holders with t/c jaws  
Porte-aiguilles pour mors en carbure de tungstène  
Porta-agujas con boca de carburo de tungsteno



**De Bakay**

- 22.2216D 18,0 cm/7"
- 22.2217D 20,0 cm/8"
- 22.2218D 23,0 cm/9"
- 22.2228D 26,0 cm/10¼"



**Heaney**

- 22.2219 20,0 cm/8"
- 22.2220 26,0 cm/10¼"



**Mathieu**

- 22.2222 14,0 cm/5½"
- 22.2223 17,0 cm/6½"
- 22.2224 20,0 cm/8"

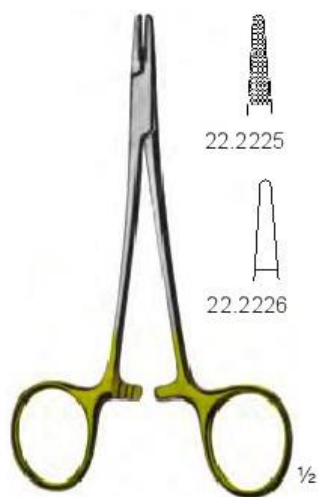

**Halsey**

13,0 cm/5"



**Webster**

22.2227 13,0 cm/5"



**Sarot**

- 22.2240 18,0 cm/7"
- 22.2241 20,0 cm/8"
- 22.2242 26,0 cm/10¼"



**Masson**

22.2244 27,0 cm/10½"

Gewebefab zangen mit hartmetall-einsätzen  
Tissue seizing forceps with t/c jaws  
Pincés à saisir les tissus en carbure de tungstène  
Pinzas para cojer tejidos con boca de carburo de tungsteno



Gewebefaßzange  
Tissue Seizing Forceps  
Pince à saisir les tissus  
Pinza para coger tejidos

**Duval**

22.2254 20,0 cm/8"



**Babcock**

22.2255 16,0 cm/6¼"  
22.2256 20,0 cm/8"



**Allis**

22.2257 16,0 cm/6¼"  
22.2258 19,0 cm/7½"

Scheren mit hartmetall-einsätzen  
Scissors with tungsten carbide edges  
Ciseaux avec tranchants en carbure de tungstène  
Tijeras con cortantes de carburo de tungsteno



**Standard**  
14,5 cm/5½"

½



**Standard**  
14,5 cm/5½"



Fig. 1  
22.2260



Fig. 2  
22.2261



Fig. 3  
22.2262

gerade  
straight  
droits  
rectas

gebogen  
curved  
courbes  
curvas

22.2263

22.2264

22.2265



**Lister**

22.2269

18,0 cm/7"

½



**Mayo**

22.2270 14,5 cm  
22.2271 17,0 cm

½



**Mayo**

22.2272  
22.2273



**Mayo-Style**

22.2274 15,0 cm  
22.2275 17,0 cm

½



**Mayo-Style**

22.2276  
22.2277



Scheren mit hartmetall-einsätzen  
Scissors with tungsten carbide edges  
Ciseaux avec tranchants en carbure de tungstène  
Tijeras con cortantes de carburo de tungsteno



22.2278-02  
curvas

**Mayo-Lexer**  
16,5 cm/6½"  
22.2278-01  
rectas



22.2279-01 22.2279-02  
**Strabismus (Metzenbaum)**  
11,5 cm/4½"

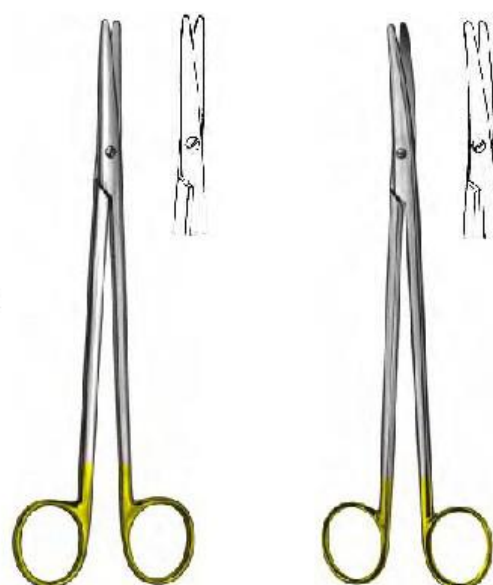

**Metzenbaum**  
22.2280 14,5 cm/5½" 22.2284  
22.2281 18,0 cm/7" 22.2285  
22.2282 20,0 cm/8" 22.2286  
22.2283 23,0 cm/9" 22.2287



**Metzenbaum, Fino**  
22.2280F 14,5 cm/5½" 22.2284F  
22.2281F 18,0 cm/7" 22.2285F  
22.2282F 20,0 cm/8" 22.2286F  
22.2283F 23,0 cm/9" 22.2287F



**Tönnis-Adson**  
22.2288 17,0 cm/7"



**Irisschere**  
11,5 cm/4¾"

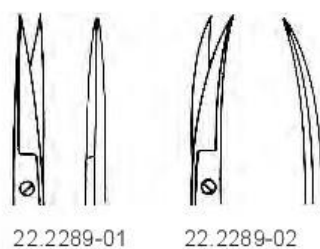

22.2289-01 22.2289-02

Drahtkneifzangen mit hartmetall-einsätzen  
Wire and pin cutters with tungsten carbide inserts  
Pincés à couper le fil en carbure de tungstène  
Alicates para cortar alambre de carburo de tungsteno



Universal

22.2290 12,0 cm/5"

22.2291 12,5 cm/5"

22.2292 17,5 cm/7"

22.2293 22,0 cm/8¾"

für Drähte bis 1,6 mm Ø  
for wires up to 1,6 mm Ø  
pour fils jusqu'à 1,6 mm Ø  
para hilos hasta 1,6 mm Ø

für Drähte bis 2,5 mm Ø  
for wires up to 2,5 mm Ø  
pour fils jusqu'à 2,5 mm Ø  
para hilos hasta 2,5 mm Ø



22.2294-16 16,0 cm/6½"

für Drähte bis 1,6 mm Ø  
for wires up to 1,6 mm Ø  
pour fils jusqu'à 1,6 mm Ø  
para hilos hasta 1,6 mm Ø

18,0 cm/7"



Fig. 1  
22.2296-01



Fig. 2  
22.2296-02



Fig. 3  
22.2296-03



22.2297-18 18,0 cm/7"

für weiche Drähte bis 2,0 mm Ø  
for soft wires up to 2,0 mm Ø  
pour fils mous jusqu'à 2,0 mm Ø  
para hilos blandos hasta 2,0 mm Ø

für harte Drähte bis 1,7 mm Ø  
for hard wires up to 1,7 mm Ø  
pour fils durs jusqu'à 1,7 mm Ø  
para hilos duros hasta 1,7 mm Ø

**Naht  
Suture  
Suture  
Sutura**

Nadel halter  
Needle holders  
Porte-aiguilles  
Porta-agujas



**Collier**

23.2301 12,5 cm/5"

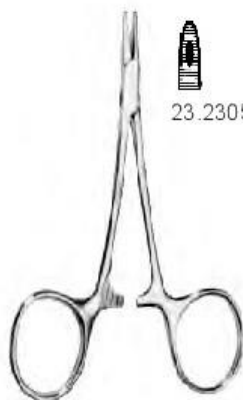

**Derf**

12,5 cm/5"

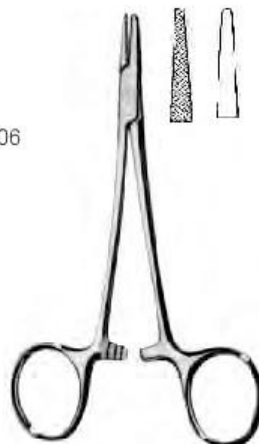
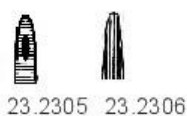

**Halsey**

23.2310 13,0 cm/5" 23.2311  
estriada lisa



**Webster**

23.2312 13,0 cm/5"  
lisa



**Crile-Wood**

23.2314 15,0 cm/6"  
con ranura  
23.2315  
sin ranura



**Brown**

23.2318 13,0 cm/5"  
23.2319 18,0 cm/7"

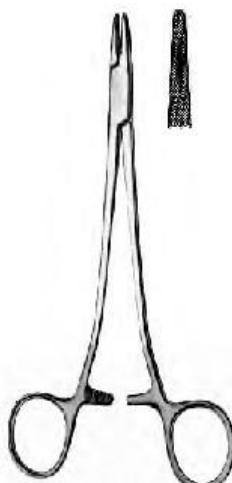

**Sarot**

23.2322 18,0 cm/7¼"  
23.2324 26,0 cm/10¼"



**Mayo-Hegar**

23.2330 14,0 cm/5½" 23.2341  
23.2331 16,0 cm/6¼" 23.2342  
23.2332 18,0 cm/7¼" 23.2343  
23.2333 20,0 cm/8" 23.2344  
23.2334 24,0 cm/9½" 23.2344  
23.2335 26,0 cm/10¼" 23.2345

Nadel halter  
Needle holders  
Porte-aiguilles  
Porta-agujas



**Hegar-Baumgartner**

23.2355 14,0 cm/5½"



**Baby-Olsen-Hegar**  
11,5 cm/4½"

23.2356-01 23.2356-02  
estriada lisa



**Olsen-Hegar**

23.2357 14,0 cm/5½"



**Olsen-Hegar**

23.2358 16,0 cm/6¼"



**Crile**

23.2382 15,0 cm/6"



**Adson**

23.2384 18,0 cm/7"



**Mathieu**

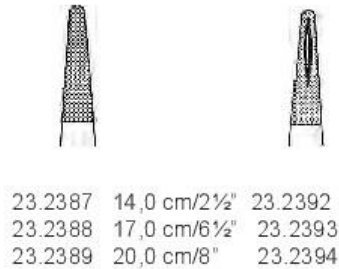

23.2387 14,0 cm/2½" 23.2392  
23.2388 17,0 cm/6½" 23.2393  
23.2389 20,0 cm/8" 23.2394



23.2397 14,0 cm/5½"  
23.2398 17,0 cm/6¾"  
schlankes Maul  
slender jaw  
mors étroit  
boca fina

Augen nadel halter  
Eye needle holders  
Porte-aiguilles pour les yeux  
Porta-agujas para ojos

mit Sperre, with ratchet  
avec crémaillère, con cremallera



23.2405-14 14,0 cm/5½"  
23.2405-18 18,0 cm/7"  
23.2405-21 21,0 cm/8¼"  
gerade  
straight  
droite  
recta



23.2419-14 14,0 cm/5½"  
gerade  
straight  
droite  
recta



23.2406-14  
23.2406-18  
23.2406-21  
gebogen  
curved  
courbe  
curva



23.2420-14  
gebogen  
curved  
courbe  
curva



Castroviejo

ohne Sperre, without ratchet  
sans crémaillère, sin cremallera



23.2407-14 14,0 cm/5½"  
gerade  
straight  
droite  
recta



23.2408-14  
gebogen  
curved  
courbe  
curva



Barraquer

23.2412 13,5 cm/5" 23.2413  
23.2417 18,0 cm/7" 23.2418  
gerade  
straight  
droite  
recta gebogen  
curved  
courbe  
curva

Wundklammer-pinzetten  
Clip applying forceps  
Pincès pour agrafes  
Pinzas para agrafes



Michel (1x2)  
23.2500 12,0 cm/4¾"



Michel  
23.2505 12,0 cm/4¾"



Michel  
23.2511 12,0 cm/4¾"

Wundklammer-Zangen  
Clip Applying Forceps  
Pincès pour agrafes  
Pinzas para agrafes



Collin  
23.2515 13,0 cm/5¼"

# Impfen und Punktion Vaccination and Puncture Vaccination et ponction Vacunación y punción



Magill

Magill-Baby



24.2689

15,0 cm/6"  
für Kleinkinder  
pediatric size  
pour bébés  
para párvulos



24.2690

20,0 cm/8"  
für Kinder  
for children  
pour enfants  
para niños



24.2691

25,0 cm/10"  
für Erwachsene  
for adults  
pour adultes  
para adultos

**Sonden, Watteträger, Spatel, Veneninstrumente**

**Probes, Applicators, Spatulas, Vein Instruments**

**Sondes, Porte-cotons, Spatules, Instruments à varices**

**Sondas, Porta-algodones, Espátulas, Instrumentos para várices**

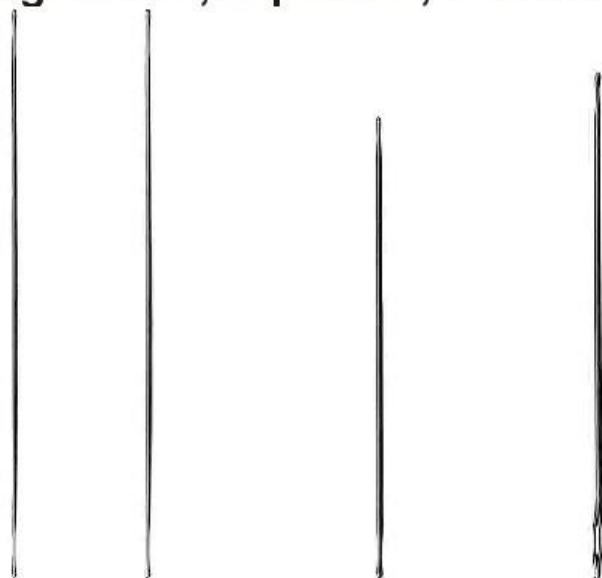

Sonden  
 Probes and directors  
 Stylets et sondes  
 Estiletes y sandas

cm	in.	1,0 mmØ	1,5 mmØ	2,0 mmØ	2,0 mmØ
11,5	4½	25.2701		25.2711	25.2731
13,0	5	25.2703		25.2713	25.2733
14,5	5½	25.2704	25.2715-14	25.2714	25.2734
16,0	6¼	25.2706	25.2715-16	25.2716	25.2736
18,0	7	25.2708	25.2715-18	25.2718	25.2738
20,0	8	25.2710	25.2715-20	25.2720	25.2740
25,0	10			25.2725	25.2745



cm	in.	Stacke	Doyen	Nélaton	
10,5	4¼	25.2760			
11,5	4½	25.2751	25.2761		
13,0	5	25.2753	25.2763	25.2773	
14,0	5½	25.2754	25.2764	25.2774	25.2780
16,0	6¼	25.2756	25.2766	25.2776	25.2781
18,0	7		25.2768		
20,0	8		25.2770		

**Wundhaken, Wundsperrer**  
**Retractors**  
**Ecarteurs**  
**Separadores**

**Wundhaken**  
**Retractors**  
**Ecarteurs**  
**Separadores**



**Cushing**  
20,0 cm/8"



**Cushing**  
24,0 cm/9½"



**Mini-Langenbeck**  
16,0 cm/6½"



Wundhaken  
Retractors  
Ecarteurs  
Separadores



**Volkmann**  
23,0 cm/9"

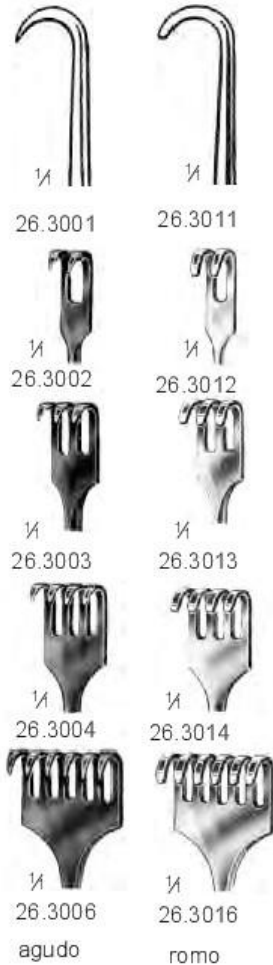

26.3001  
26.3002  
26.3003  
26.3004  
26.3006  
agudo

26.3011  
26.3012  
26.3013  
26.3014  
26.3016  
romo



**Volkmann**  
26.3021  
21,5 cm/8½"

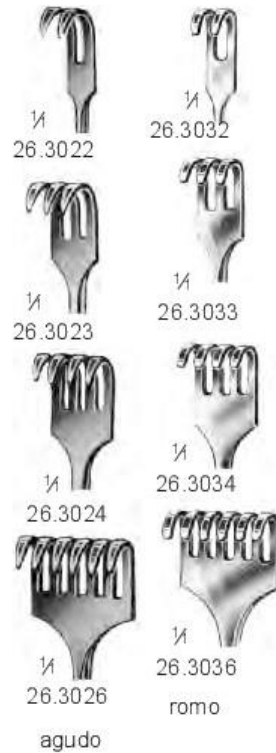

26.3022  
26.3023  
26.3024  
26.3026  
agudo

26.3032  
26.3033  
26.3034  
26.3036  
romo



**Kocher**  
22,0 cm/8½"

scharf  
sharp  
pointu  
agudo

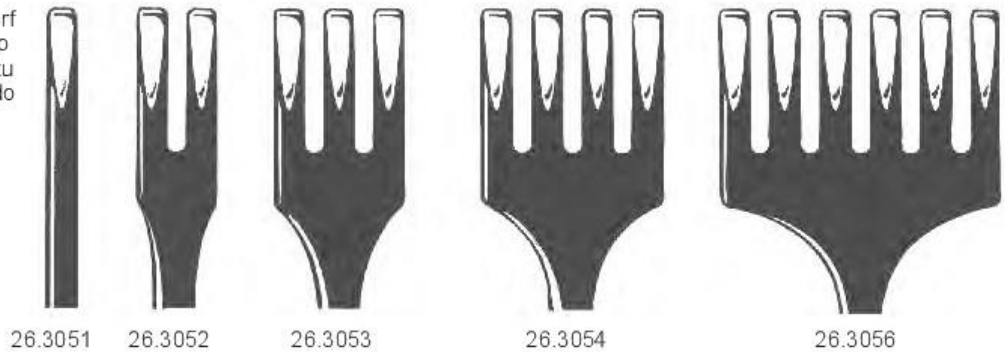

26.3051 26.3052 26.3053 26.3054 26.3056

stumpf  
blunt  
mousse  
romo

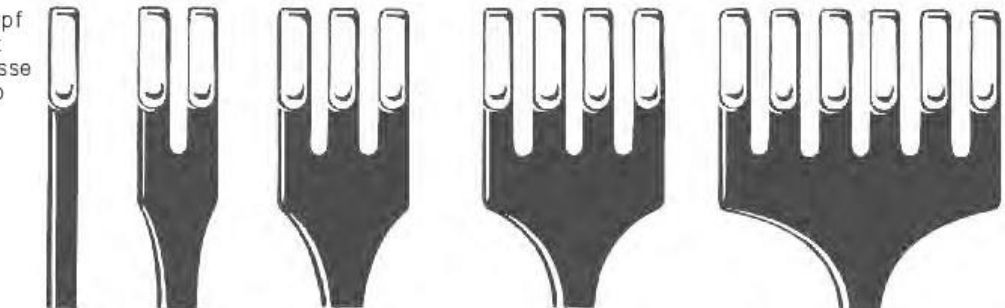

26.3061 26.3062 26.3063 26.3064 26.3066

Wundhaken  
Retractors  
Ecarteurs  
Separadores



Hüftgelenkhaken  
Retractors  
Ecarteurs  
Separadores

1/2

**Langenbeck**  
21,0 cm/8 1/4"

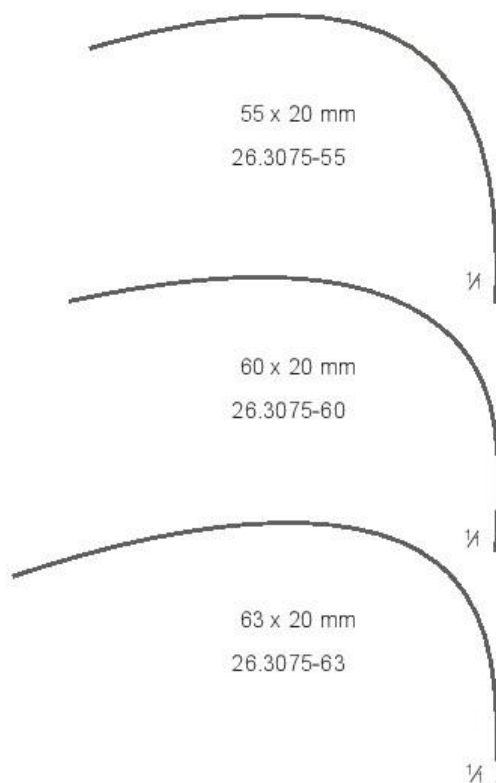

1/2

**Langenbeck**  
21,0 cm/8 1/4"

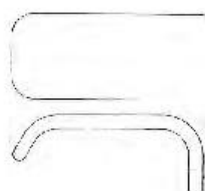

**Kocher**  
21,5 cm/8 1/2"

26.3076 40 x 18 mm  
26.3077 60 x 20 mm  
26.3078 60 x 25 mm  
26.3079 75 x 30 mm  
26.3080 75 x 40 mm



**Langenbeck**  
21,0 cm/8 1/4"

26.3085 30 x 11 mm  
26.3086 30 x 14 mm  
26.3087 30 x 16 mm  
26.3088 40 x 11 mm  
26.3089 50 x 11 mm

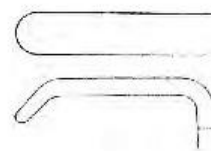

**Kocher-Langenbeck**  
21,5 cm/8 1/2"

26.3090 25 x 6 mm  
26.3091 35 x 8 mm  
26.3092 35 x 11 mm  
26.3093 35 x 15 mm  
26.3094 40 x 11 mm  
26.3095 55 x 11 mm  
26.3096 70 x 14 mm  
26.3097 80 x 12 mm  
26.3098 80 x 16 mm

Wundhaken  
Retractors  
Ecarteurs  
Separadores



26.3081 30 x 11 mm  
26.3082 30 x 14 mm  
26.3083 30 x 16 mm



26.3084 40 x 11 mm

1/2

**Langenbeck**  
22,0 cm/8 3/4"



1/2

**Sauerbruch**

22,5 cm/9"



45 x 15 mm

26.3099-01

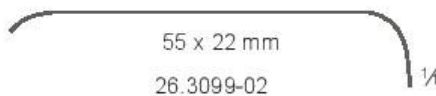

55 x 22 mm

26.3099-02



72 x 19 mm

26.3099-03



1/2

**Doyen**  
25,0 cm/10"

26.3116-80 53 x 80 mm  
26.3116-85 50 x 85 mm



70 x  
25 mm

1/2

**Kocher**  
23,5 cm/9 1/4"

26.3117-23



1/2

**Kocher**  
25,0 cm/10"

26.3118-01 80 x 45 mm  
26.3118-02 80 x 55 mm  
26.3118-03 80 x 65 mm

Wundhaken  
Retractors  
Ecarteurs  
Separadores



**Kelly**  
27,0 cm/10½"

26.3151 190 x 38 mm  
26.3152 190 x 57 mm

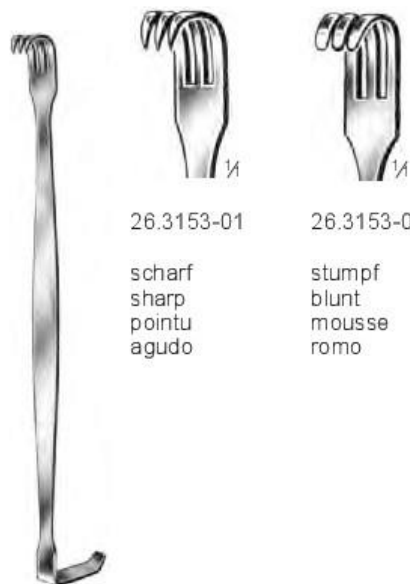

26.3153-01

scharf  
sharp  
pointu  
agudo

26.3153-02

stumpf  
blunt  
mousse  
romo

**Baby-Senn-Miller**  
15,5 cm/6"



8 x 4 mm

15 x 5,5 mm

**Ragnell-Davis**

26.3154  
14,0 cm/5½"

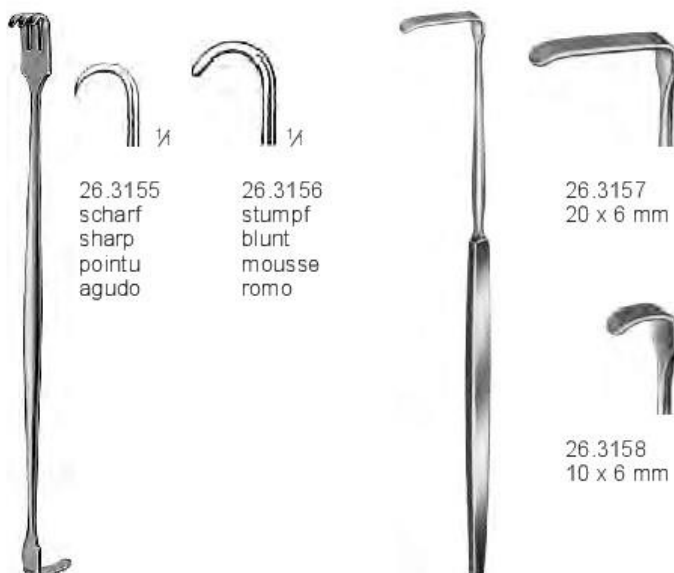

26.3155  
scharf  
sharp  
pointu  
agudo

26.3156  
stumpf  
blunt  
mousse  
romo

26.3157  
20 x 6 mm

26.3158  
10 x 6 mm

**Senn-Miller**  
16,0 cm/6¼"

**Senn-Green**  
15,0 cm/6"

Wundhaken  
Retractors  
Ecarteurs  
Separadores



**Farabeuf**  
12,0 cm/4¾"

26.3160  
Satz, set  
jeu, juego

**Farabeuf**  
15,0 cm/6"

26.3161  
Satz, set  
jeu, juego



**Mathieu**  
20,0 cm/8"

26.3164 juego

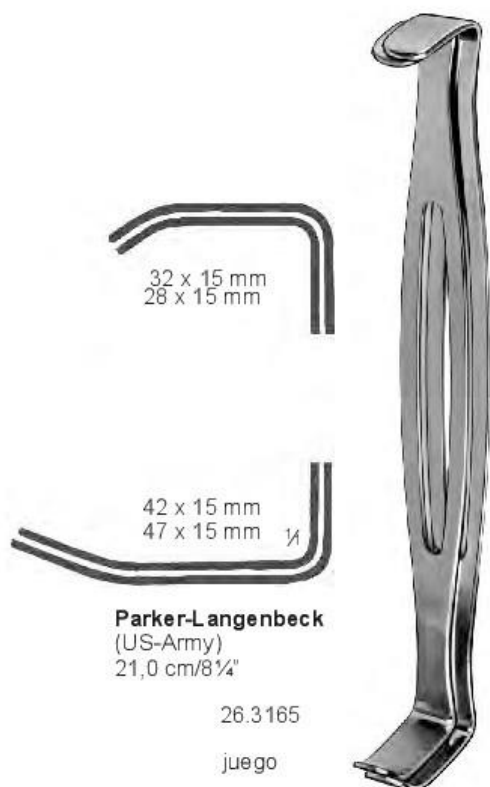

**Parker-Langenbeck**  
(US-Army)  
21,0 cm/8¼"

26.3165

juego

Wundhaken  
Retractors  
Ecarteurs  
Separadores

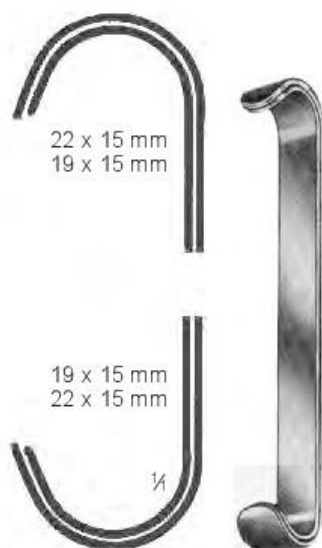

22 x 15 mm  
19 x 15 mm

19 x 15 mm  
22 x 15 mm

**Parker**  
13,5 cm/5¼"

26.3166  
Satz, set  
jeu, juego

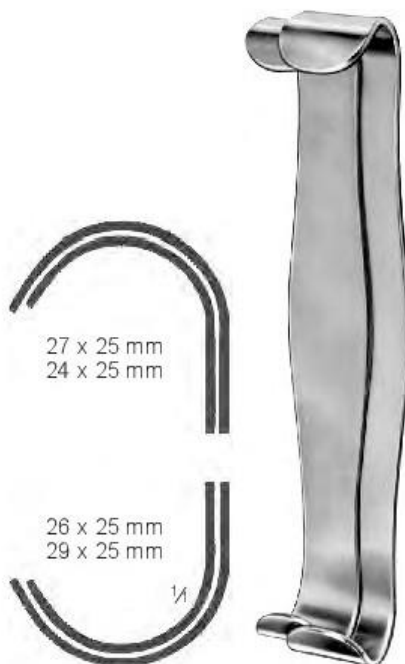

27 x 25 mm  
24 x 25 mm

26 x 25 mm  
29 x 25 mm

**Parker**  
18,0 cm/7"

26.3167  
Satz, set  
jeu, juego

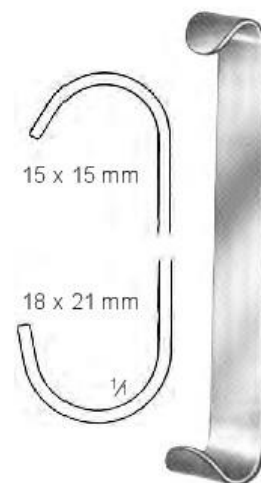

15 x 15 mm

18 x 21 mm

**Baby-Roux**  
13,0 cm/5¼"

26.3168



**Mini-Roux**  
15,0 cm/6"

26.3169

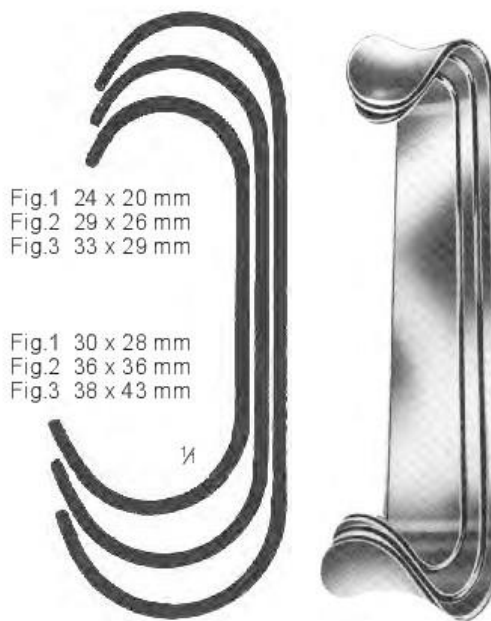

Fig.1 24 x 20 mm  
Fig.2 29 x 26 mm  
Fig.3 33 x 29 mm

Fig.1 30 x 28 mm  
Fig.2 36 x 36 mm  
Fig.3 38 x 43 mm

**Roux**

**Roux**

26.3170-00  
Satz, set  
jeu, juego

Fig.1 26.3171 14,0 cm/5½"  
Fig.2 26.3172 15,0 cm/6"  
Fig.3 26.3173 17,0 cm/6¾"

Wundhaken  
Retractors  
Ecarteurs  
Separadores



**Weitlaner-Loktite**  
10,5 cm/4 1/4"

26.3181  
agudo

26.3191  
romo



**Weitlaner-Loktite**

1/2

26.3183	13,0 cm/5"	26.3193
26.3186	16,5 cm/6 1/2"	26.3196
26.3189	20,0 cm/8"	26.3199
	agudo	romo



**Weitlaner-Wullstein**  
13,0 cm/5"

26.3202-01	26.3202-02
agudo	romo



**Weitlaner-Baby**  
13,0 cm/5"

26.3203

10 mm  
20 mm



**Adson**  
32,0 cm/12 1/2"

18 mm



**Beckmann**  
31,0 cm/12 1/4"



**Adson**  
20,0 cm/8"

26.3222-01  
agudo

26.3222-02  
romo

**Wundspreizer**  
**Abdominal Retractors**  
**Ecarteurs abdominaux**  
**Separadores abdominales**



**Gelpi-Loktite**

26.3345-09 9,0 cm/3½"  
26.3345-11 11,5 cm/4½"



**Gelpi-Loktite**

26.3345-14 14,0 cm/5½"  
26.3345-18 18,0 cm/7"

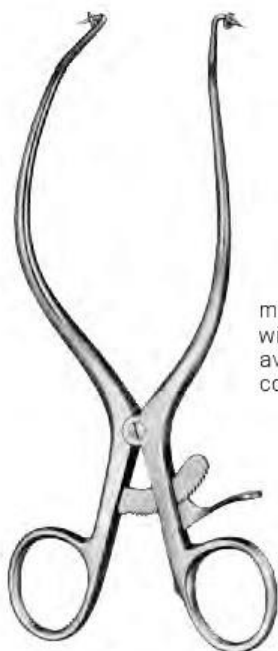

mit Kugel  
with balls  
avec boules  
con bolas

**Gelpi-Loktite**

26.3346-18 18,0 cm/7"



**DeBakey**

26.3348 100 mm  
26.3349 145 mm  
Spreizweite  
Spread  
Ecartement  
Apertura de la hoja

**Knochenchirurgie-Instrumente**  
**Bone Surgery Instruments**  
**Instrumentation pour la Chirurgie Osseuse**  
**Instrumental para la cirugía ósea**

Flachzagen  
Flat nose pliers  
Pinces plates  
Alicates planos



17,0 cm/6¾"



27.3450-01



27.3450-02

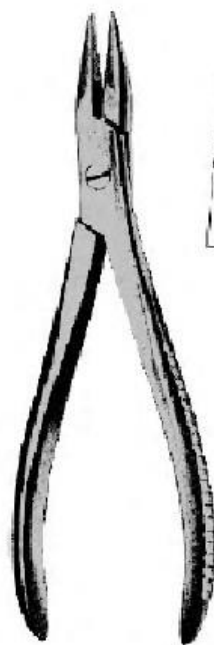

27.3451-19  
19,0 cm/7½"



27.3452-14  
14,0 cm/5½"

spitz  
sharp  
pointu  
agudo

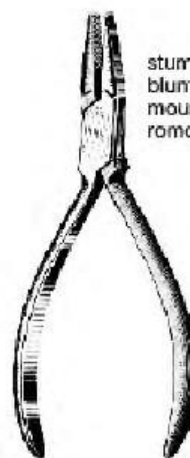

27.3453-14  
14,0 cm/5½"

stumpf  
blunt  
mousse  
romo

Draht zagen  
Wire cutting pliers  
Pincas a fils  
Alicates para cortar alambre



18,0 cm/7"



Fig. 1

27.3454-01



Fig. 2

27.3454-02



Fig. 3

27.3454-03

Flachzangen  
Flat nose pliers  
Pincas plates  
Alicates planos



18,0 cm/7"



Fig. 4

27.3454-04



27.3455-16  
18,0 cm/6 1/4"

Kopfschneider  
Wire cutting pliers  
Pincas à couper le fil  
Alicates para cortar alambre



27.3456-14  
15,0 cm/6"

Kopfschneider  
Wire cutting pliers  
Pincas à couper le fil  
Alicates para cortar alambre

für harten Draht bis 1,5 mm  
for hard wire up to 1,5 mm  
pour fils durs jusqu'à 1,5 mm  
para hilos duros hasta 1,5 mm

Draht zagen  
Wire cutting pliers  
Pinces a fils  
Alicates para cortar alambre



Seitenschneider  
Lateral wire cutter  
Pince à couper le fil à tranchant latéral  
Alicates para cortar alambre con corte lateral

27.3457-23  
23,0 cm/9"

für harten Draht bis 2,2 mm  
for hard wire up to 2,2 mm  
pour fils durs jusqu'à 2,2 mm  
para hilos duros hasta 2,2 mm

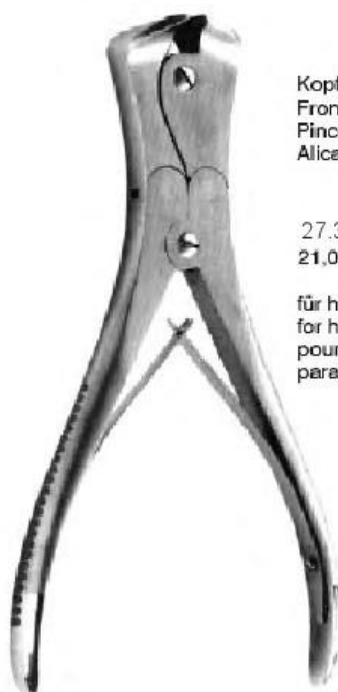

Kopfschneider  
Frontal wire cutting pliers  
Pince à couper le fil à tranchant frontal  
Alicates para cortar alambre con corte frontal

27.3458-21  
21,0 cm/8¼"

für harten Draht bis 2,5 mm  
for hard wire up to 2,5 mm  
pour fils durs jusqu'à 2,5 mm  
para hilos duros hasta 2,5 mm



Bolzenschneider  
Wire cutting pliers  
Pince à couper le fil  
Alicates para cortar alambre

27.3459-45	27.3459-56
45,0 cm/18"	56,0 cm/22½"

für Draht bis	6,0 mm	7,5 mm
for wire up to	6,0 mm	7,5 mm
pour fils jusqu'à	6,0 mm	7,5 mm
para hilos hasta	6,0 mm	7,5 mm

27.3459-90  
Ersatzbacken allein  
Cutting parts only  
Pièces coupantes seules

Scharfe loffel  
 Bone curettes  
 Curettes tranchantes  
 Cucharillas cortantes



**Volkmann**  
 17,0 cm/6 $\frac{3}{4}$ "

	Fig.	mm
27.3500	0000	3,0
27.3501	000	4,0
27.3502	00	5,0
27.3503	0	6,0
27.3504	1	7,0
27.3505	2	8,0
27.3506	3	10,0
27.3507	4	11,6
27.3508	5	12,6
27.3509	6	13,8

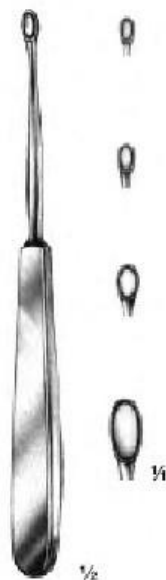

**Williger**  
 17,0 cm/6 $\frac{3}{4}$ "

	Fig.	mm
27.3538-20	00	2,0
27.3538-10	0	2,5
27.3538-01	1	3,5
27.3538-02	2	5,0

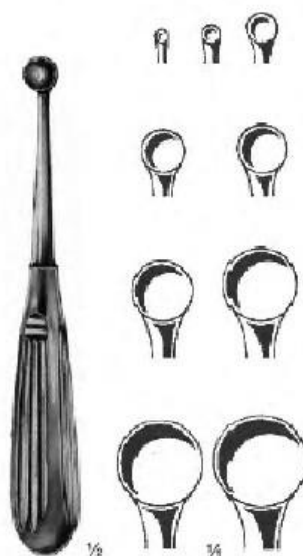

**Bruns**  
 17,0 cm/6 $\frac{3}{4}$ "

	Fig.	mm
27.3520	000	3,0
27.3521	00	4,0
27.3522	0	5,0
27.3523	1	6,0
27.3524	2	8,0
27.3525	3	10,0
27.3526	4	12,0
27.3527	5	13,0
27.3528	6	14,0

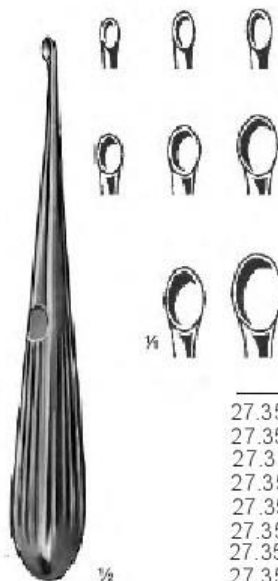

**Spratt**  
 17,0 cm/6 $\frac{3}{4}$ "

	Fig.	mm
27.3530	000	3,0
27.3531	00	4,0
27.3532	0	4,5
27.3533	1	5,0
27.3534	2	6,0
27.3535	3	7,0
27.3536	4	8,5
27.3537	5	9,5

Scharfe loffel  
Bone curettes  
Curettes tranchantes  
Cucharillas cortantes

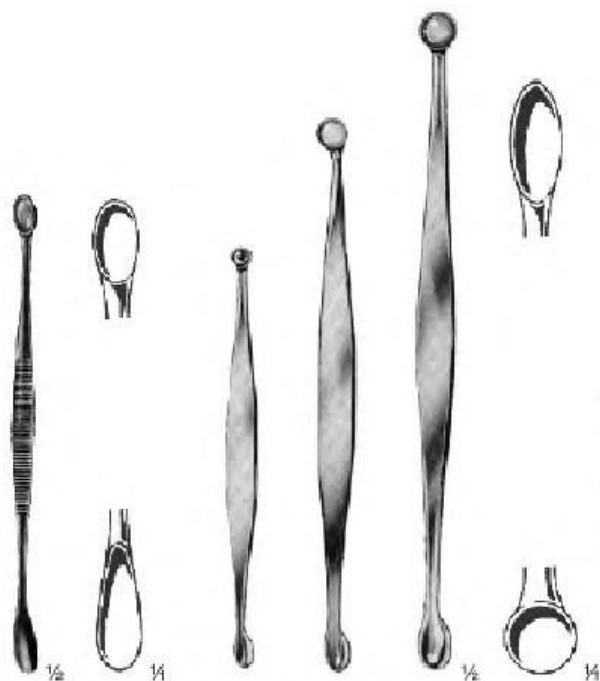

**Volkmann**

27.3550 - 27.3552

**Volkmann**

27.3555 - 27.3557

Länge Length Longueur Largo cm in.	oval/oval oval/oval ovale/ovale ovalada/ovalada	oval/rund oval/round ovale/ronde ovalada/redonda
13,0 5	27.3548 7,5/6,3mm	27.3548 6,3/6,8mm
14,5 5¾	27.3548 6,8/5,8mm	
16,0 6¼		27.3548 7,0/9,0mm
17,0 6¾	27.3548 6,8/7,3mm	
20,0 8		27.3548 9,1/11,1mm

7 mm



27.3558  
21,0 cm/8¼"



**Williger**  
13,5 cm/5¼"

	Fig.
27.3561	0/00
27.3562	0/1
27.3563	1/2

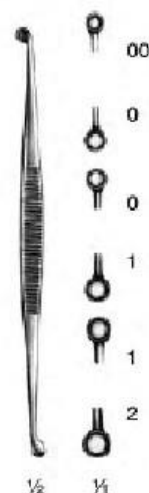

**Martini**  
13,5 cm/5¼"

	Fig.
27.3571	0/00
27.3572	0/1
27.3573	1/2

**Knochen hebel**  
**Bone levers**  
**Leviers a os**  
**Elevadores para huesos**

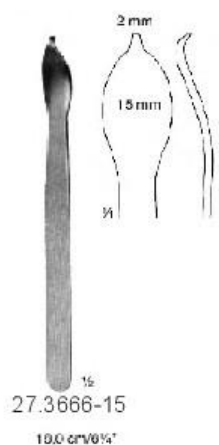
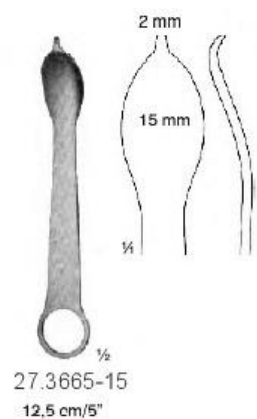
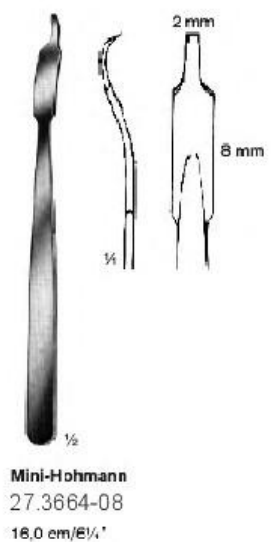
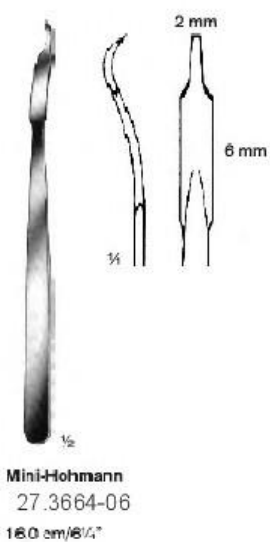
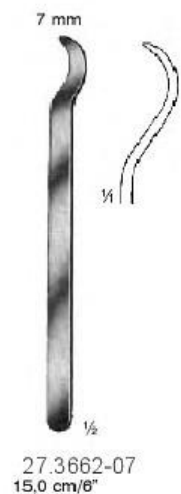
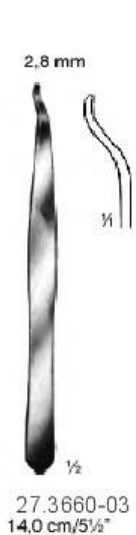

27.3667-08 08mm  
27.3667-10 10mm  
27.3666-17 17mm  
27.3666-18 18mm

Hammer  
Mallets  
Marteaux  
Martillos y mazos



26 mmØ  
340 g (12 oz.)

**Williger**

27.3680-28  
24,0 cm/9½"



27.3681-25  
25 mmØ  
120 g (4¼ oz.)

27.3681-30  
30 mmØ  
180 g (6½ oz.)

27.3681-35  
35 mmØ  
260 g (9 oz.)

**Doyen**  
21,0 cm/8¼"



30 mmØ  
220 g (7¾ oz.)

**Collin**

27.3682-30  
20,0 cm/8"



25 mmØ  
260 g (9 oz.)

**Lucae**

27.3683-25  
19,0 cm/7½"



30 mmØ  
240 g (8¾ oz.)

Stahl, massiv  
mit Leichtmetallgriff  
Steel solid  
with light metal handle  
Acier solide  
avec manche en métal léger  
Acero, macizo,  
con mango de metal ligero

**Cottle**

27.3688-30  
18,5 cm/7¼"



27 mmØ  
140 g (5 oz.)

**Hajek**

27.3689-27  
21,5 cm/8½"

Hammer  
Mallets  
Marteaux  
Martillos y mazos



30 mmØ  
300 g (10½ oz.)

**Bergmann**  
27.3690-30  
23,5 cm/9¼"



45 mmØ  
300 g (10½ oz.)

**Bergmann**  
27.3690-45  
24,5 cm/9¾"



40 mmØ  
550 g (19 oz.)

**Ombredanne**  
27.3691-4  
24,0 cm/9½"

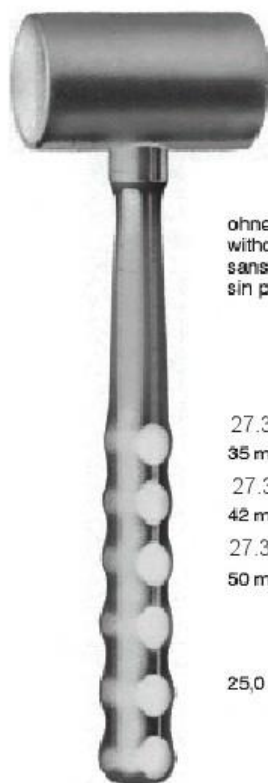

ohne Blei  
without lead  
sans plomb  
sin plomo

27.3692-35  
35 mmØ  
27.3692-42  
42 mmØ  
27.3692-50  
50 mmØ

25,0 cm/10"

42 mmØ



30 mmØ

400 g (14 oz.)

Stahl, massiv  
mit Leichtmetallgriff  
Steel solid  
with light metal handle  
Acier solide  
avec manche en métal léger  
Acero, macizo,  
con mango de metal ligero

24,0 cm/9½"

27.3693-42



27.3700-01  
gerade  
straight  
droite  
recta

Sequesterzangen  
Sequestum Forceps  
Pince à séquestre  
Pinza para secuestros



20,0 cm/8"



27.3700-02  
aufgebogen  
curved on flat  
courbe vers le haut  
curva sobre el plano

Knochen halte zangen  
Bone holding forceps  
Davier a os  
Pinzas para huesos



27.3701-14  
14,0 cm/5½"



Knorpelfaßzange  
Cartilage Seizing Forceps  
Pince à saisir cartilages  
Pinzas para coger cartilagos

Dingmann  
27.3702  
19,0 cm/7½"



27.3703  
12,0 cm/4¾"



Lewin  
27.3704-17  
17,5 cm/7"

Knochen halte zangen  
Bone holding forceps  
Davier a os  
Pinzas para huesos

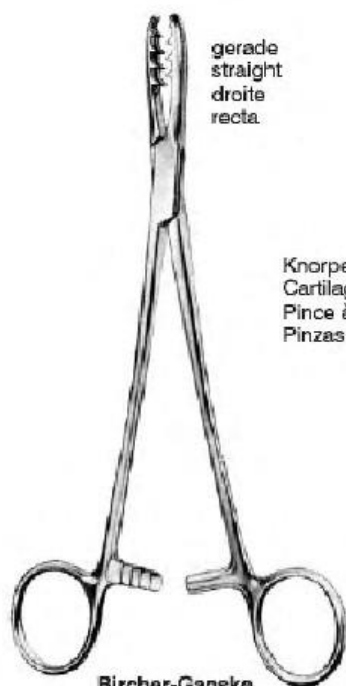

gerade  
straight  
droite  
recta

**Bircher-Ganske**

27.3705-01  
20,0cm

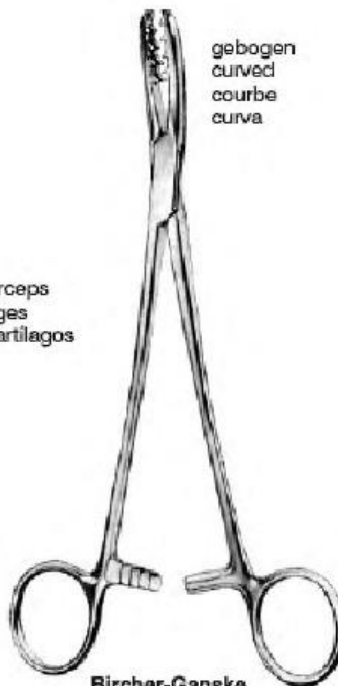

gebogen  
curved  
courbe  
curva

**Bircher-Ganske**

27.3705-02  
20,0cm

Knorpelfaßzangen  
Cartilage Seizing Forceps  
Pince à saisir cartilages  
Pinzas para coger cartilagos



**Setter**

27.3706-16  
16,0 cm/6¼"  
27.3706-24  
24,0 cm/9½"



**Semb**

27.3707  
19,0 cm/7½"  
ohne Sperre  
without ratchet  
sans crémaillère  
sin cremallera



**Semb**

27.3708  
19,0 cm/7½"  
mit Sperre  
with ratchet  
avec crémaillère  
con cremallera

Knochen halte zanger  
Bone holding forceps  
Davier a os  
Pinzas para huesos



**Fergusson**  
27.3713  
21,0 cm/8¼"

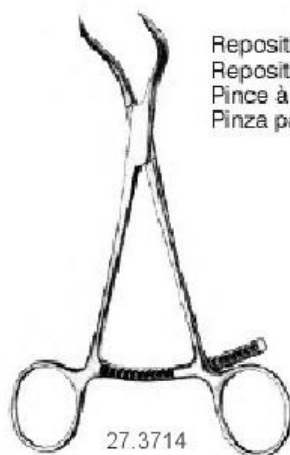

Repositionszange  
Reposition Forceps  
Pince à reduction  
Pinza para reposición

27.3714  
13,5 cm/5¼"



**Farabeuf-Lambotte**  
27.3715  
26,0 cm/10¼"  
mit Sperre  
with ratchet  
avec crémaillère  
con cremallera



27.3716-20  
20,0 cm/8"

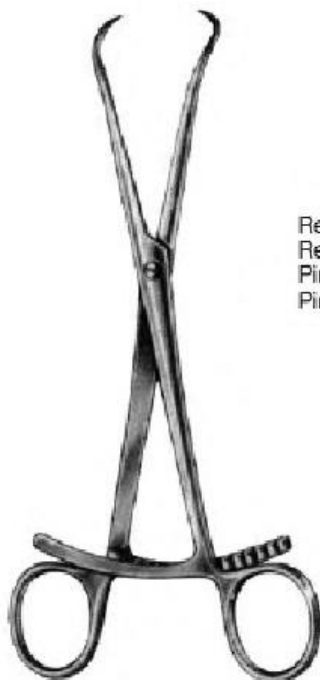

27.3717-01  
20,0 cm/8"

Repositionszangen  
Reposition Forceps  
Pince à reduction  
Pinza para reposición

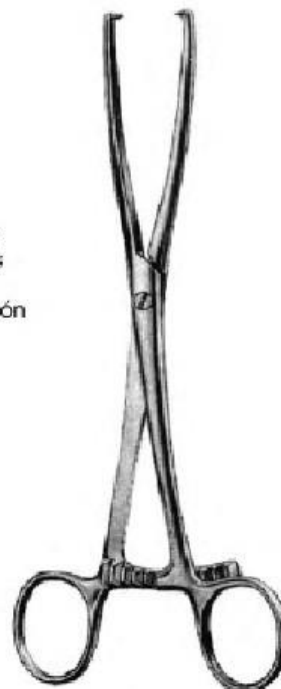

27.3717-02  
21,0 cm/8¼"

Knochen halte zangen  
Bone holding forceps  
Davier a os  
Pinzas para huesos

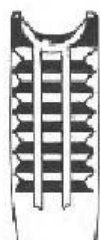

**Kern**

27.3718-17  
17,0 cm/6 3/4"

27.3720  
21,0 cm/8 1/4"

mit Sperre  
with ratchet  
avec crémaillère  
con cremallera

27.3719-17  
17,0 cm/6 3/4"

27.3721  
21,0 cm/8 1/4"

ohne Sperre  
without ratchet  
sans crémaillère  
sin cremallera



**Lane**

27.3722  
33,0 cm/13"

27.3724  
45,0 cm/17 3/4"

mit Sperre  
with ratchet  
avec crémaillère  
con cremallera

27.3723  
33,0 cm/13"

27.3725  
45,0 cm/17 3/4"

ohne Sperre  
without ratchet  
sans crémaillère  
sin cremallera



Knochen halte zangen  
Bone holding forceps  
Davier a os  
Pinzas para huesos



**Lambotte**

27.3727 22,0 cm/8 3/4"  
27.3728 26,0 cm/10 1/4"  
27.3729 33,0 cm/13"

gerade  
straight  
droite  
recta



**Lambotte**

27.3730 19,0 cm/7 1/2"  
27.3731 23,0 cm/9"  
27.3732 26,0 cm/10 1/4"

rechtswärts gebogen  
right angled  
courbe à droite  
curva a la derecha



**Lambotte**

27.3733 22,0 cm/8 3/4"  
27.3734 27,0 cm/10 3/4"  
27.3735 30,0 cm/11 3/4"

verstellbar  
adjustable  
ajustable  
ajustable



Verbrugge

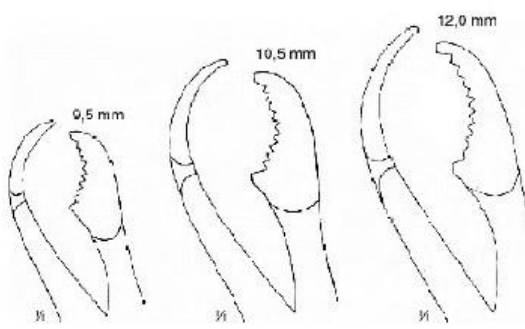

Fig. 1 25,0 cm/10"  
Fig. 2 26,0 cm/10 1/4"  
Fig. 3 27,0 cm/10 3/4"

27.3736

27.3737

27.3738



**Verbrugge**



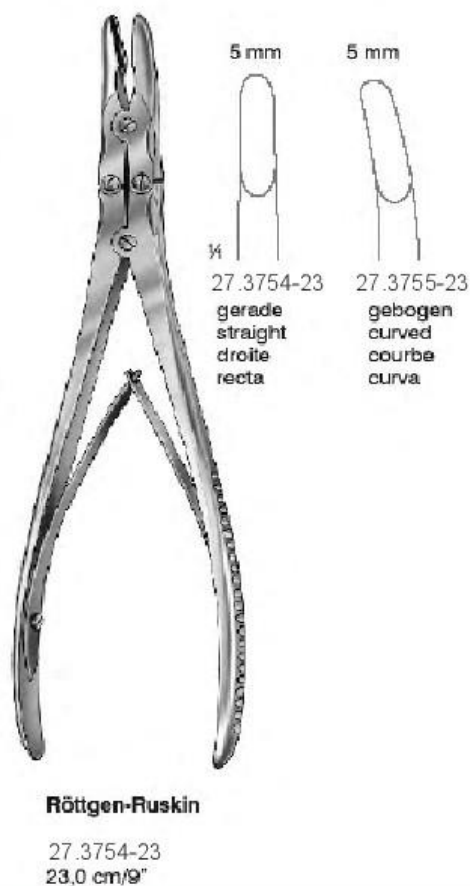
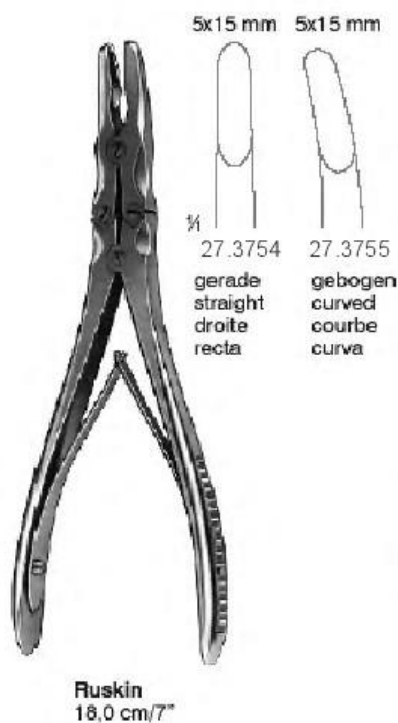
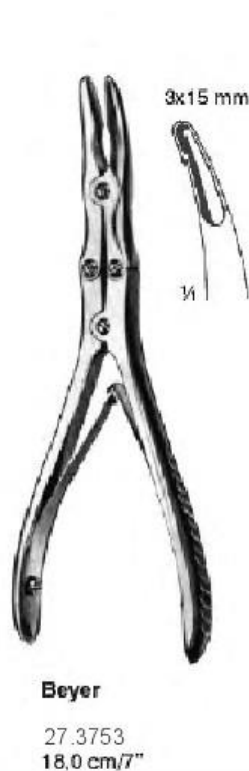
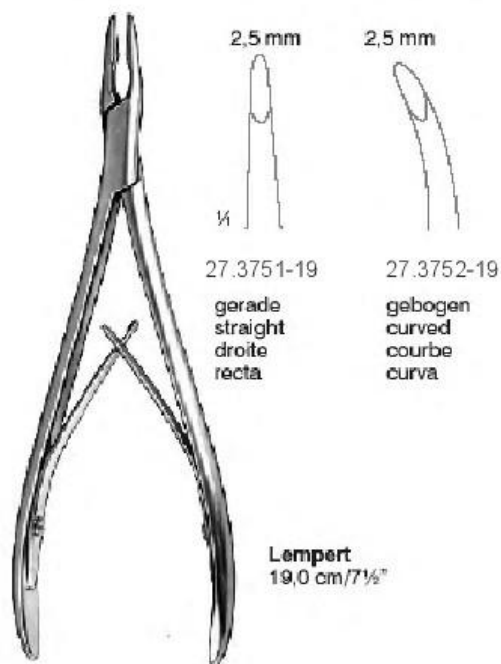
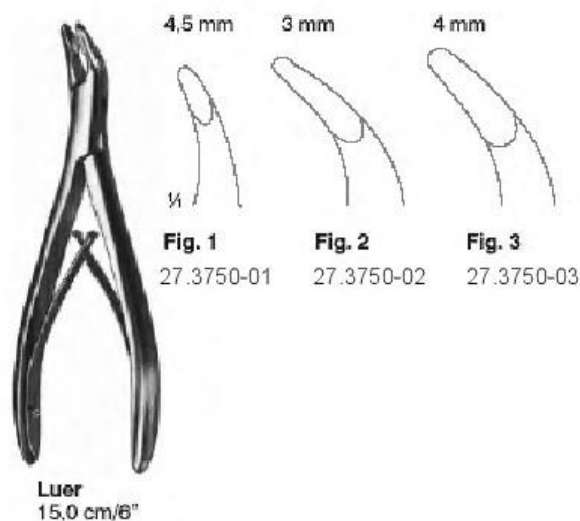

Fig. 0 27.3740 15,0 cm/6" 2,5 mm  
Fig. 1 27.3741 19,0 cm/7 1/2" 6,5 mm  
Fig. 2 27.3742 24,0 cm/9 1/2" 6,5 mm  
Fig. 3 27.3743 29,0 cm/11 3/4" 10,0 mm  
Fig. 4 27.3744 28,0 cm/11" 11,0 mm

Hohl meißel zangen  
Bone rongeur forceps  
Pincas-gouges  
Pinzas-gubias





Hohl meißel zangen  
Bone rongeur forceps  
Pincas-gouges  
Pinzas-gubias



	10 mm	10 mm	17 mm	17 mm
				
	27.3756 22,0 cm/8 <sup>3</sup> / <sub>4</sub> "	27.3757 22,0 cm/8 <sup>3</sup> / <sub>4</sub> "	27.3756-27 27,0 cm/10 <sup>3</sup> / <sub>4</sub> "	27.3757-27 27,0 cm/10 <sup>3</sup> / <sub>4</sub> "
	gerade straight droite recta	gebogen curved courbe curva	gerade straight droite recta	gebogen curved courbe curva

**Stille-Luer**

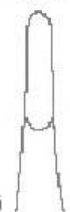

	4 mm	8 mm
		
	27.3758-04	27.3758-08

**Leksell-Stille**

24,0 cm/9<sup>1</sup>/<sub>2</sub>"

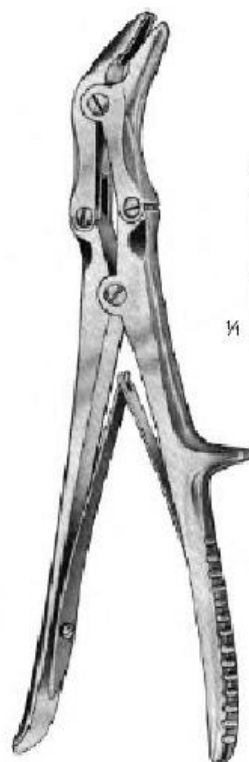

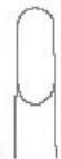
	7 mm
	

**Stille**

27.3758-23  
23,0 cm/9"

Hohl meißel zangen  
Bone rongeur forceps  
Pincas-gouges  
Pinzas-gubias



**Luer**  
17,0 cm/6¾"



27.3759

gerade  
straight  
droite  
recta



27.3760

gebogen  
curved  
courbe  
curva



**Luer-Friedmann**

27.3761  
14,0 cm/5½"

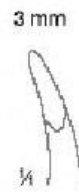

**Micro-Friedmann**

27.3761-02  
14,0 cm/5½"



**Mini-Friedmann**

27.3761-03  
12,0 cm/5"



**Cleveland**

27.3762  
14,0 cm/5½"

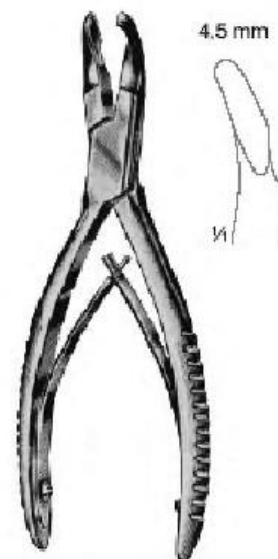

**Cleveland**

27.3763  
17,0 cm/6¾"



Hohl meißel zangen  
Bone rongeur forceps  
Pincès-gouges  
Pinzas-gubias



**Adson**  
27.3774  
20,0 cm/8"

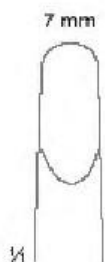

**Böhler**  
15,0 cm/6"

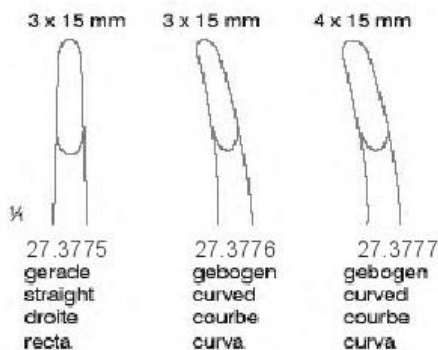

**Zaufal-Jansen**  
27.3778  
18,0cm

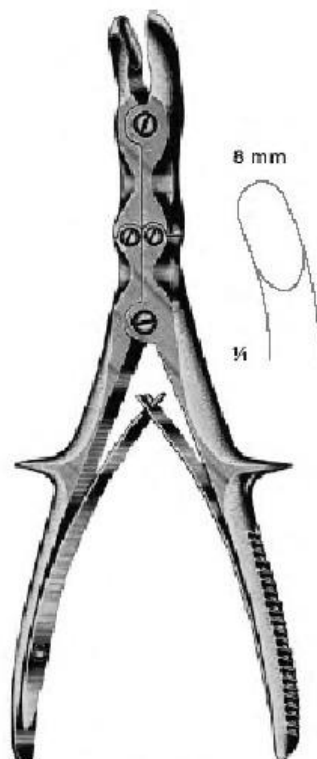

**Stille-Ruskin**  
27.3779  
23,0cm

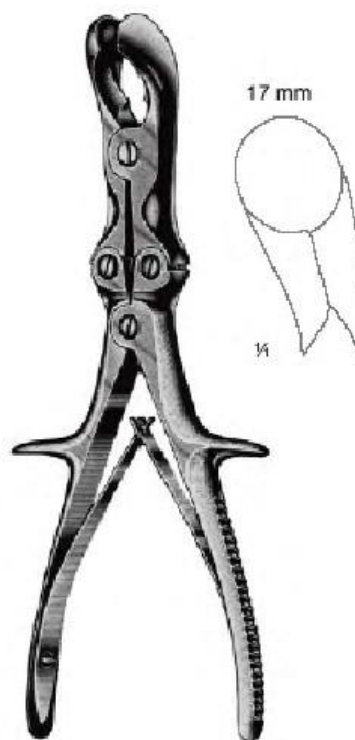

**Semb**  
27.3780  
22,5cm

Hohl meißel zangen  
Bone rongeur forceps  
Pincas-gouges  
Pinzas-gubias

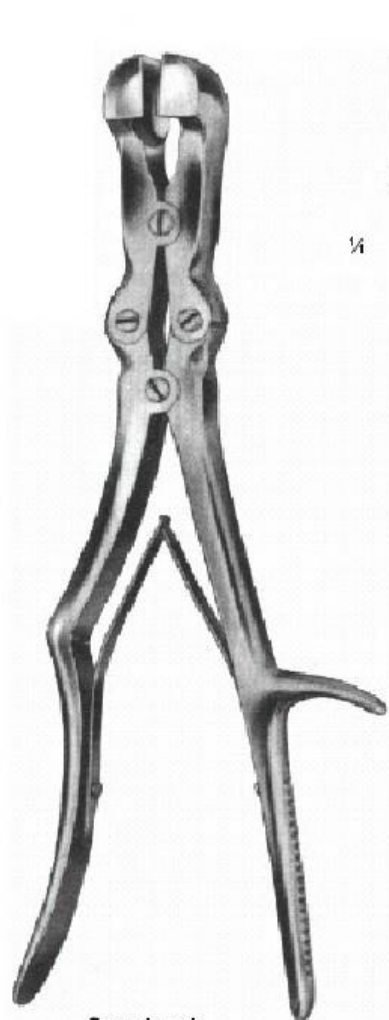

**Sauerbruch**  
30,0 cm/11¾"



27.3790



27.3791

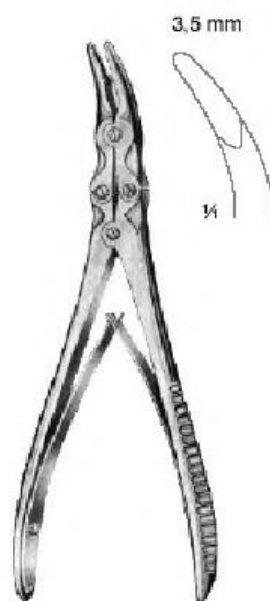

**Mayfield**

27.3792  
17,0 cm/6¾"

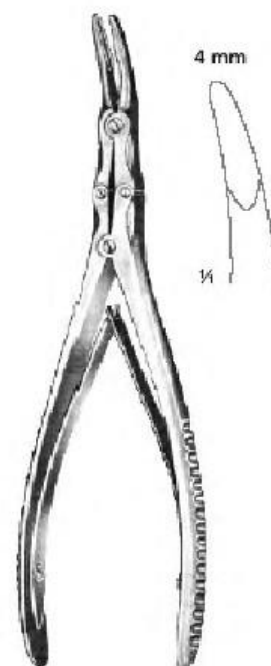

**Marquardt**

27.3793  
20,0 cm/8"

Knochen splitter zangen  
Bone cutting forceps  
Pincès coupantes a os  
Pinzas cortantes para huesos



gerade  
straight  
droite  
recta

27.3814	14,0 cm/5½"
27.3817	17,0 cm/6¾"
27.3819	19,0 cm/7½"
27.3822	22,0 cm/8¾"

Liston



gebogen  
curved  
courbe  
curva

27.3824	27.3827
27.3829	27.3832



gerade  
straight  
droite  
recta

gebogen  
curved  
courbe  
curva

Liston-Mini  
15,0 cm/6"



gerade  
straight  
droite  
recta

Stille-Liston

27.3840  
27,0 cm/10½"



gebogen  
curved  
courbe  
curva



Liston-Key

27.3842  
27,0 cm/10½"

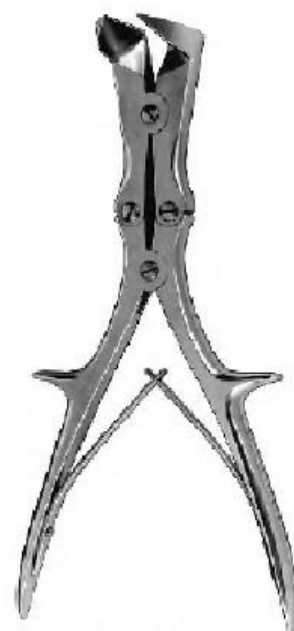

Stille-Liston

27.3843  
27,0 cm/10½"

Knochen splitter zangen  
Bone cutting forceps  
Pinces coupantes a os  
Pinzas cortantes para huesos



27.3844  
15,0 cm/6"



27.3845  
17,0 cm/6¾"

**Cleveland**  
gebogen  
curved  
courbe  
curva



27.3846  
gerade  
straight  
droite  
recta

**Böhler**  
15,0 cm/6"



27.3847  
nach vorn gebogen  
curved forward  
courbe en avant  
curva hacia delante



27.3848  
nach hinten gebogen  
curved backward  
courbe en arrière  
curva hacia atrás



27.3849  
gebogen  
curved  
courbe  
curva

**Mc Indoe**  
17,0 cm/6¾"

Knochen splitter zangen  
Bone cutting forceps  
Pinces coupantes a os  
Pinzas cortantes para huesos



**Ruskin**  
18,0 cm/7"



27.3850  
gerade  
straight  
droite  
recta



27.3851  
gebogen  
curved  
courbe  
curva



**Ruskin-Liston**  
18,0 cm/7"



27.3852  
gerade  
straight  
droite  
recta



27.3853  
gebogen  
curved  
courbe  
curva



**Semb**

27.3854  
23,0 cm/9"

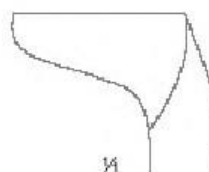

seitwärts gebogen  
sideways curved  
courbe sur le côté  
curva al lado

**Herz-, Thorax- und Gefäß-Chirurgie**  
**Cardiovascular and Thoracic Surgery**  
**Chirurgie cardiovasculaire et Thoracoplastie**  
**Cirugía cardiovascular y Toracoplástica**

Knochen- und rippen scheren  
Bone and rib shears  
Costotomes, cisailles pour os  
Cizallas para huesos y costillas

mit ziehendem Schnitt  
with eccentric sliding blade  
avec lame glissante  
con hoja de retroacción



28.3859  
22,0 cm/8<sup>3</sup>/<sub>4</sub>"

Rippenschere  
Rib Shears  
Costotomes  
Cizallas para costillas



28.3860-19 19,5 cm/7<sup>3</sup>/<sub>4</sub>"  
28.3860-23 22,5 cm/9"

Knochenschere  
Bone Shears  
Cisailles pour os  
Cizallas para huesos



**Gluck**  
28.3861  
21,0 cm/8<sup>3</sup>/<sub>4</sub>"

Rippenschere  
Rib Shears  
Costotomes  
Cizallas para costillas

Lungenfaß zangen  
Lung grasping forceps  
Pincas-clamps a poumons  
Pinzas clamps pulmonares

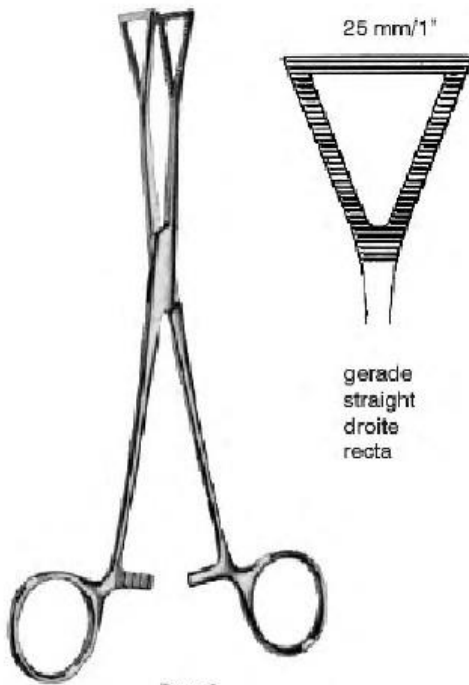

25 mm/1"

gerade  
straight  
droite  
recta

**Duval**

28.4052    28.4054  
20,0 cm/8"    23,0 cm/9 1/4"

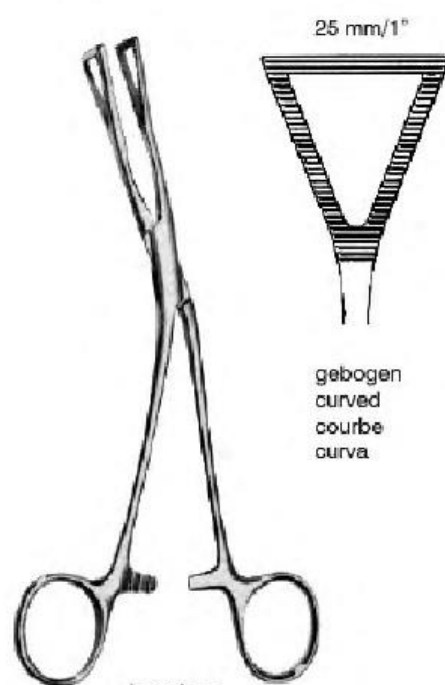

25 mm/1"

gebogen  
curved  
courbe  
curva

**Lovelace**

28.4053  
20,0 cm/8"



**Collin**

13 mm/1/2"



28.4057  
20,0 cm/8"

25 mm/1"



28.4058  
20,0 cm/8"

28.4059  
23,0 cm/9 1/4"

Bronchus klemmen  
Brochus clamps  
Pinces-clamps a brochies  
Pinzas-clamps para bronquios

Gafab klemmen  
Blood vessel clamps  
Pinces vasculaires  
Clamps para vasos



28.4061-01

28.4061-02

Bronchusklemmen  
Bronchus Clamps  
Pinces-clamps à bronches  
Pinzas-clamps para bronquios

Bronchusklemmen  
Bronchus Clamps  
Pinces-clamps à bronches  
Pinzas-clamps para bronquios



**Price-Thomas**

28.4060  
22,5 cm/9"



**Price-Thomas**  
22,5 cm/9"

Gefäßklemmen  
Blood Vessel Clamps  
Pinces vasculaires  
Clamps para vasos

s-förmig  
s-shaped  
forme en S  
en forma de S



**Satinsky**  
26,5cm

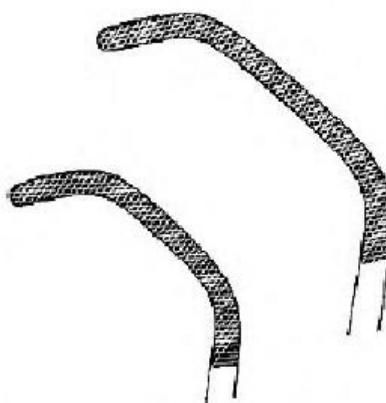

**Fig. 1**  
28.4064

**Fig. 2**  
28.4065

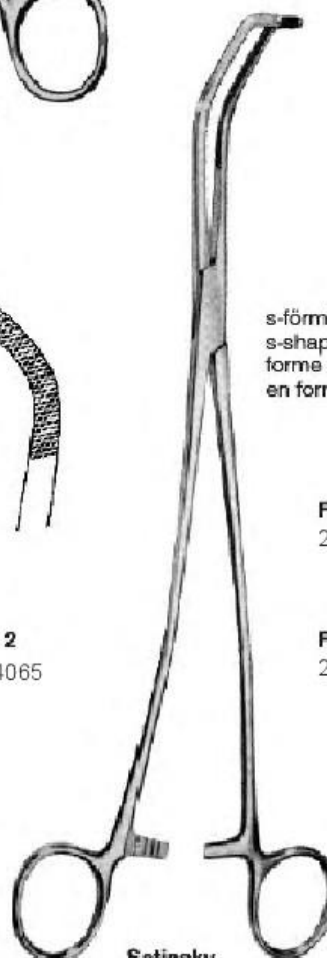

**Satinsky**  
26,5cm

**Fig. 1**  
28.4066

**Fig. 2**  
28.4067

Gafab klemmen      Gafab dilatatoren  
Blood vessel clamps    Vascular dilators  
Pincès vasculaires    Dilatateurs vasculaires  
Clamps para vasos    Dilatadores vasculares

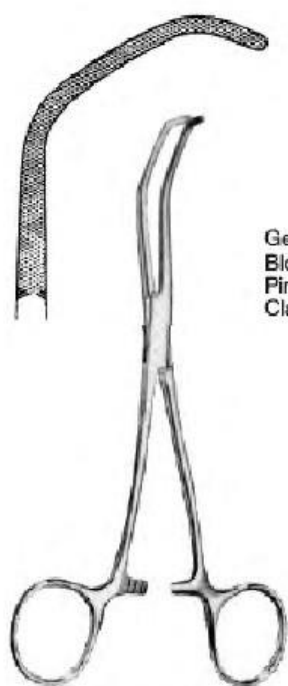

**Baby-Satinsky**

28.4068  
15,0 cm/6"

Gefäßklemmen  
Blood Vessel Clamps  
Pincès vasculaires  
Clamps para vasos

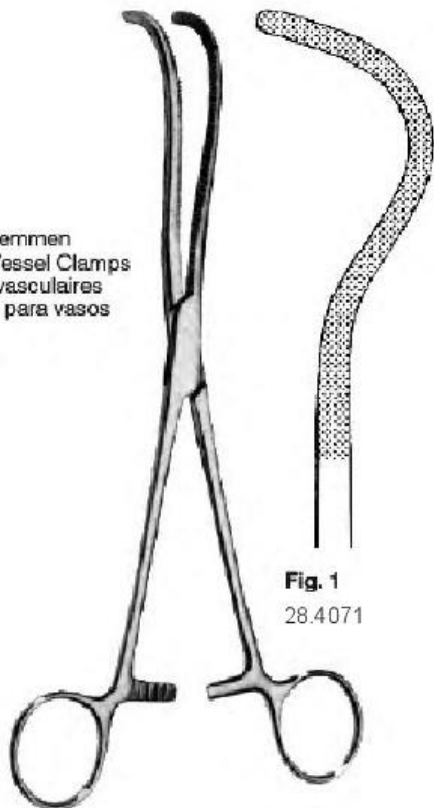

**Fig. 1**  
28.4071

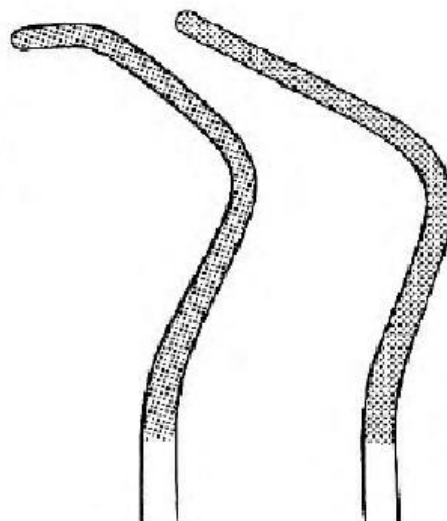

**Fig. 2**  
28.4072

**Fig. 3**  
28.4073

**Harken**  
24,0 cm/9½"

Gefäßdilatoren  
Vascular Dilators  
Dilatateurs vasculaires  
Dilatadores vasculares

biegsam  
malleable  
flexible



19,0 cm/7½"



28.4080-05  
0,5 mmØ



28.4080-10  
1,0 mmØ



28.4080-15  
1,5 mmØ



28.4080-20  
2,0 mmØ



28.4080-25  
2,5 mmØ



28.4080-30  
3,0 mmØ



28.4080-35  
3,5 mmØ



28.4080-40  
4,0 mmØ



28.4080-45  
4,5 mmØ



28.4080-50  
5,0 mmØ



28.4080-70  
7,0 mmØ



28.4080-90  
9,0 mmØ

**Tracheotomie**  
**Tracheotomy**  
**Trachéotomie**  
**Traqueotomía**

Tracheal-dilatatoren  
Trachea dilators  
Dilatateurs pour la trachéotomie  
Dilatadores para la tráquea

Tracheal-häkehen  
Trachea retractors  
Crochets pour la trachéotomie  
Ganchos para la tráquea

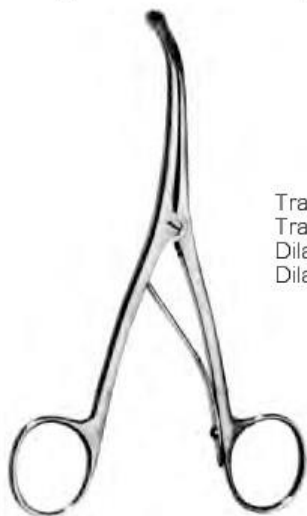

**Trousseau**

29.4100  
14,0 cm/5½"

Tracheal-Dilatatoren  
Trachea Dilators  
Dilatateurs pour la trachéotomie  
Dilatadores para la tráquea

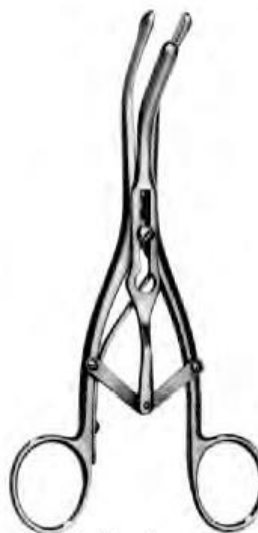

**Laborde**

29.4101  
14,0 cm/5½"

Tracheal-Häkchen, Trachea Retractors, Crochets pour la trachéotomie, Ganchos para la tráquea



links  
left  
gauche  
izquierda

**Bose**

29.4110-01  
16,0 cm/6¼"



rechts  
right  
droit  
derecha

**Bose**

29.4110-02  
16,0 cm/6¼"



spitz  
sharp  
pointu  
agudo

**Iterson**

29.4112-01  
16,0 cm/6¼"



stumpf  
blunt  
mousse  
romo

**Iterson**

29.4112-02  
16,0 cm/6¼"

Tracheal-häkehen  
Trachea retractors  
Crochets pour la trachéotomie  
Ganchos para la tráquea

Schilddrüsen haken  
Thyroid gland retractor  
Ecarteux pour la thyroïde  
Separador para la glándula tiroidea



**Jackson**

29.4113  
15,0 cm/6"

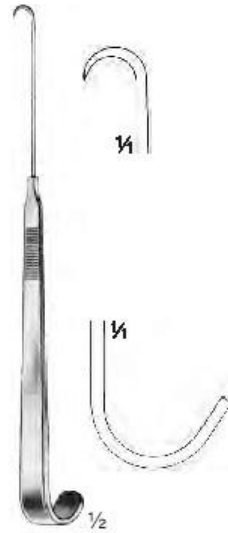

**News**

29.4114  
15,0 cm/6"



**Rose**

29.4115  
13,5 cm/5"

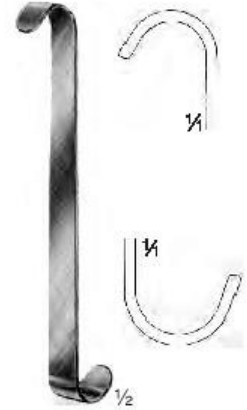

**Luer**

29.4116  
11,0 cm/4½"



**Lukens**

29.4117  
17,0 cm/6¾"



**Jackson**

29.4118  
17,0 cm/6¾"



**Schoenborn**

29.4119  
21,0 cm/8¼"



**Lahey**

29.4150-15  
15,0 cm/6"

29.4150-20  
20,0 cm/8"

Laryngoskope  
Laryngoscopes  
Laryngoscopes  
Laringoscopios

**Narkose**  
**Anaesthesia**  
**Anesthésie**  
**Anestesia**



**McIntosh**

30.4200

Laryngoskopie-Besteck, bestehend aus:  
Laryngoscope set, consisting of:  
Trousse à laryngoscopie, composée de:  
Set de laryngoscopia, compuesto de:

Etui, case, boîte, estuche (30.4205-03)  
Griff, handle, manche, mango (30.4225-01)  
Spatel, blades, spatules, hojas  
Fig. 1 (30.4203-01)  
Fig. 2 (30.4203-02)  
Fig. 3 (30.4203-03)



**McIntosh**

30.4202

Laryngoskopie-Besteck, bestehend aus:  
Laryngoscope set, consisting of:  
Trousse à laryngoscopie, composée de:  
Set de laryngoscopia, compuesto de:

Etui, case, boîte, estuche (30.4205-04)  
Griff, handle, manche, mango (30.4225-01)  
Spatel, blades, spatules, hojas  
Fig. 1 (30.4203-01)  
Fig. 2 (30.4203-02)  
Fig. 3 (30.4203-03)  
Fig. 4 (30.4203-04)

Laryngoskope  
Laryngoscopes  
Laryngoscopes  
Laringoscopios

**Miller**

30.4210  
Laryngoskopie-Besteck, bestehend aus:  
Laryngoscope set, consisting of:  
Trousse à laryngoscopie, composée de:  
Set de laryngoscopia, compuesto de:

Etui, case, boîte, estuche (30.4213)  
Griff, handle, manche, mango (30.4225-01)  
Spatel, blades, spatules, hojas  
Fig. 0 (30.4212-00)  
Fig. 1 (30.4212-01)  
Fig. 2 (30.4212-02)  
Fig. 3 (30.4212-03)  
Fig. 4 (30.4212-04)

30.4213  
Etui allein, passend für Miller Spatel und Griff  
Case only, for Miller blades and handle  
Boîte seule, pour Miller spatules et manche  
Estuche, para Miller hojas y mango  
Fig. 0 (30.4212-00)  
Fig. 1 (30.4212-01)  
Fig. 2 (30.4212-02)  
Fig. 3 (30.4212-03)  
Fig. 4 (30.4212-04)



30.4225-01

Griff  
Handle  
Manche  
Mango



30.4227-01

Ersatzbirne klein, 2,5 V  
Spare bulb small, 2,5 V  
Lampe de rechange petite, 2,5 V  
Bombilla de repuesto pequeña, 2,5 V



30.4227-02

Ersatzbirne groß, 2,5 V  
Spare bulb large, 2,5 V  
Lampe de rechange grande, 2,5 V  
Bombilla de repuesto grande, 2,5 V

**Miller**



Fig. 0  
30.4212-00



Fig. 1  
30.4212-01

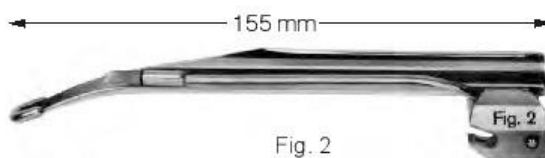

Fig. 2  
30.4212-02



Fig. 3  
30.4212-03



Fig. 4  
30.4212-04

Laryngoskope, Kaltlicht  
Laryngoscopes, Cold light  
Laryngoscopes, Lumière froide  
Laringoscopios, Luz fría

**McIntosh**

**McIntosh**

30.4240

Laryngoskopie-Besteck, bestehend aus:

Laryngoscope set, consisting of:

Trousse à laryngoscopie, composée de:

Set de laryngoscopia, compuesto de:

Etui, case, boîte, estuche (30.4205-03)

Griff, handle, manche, mango (30.4266-01)

Spatel, blades, spatules, hojas

Fig. 1 (30.4243-01)

Fig. 2 (30.4243-02)

Fig. 3 (30.4243-03)

30.4205-03

Etui allein, passend für McIntosh Spatel und Griff

Case only, for McIntosh blades and handle

Boîte seule, pour McIntosh spatules et manche

Estuche, para McIntosh hojas y mango

Fig. 1 (30.4243-01)

Fig. 2 (30.4243-02)

Fig. 3 (30.4243-03)

30.4205-04

Etui allein, passend für McIntosh Spatel und Griff

Case only, for McIntosh blades and handle

Boîte seule, pour McIntosh spatules et manche

Estuche, para McIntosh hojas y mango

Fig. 1 (30.4243-01)

Fig. 2 (30.4243-02)

Fig. 3 (30.4243-03)

Fig. 4 (30.4243-04)

75 mm



90 mm



110 mm



130 mm



150 mm



Laryngoskope, Kaltlicht  
Laryngoscopes, Cold light  
Laryngoscopes, Lumiere froide  
Laringoscopios, Luz fría



**Miller**

30.4250

Laryngoskopie-Besteck, bestehend aus:  
Laryngoscope set, consisting of:

Trousse à laryngoscopie, composée de:  
Set de laryngoscopia, compuesto de:

Etui, case, boîte, estuche (30.4213)

Griff, handle, manche, mango (30.4266-01)

Spatel, blades, spatules, hojas

Fig. 0 (30.4253-00)

Fig. 1 (30.4253-01)

Fig. 2 (30.4253-02)

Fig. 3 (30.4253-03)

Fig. 4 (30.4253-04)

Darm-und gewebe fang zangen  
Intestinal and tissue grasping forceps  
Pinces pour saisir l'intestin et le tissu  
Pinzas para cajar intestinas y tejidos



4:5

31.4300  
15,0 cm/6"

5:6

31.4302 15,0 cm/6"  
31.4303 19,0 cm/7½"  
31.4304 25,0 cm/10"  
31.4313 22,0 cm/8¾"

3:4

31.4308  
15,0 cm/6"

Allis

Magen und Darm  
Stomach, Intestine  
Estomac, Intestin  
Estómago, Intestino



4:5

4:5

Allis-Baby

31.4301-13 13,0 cm/5"  
31.4301-14 14,0 cm/5½"

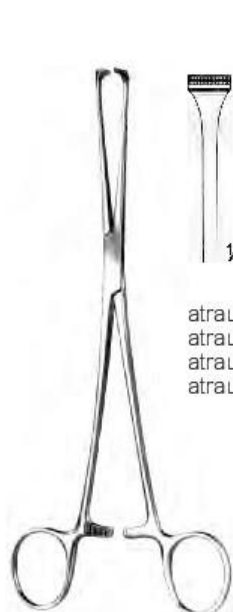

atraumatisch  
atraumatic  
atraumatique  
atraumática

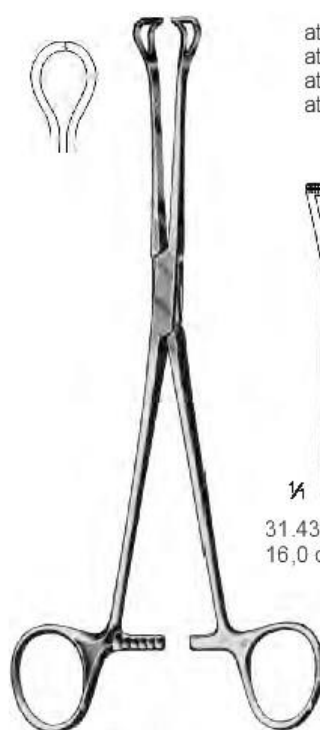

atraumatisch  
atraumatic  
atraumatique  
atraumática

31.4324-16  
16,0 cm/6¼"

31.4324-21  
21,0 cm/8¼"

Babcock

Darm faszange  
Intestinal Forceps  
Pinces pour saisir l'intestin  
Pinzas para coger intestinos

**Galle, Niere, Urologie**  
**Bile, Kidney, Urology**  
**Bile, Rein, Urologie**  
**Vesícula biliar, Riñon, Urología**

Nieren stein zangen  
Kidney stone forceps  
Pinces pour les calculs de bassinnet  
Pinzas para cálculos renales



Fig. 1

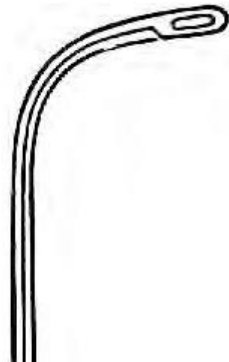

Fig. 2

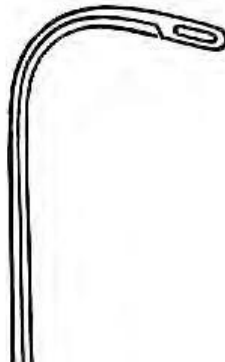

Fig. 3

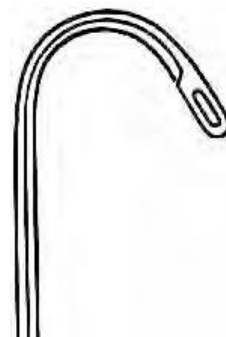

Fig. 4



**Randall**

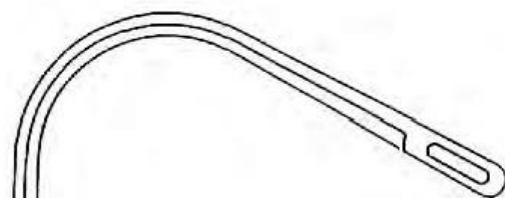

Fig. 5

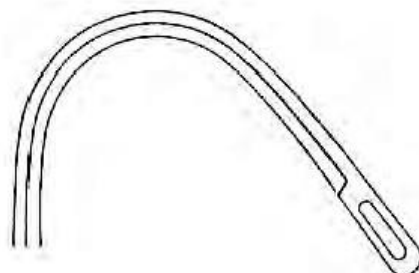

Fig. 6

Fig. 1	32.4450	23,0 cm/9"
Fig. 2	32.4451	22,0 cm/8¾"
Fig. 3	32.4452	22,0 cm/8¾"
Fig. 4	32.4453	22,0 cm/8¾"
Fig. 5	32.4454	19,0 cm/7½"
Fig. 6	32.4455	19,0 cm/7½"

Gallen stein zangen  
Gall stone forceps  
Pincés pour les calculs biliaires  
Pinzas para cálculos biliares



**Desjardins**  
23,0 cm/9"



Fig. 1  
32.4460



Fig. 2  
32.4461



**Blake**  
20,0 cm/8"



32.4462

gerade  
straight  
droite  
recta



32.4463

gebogen  
curved  
courbe  
curva

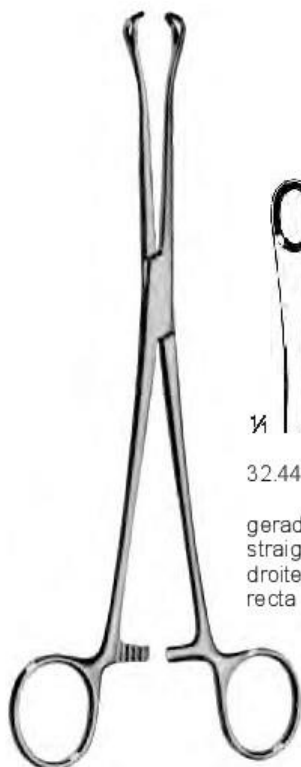

**Mayo-Blake**  
20,0 cm/8"



32.4464

gerade  
straight  
droite  
recta



32.4465

gebogen  
curved  
courbe  
curva



**Mixer**

32.4466  
22,0 cm/8¾"

Blasen spatel  
Bladder retractors  
Spatules vésicales  
Separadores vesicales



35 mm

**Legue**

32.4620  
27,0 cm/10½"



56 mm

**Kocher**

32.4621  
26,0 cm/10¼"



67 mm

**Kocher**

32.4622  
26,0 cm/10¼"

Fremdkörperzangen  
Foreign Body Forceps  
Pincès à corps étrangers  
Pinzas para cuerpos extraños

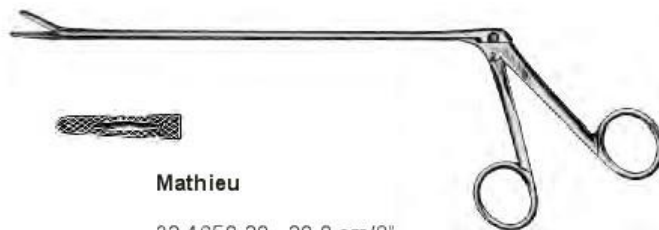

**Mathieu**

32.4650-20 20,0 cm/8"  
32.4650-28 28,0 cm/11"

**Gynäkologie, Geburtshilfe**  
**Gynecology, Obstetrics**  
**Gynécologie, Accouchement**  
**Ginecología, Obstetricia**

**Scheiden spekula**  
**Vaginal specula**  
**Speculums vaginaux**  
**Especulos vaginales**



**Cusco**  
Fig.1 33.4800 85 x 17 mm

für Jungfrauen  
for virgins  
pour vierges  
para vírgenes



**Cusco**  
Fig.1 33.4801 75 x 32 mm  
Fig.2 33.4802 85 x 35 mm  
Fig.3 33.4803 100 x 35 mm



**Cusco**  
Fig.1 33.4805 90 x 23/25 mm  
Fig.2 33.4806 100 x 25/27 mm  
Fig.3 33.4807 110 x 27/30 mm

Schweizer Modell  
Swiss pattern  
Modèle suisse  
Modelo suizo



**Grave**  
Fig.1 33.4811 85 x 33 mm  
Fig.2 33.4812 95 x 33 mm  
Fig.3 33.4813 105 x 33 mm



**Collin**  
Fig.1 33.4821 90 x 29 mm  
Fig.2 33.4822 95 x 32 mm  
Fig.3 33.4823 110 x 40 mm



**Pederson**  
Fig.1 33.4824 75 x 13 mm  
Fig.2 33.4825 100 x 22 mm  
Fig.3 33.4826 120 x 25 mm

Scheiden spekula  
Vaginal specula  
Speculums vaginaux  
Especulos vaginales



**Semm**

Fig.1	33.4827	95 x 14/18 mm
Fig.2	33.4828	100 x 20/25 mm
Fig.3	33.4829	105 x 27/35 mm

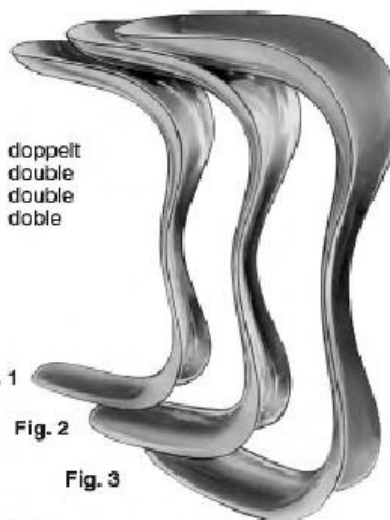

doppelt  
double  
double  
double

Fig. 1

Fig. 2

Fig. 3

**Sims**

Fig.1	33.4831	25 x 30 mm
Fig.2	33.4832	30 x 35 mm
Fig.3	33.4833	35 x 40 mm



29,0cm

Fig.1	33.4837-20	100 x 20 mm
Fig.2	33.4837-25	100 x 25 mm
Fig.3	33.4837-30	100 x 30 mm
Fig.4	33.4837-35	100 x 35 mm
Fig.5	33.4837-40	100 x 40 mm

32,0c

Fig.1	33.4838-20	130 x 20 mm
Fig.2	33.4838-25	130 x 25 mm
Fig.3	33.4838-30	130 x 30 mm
Fig.4	33.4838-35	130 x 35 mm
Fig.5	33.4838-40	130 x 40 mm

35,0 cm/13¾"  
33.4839 155 x 30 mm

**Breisky**



**Doyen**  
33.4840 70 x 30 mm  
24,0 cm/9½"

Scheiden spekula  
Vaginal specula  
Speculums vaginaux  
Especulos vaginales



**Mathieu**  
21,0 cm/8 1/4"

Spekula  
Specula  
Spéculum  
Especulo

33.4840-01 95 x 17-30 mm

Halter  
Retractor  
Valve  
Valva

33.4840-02 95 x 17-26 mm

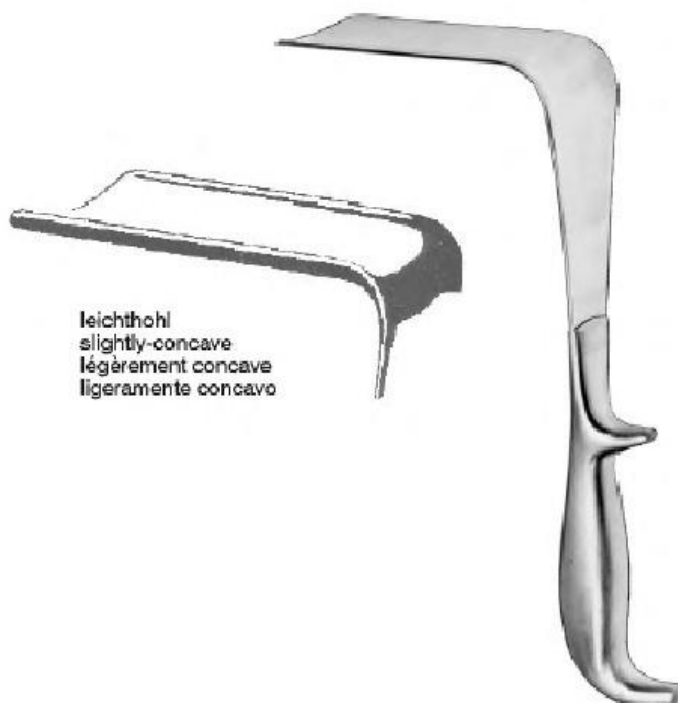

**Doyen**

Fig.1 33.4841 60 x 35 mm  
Fig.2 33.4842 90 x 35 mm  
Fig.3 33.4843 120 x 35 mm  
Fig.4 33.4844 160 x 35 mm

Fig.1 33.4851 60 x 45 mm  
Fig.2 33.4852 90 x 45 mm  
Fig.3 33.4853 120 x 45 mm  
Fig.4 33.4854 160 x 45 mm

Fig.1 33.4861 60 x 60 mm  
Fig.2 33.4862 90 x 60 mm  
Fig.3 33.4863 120 x 60 mm  
Fig.4 33.4864 160 x 60 mm

Uterus dilatatore  
 Uterine-dilators  
 Dilatateurs uterins  
 Dilatadores uterinos



	mm
33.4729-03	3
33.4729-04	4
33.4729-05	5
33.4729-06	6
33.4729-07	7
33.4729-08	8
33.4729-09	9
33.4729-10	10
33.4729-11	11
33.4729-12	12
33.4729-13	13
33.4729-14	14
33.4729-15	15
33.4729-16	16
33.4729-17	17
33.4729-18	18
33.4729-19	19
33.4729-20	20
33.4729-21	21
33.4729-22	22
33.4729-23	23
33.4729-24	24

**Hegar**  
 mit geriettem Griff und Rinne  
 with serrated handle and groove  
 avec manche strié et cannelure  
 con mango estriado y acanaladura



	mm		mm
33.4730	1	33.4760	1,5
33.4731	2	33.4761	2,5
33.4732	3	33.4762	3,5
33.4733	4	33.4763	4,5
33.4734	5	33.4764	5,5
33.4735	6	33.4765	6,5
33.4736	7	33.4766	7,5
33.4737	8	33.4767	8,5
33.4738	9	33.4768	9,5
33.4739	10	33.4769	10,5
33.4740	11	33.4770	11,5
33.4741	12	33.4771	12,5
33.4742	13	33.4772	13,5
33.4743	14	33.4773	14,5
33.4744	15	33.4774	15,5
33.4745	16	33.4775	16,5
33.4746	17	33.4776	17,5
33.4747	18	33.4777	18,5
33.4748	19	33.4778	19,5
33.4749	20	33.4779	20,5
33.4750	21	33.4780	21,5
33.4751	22	33.4781	22,5
33.4752	23	33.4782	23,5
33.4753	24		
33.4754	25		
33.4755	26		
33.4756	27		
33.4757	28		
33.4758	29		
33.4759	30		

**Hegar**  
 mit glattem Muldengriff  
 with sloped handle  
 avec manche aplati  
 con mango aplanado



**Hegar**  
 doppelt  
 double  
 double  
 doble

	mm
33.4784	1/2
33.4785	3/4
33.4786	5/6
33.4787	7/8
33.4788	9/10
33.4789	11/12
33.4790	13/14
33.4791	15/16
33.4792	17/18
33.4793	19/20
33.4794	21/22
33.4795	23/24
33.4796	25/26

Satz		Stück per Satz
Set		Pieces per set
Jeu		Pièces par jeu
Juego	mm	Piezas por juego
33.4908	3/4 - 17/18	8
33.4909	1/2 - 25/26	13

Uterus dilatatore[n]  
Uterine dilators  
Dilatateurs utérins  
Dilatadores uterinos

Uterus sonden  
Uterine sounds  
Hystéromètres  
Histerometros

Uterus-depressoren  
Uterine depressors  
Depresseurs utérins  
Depresores uterinos

Uterusdilatatoren  
Uterine Dilators  
Dilatateurs utérins  
Dilatadores uterinos

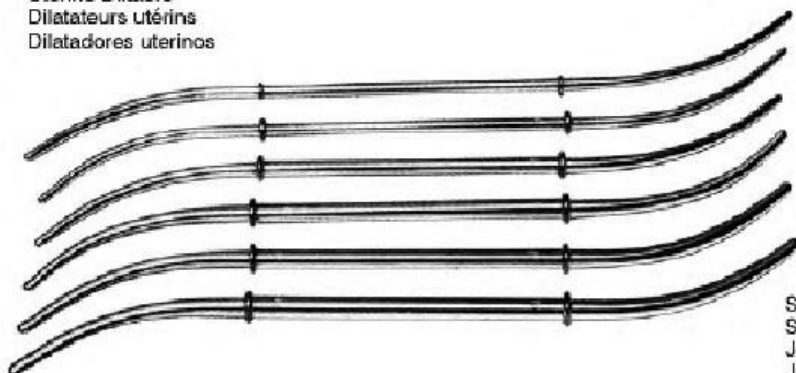

Amerikanische Skala  
American scale  
Echelle américaine  
Escala americana

Hank		mm
Fig. 9/10	33.4913-09	4,5/5
Fig. 11/12	33.4913-11	5,5/6
Fig. 13/14	33.4913-13	6,5/7
Fig. 15/16	33.4913-15	7,5/8
Fig. 17/18	33.4913-17	8,5/9
Fig. 19/20	33.4913-19	9,5/10

Satz Set Jeu Juego	mm	Stück per Satz Pieces per set Pièces par jeu Piezas por juego
33.4913-00	9/10 - 19/20	6

33.4913-00 9/10 - 19/20 6

Uterussonden  
Uterine Sounds  
Hystéromètres  
Histerómetros



**Sims**  
32 cm/12½"

33.4920  
starr, graduert in cm  
rigid, graduated in cm  
rigide, gradué en cm  
rígido, graduado en cm

33.4921  
biegsam, graduert in cm  
malleable, graduated in cm  
malléable, gradué en cm  
maleable, graduado en cm



biegsam  
malleable  
malléable  
maleable

**Martin**  
33.4923  
32 cm/12½"



Uterus-Depressor  
Uterine depressor  
Depresseur utérin  
Depresor uterino

**Braun**  
33.4924  
27,5 cm/11"

Haken zangen  
Tenaculum forceps  
Pincas a griffes  
Pinzas para coger el cuello del utero



S-förmig  
S-shaped  
forme en S  
en forma de S

**Duplay**  
33.4949  
25,0 cm/10"

Uterus-Polypenzangen  
Uterine Polypus Forceps  
Pincas a polypes utérins  
Pinzas para polpos uterinos



**Schröder-Braun**  
25,0 cm/10"  
33.4950



**Braun**  
33.4951  
25,0 cm



**Skene**  
33.4953  
24,0 cm



**Kelly**  
33.4990  
32,0 cm/12½"

Ovarien-Faßzange  
Ovarian Elevating Forceps  
Pincas pour les ovaires  
Pinzas para ovarios



**Doyen**  
33.4995  
20,0 cm

Biopsie zangen  
Biopsy punches  
Pincas emporte-pieces a biopsie  
Pinzas para biopsia

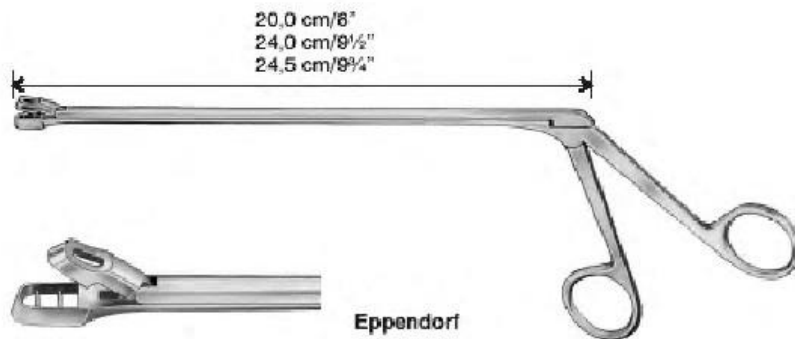

4,5 x 8 mm

**Eppendorf**

33.5040  
20,0 cm/8"



**Wittner**

33.5041  
20,0 cm/8"  
gebogen, curved  
courbe, curva

**Wittner**

33.5042  
20,0 cm/8"  
gerade, straight  
droite, recta

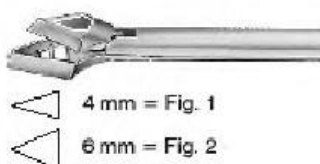

**Schumacher**

Fig. 1  
33.5043  
24,0 cm/9 1/2"

**Schumacher**

Fig. 2  
33.5044  
24,0 cm/9 1/2"



**Kevorkian**

33.5049  
24,5 cm/9 1/2"

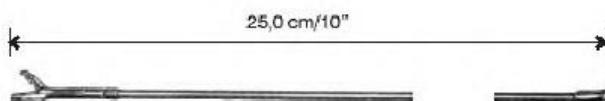

**Schuhmacher**

33.5047  
komplett, complete  
complet, completo



4 mm

**Schuhmacher**

33.5048  
Aufsatz allein  
Tip only  
Embout seul  
Punta sola



Biopsie zangen  
Biopsy punches  
Pincas emporte-pieces a biopsie  
Pinzas para biopsia



**Schubert**  
33.5051 21,0 cm/8¼"  
33.5052 29,0 cm/11½"

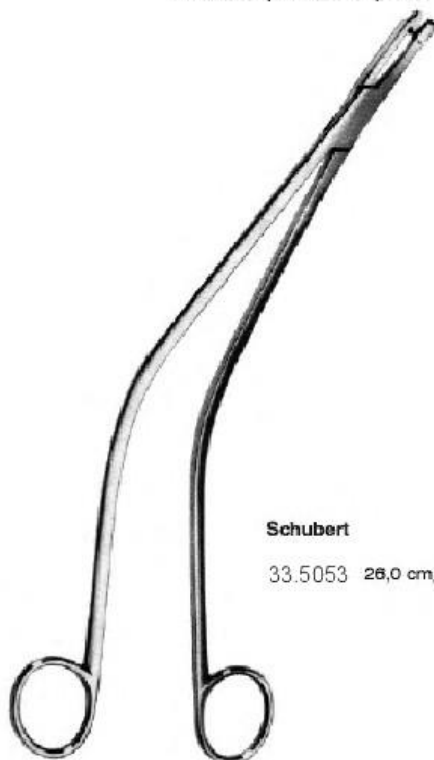

**Schubert**  
33.5053 26,0 cm/10¼"



**Tischler**  
33.5054  
27,0 cm/10½"

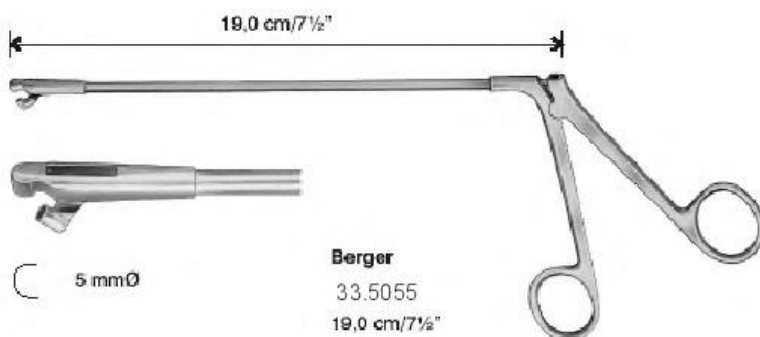

5 mmØ

**Berger**  
33.5055  
19,0 cm/7½"



**Alexander**  
33.5056  
28,0 cm/11"



Thoms-Gaylor

24,0 cm/9½"

33.5057



oekig  
angular  
angulaire  
angular

33.5058  
Van Doren  
24,0 cm/9½"



rund  
round  
ronde  
redonda

33.5059



Recamier  
31,0 cm/12¼"

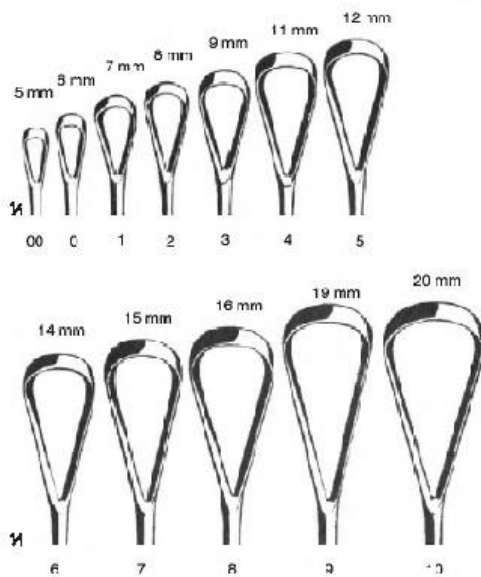

	mm	scharf, biegsam sharp, malleable tranchante, malléable cortante, maleable	scharf, fest sharp, rigid tranchante, rigide cortante, rigida	stumpf, biegsam blunt, malleable mousse, malléable roma, maleable	stumpf, fest blunt, rigid mousse, rigide roma, rigida
Fig. 00	5	33.5120-20	33.5130-20	33.5140-20	33.5150-20
Fig. 0	6	33.5120-00	33.5130-00	33.5140-00	33.5150-00
Fig. 1	7	33.5120-01	33.5130-01	33.5140-01	33.5150-01
Fig. 2	8	33.5120-02	33.5130-02	33.5140-02	33.5150-02
Fig. 3	9	33.5120-03	33.5130-03	33.5140-03	33.5150-03
Fig. 4	11	33.5120-04	33.5130-04	33.5140-04	33.5150-04
Fig. 5	12	33.5120-05	33.5130-05	33.5140-05	33.5150-05
Fig. 6	14	33.5120-06	33.5130-06	33.5140-06	33.5150-06
Fig. 7	15	33.5120-07	33.5130-07	33.5140-07	33.5150-07
Fig. 8	16	33.5120-08	33.5130-08	33.5140-08	33.5150-08
Fig. 9	19	33.5120-09	33.5130-09	33.5140-09	33.5150-09
Fig. 10	20	33.5120-10	33.5130-10	33.5140-10	33.5150-10
Fig. 11	21	33.5120-11	33.5130-11	33.5140-11	33.5150-11
Fig. 12	23	33.5120-12	33.5130-12	33.5140-12	33.5150-12
Fig. 13	25	33.5120-13	33.5130-13	33.5140-13	33.5150-13
Fig. 14	30	33.5120-14	33.5130-14	33.5140-14	33.5150-14
Fig. 15	35	33.5120-15	33.5130-15	33.5140-15	33.5150-15
Fig. 16	40	33.5120-16	33.5130-16	33.5140-16	33.5150-16

Uterus kuretten  
Uterine curettes  
Curettes uterines  
Curettas uterinas



Nasen spekula  
Nasal specula  
Speculums pour le nez  
Especulos nasales

**HNO-Instrumente**  
**ENT-Instruments**  
**Instruments ORL**  
**Instrumental ORL**



**Hartmann**  
16,5 cm/6½"

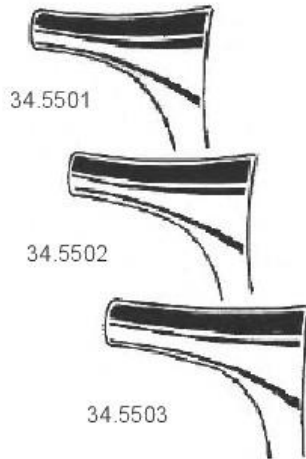

**Hartmann-Halle**  
15,0 cm/6"

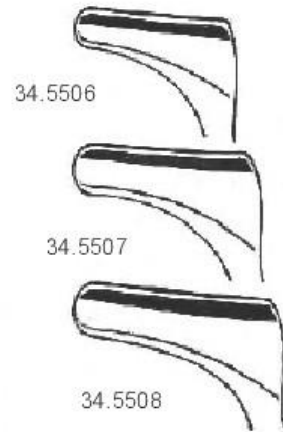

**Cottle**  
16,5 cm/6½"

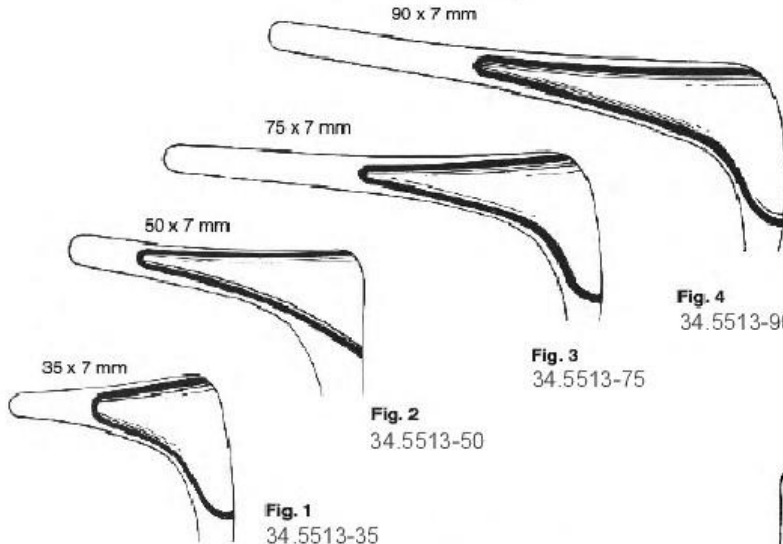

**Killian**  
13,0 cm/5"

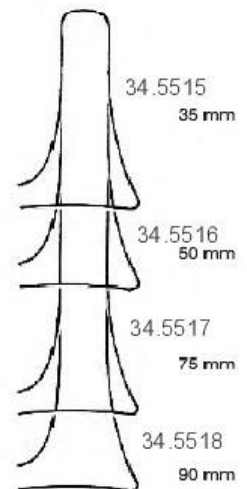

Polypen zangen  
Nasal polypus forceps  
Pinces a polypes nasaux  
Pinzas para polipos nasales



**Hartmann**

34.5549 13,0 cm/5"  
34.5550 16,0 cm/6¼"

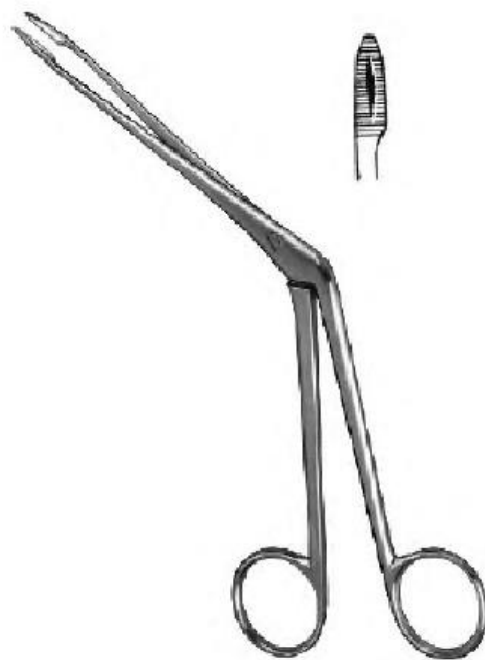

**Hartmann**

34.5551 20,0 cm/8"



**Heymann-Knight**

34.5552 18,0 cm/7"

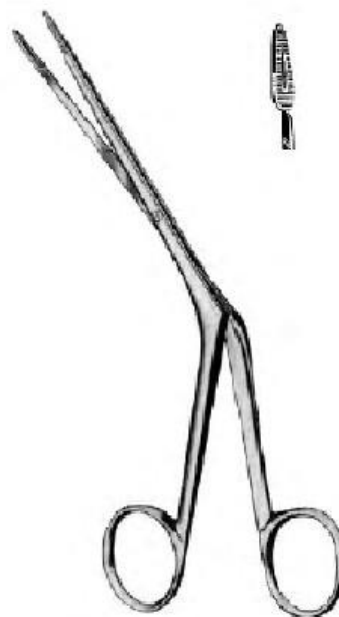

**Littauer**

34.5553 18,0 cm/7"

Nasen-und ohrpinzetten  
Nasal and ear dressing forceps  
Pincas nasales et auriculaires  
Pinzas nasales y auriculares



**Troeltsch (Wilde)**

- 34.5554 11,0 cm/4½"
- 34.5555 12,0 cm/4¾"
- 34.5556 15,0 cm/6"
- 34.5557 18,0 cm/7"



**Troeltsch (Wilde) 1 x 2**

- 34.5559 12,0 cm/4¾"
- 34.5560 15,0 cm/6"



bajonettförmig  
bayonet-shaped  
en forme de baïonette  
en forma de bayoneta

**Jansen**

- 34.5562 16,0 cm/6½"
- 34.5563 18,0 cm/7"

**Grünwald-Jansen**

20,0 cm/8"



**Lucae**

- 34.5565 14,0 cm/5½"



**Lucae 1 x 2**

- 34.5566 14,0 cm/5½"



**Cottle**

- 34.5567 14,0 cm/5½"

Mundsperrer  
Mouth gags  
Ouvre-bouches  
Abre-bocas



**Molt**

34.5814 11,0 cm/4½"  
34.5815 14,0 cm/5½"

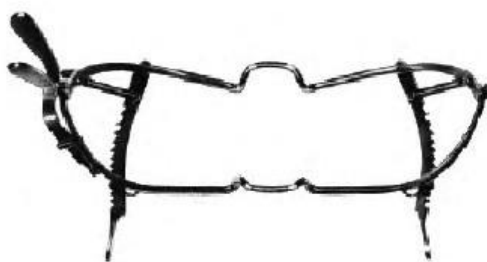

**Whitehead**

34.5821 11,0 cm/4½"  
34.5823 13,0 cm/5"  
34.5825 15,0 cm/6"



**Jennings**

34.5830 9,0 cm/3½"  
34.5831 11,0 cm/4½"  
34.5833 13,0 cm/5"  
34.5835 15,0 cm/6"



34.5883  
14,0 cm/5½"



**Buchwald**  
34.5884  
14,5 cm/5¾"

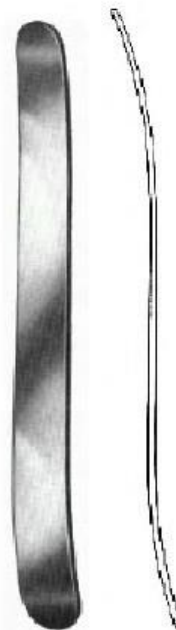

**Buchwald**  
34.5888  
18,0 cm/7"



**Bruenings**  
34.5890  
19,0 cm/7½"

Zungen spatel  
Tongue depressors  
Abaisse-langues  
Abaja-lenguas



massiv  
solid  
massif  
macizo

**Tobold**

34.5891  
14,5 cm/5¾"

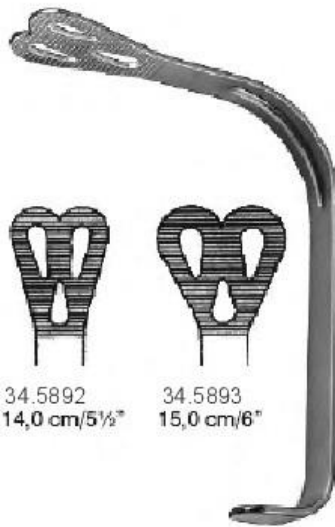

34.5892  
14,0 cm/5½"

34.5893  
15,0 cm/6"

**Wieder**



**Doyen**

34.5894 13,0 cm/5"  
34.5895 16,0 cm/6¼"



**Andrew**

34.5896  
11,0 cm/4½"



**Collin**

34.5900 17,0 cm/6¾"  
34.5901 19,0 cm/7½"

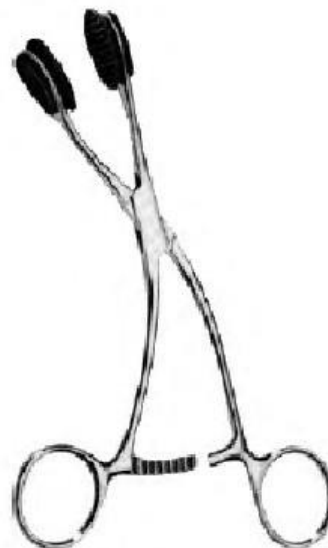

**Young**

34.5907 16,0 cm/6¼"

34.5907-02

Pair Ersatzgummi  
Pair of replacement rubber inserts  
Paire de caoutchouc de rechange  
Par de goma de recambio

Ohrzangchen  
Ear polypus forceps  
Pinces pour polypes auriculaires  
Pinzas para polipos

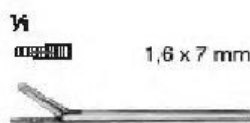
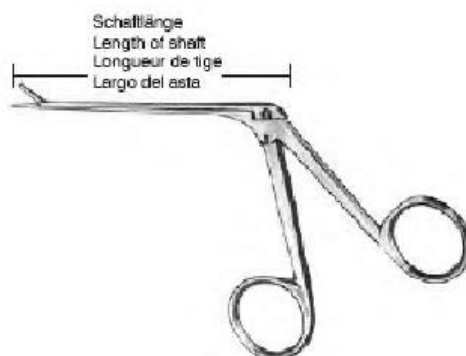

**Hartmann-Wullstein**  
34.6400 8,5 cm/3¼"  
Schaftlänge  
Length of shaft  
Longueur de tige  
Largo del asta

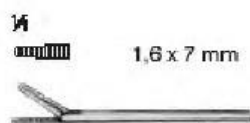

**Hartmann**  
34.6401-08 8,0 cm/3½"  
34.6401-14 14,0 cm/5½"  
34.6401-16 16,0 cm/6¼"  
Schaftlänge  
Length of shaft  
Longueur de tige  
Largo del asta

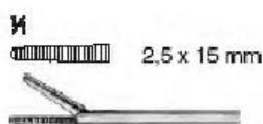

**Hartmann-Noyes**  
34.6406 8,0 cm/3½"  
Schaftlänge  
Length of shaft  
Longueur de tige  
Largo del asta

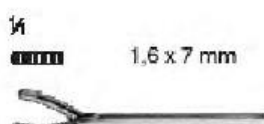

**Hartmann-Weingärtner**  
34.6407 8,0 cm/3½"  
Schaftlänge  
Length of shaft  
Longueur de tige  
Largo del asta

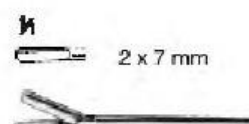

**Hartmann**  
34.6408 8,0 cm/3½"  
Schaftlänge  
Length of shaft  
Longueur de tige  
Largo del asta

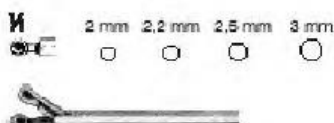

**Hartmann-Noyes**  
34.6409-20 2 mm 8,0 cm/3½"  
34.6409-22 2,2 mm Schaftlänge  
34.6409-25 2,5 mm Length of shaft  
34.6409-30 3 mm Longueur de tige  
Largo del asta

Löffelmaul  
Spoon-shaped jaw  
Mors en forme d'un cuiller  
Boca en forma de cucharilla

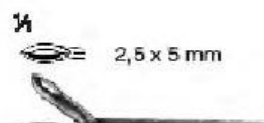

**Struempel**  
34.6410 8,0 cm/3½"  
Schaftlänge  
Length of shaft  
Longueur de tige  
Largo del asta

Ohrzangchen  
Ear polypus forceps  
Pinces pour polypes auriculaires  
Pinzas para polipos

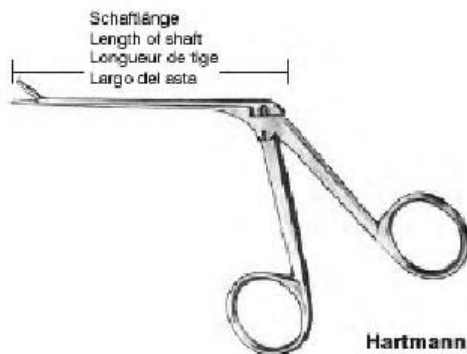

**mittelfein**

Schaft 1,2 x 1,8 mm  
Shaft 1,2 x 1,8 mm  
Tige 1,2 x 1,8 mm  
Asta 1,2 x 1,8 mm

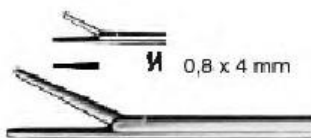

34.6420-01 7,5 cm/3"  
**glatt**  
smooth  
**lisse**  
lisa

Schaftlänge  
Length of shaft  
Longueur de tige  
Largo del asta



34.6421-01 7,5 cm/3"  
**gerieft**  
serrated  
**strié**  
estriada

Schaftlänge  
Length of shaft  
Longueur de tige  
Largo del asta

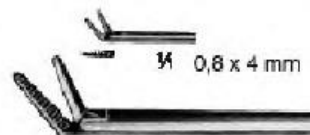

34.6421-02 7,5 cm/3"  
**gerieft**  
serrated  
**strié**  
estriada

Schaftlänge  
Length of shaft  
Longueur de tige  
Largo del asta

Schaft 1,6 x 2,6 mm  
Shaft 1,6 x 2,6 mm  
Tige 1,6 x 2,6 mm  
Asta 1,6 x 2,6 mm



34.6422  
**gerieft**  
serrated  
**strié**  
estriada

8,0 cm/3 1/2"  
Schaftlänge  
Length of shaft  
Longueur de tige  
Largo del asta

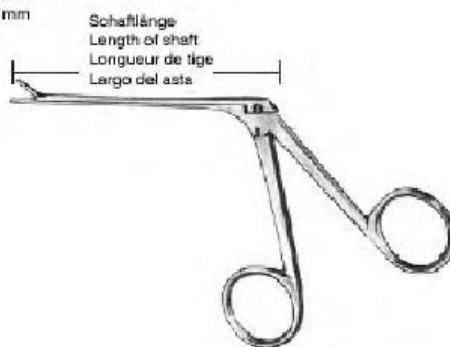

Iris pinzetten  
Iris forceps  
Pincés pour l'iris  
Pinzas para iris



**Elschnig**

35.7000  
10,5 cm/4 1/4"



Fixierpinzette  
Fixation Forceps  
Pince à fixation  
Pinzas de fijación



**Fischer**

35.7001  
7,0 cm/2 3/4"



**Gill**

35.7002  
7,5 cm/3"



**Gill-Hess**

35.7003  
7,5 cm/3"

Zähne unten  
Teeth downwards  
Dents vers le bas  
Dientes hacia abajo



35.7004  
Zähne seitwärts  
Teeth lateral  
Dents latérales  
Dientes laterales



**Graefe**  
10,0 cm/4"  
0,9 mm

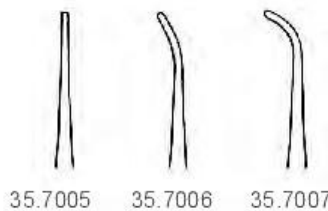

35.7005 35.7006 35.7007

gerieft  
serrated  
striée  
estriadas

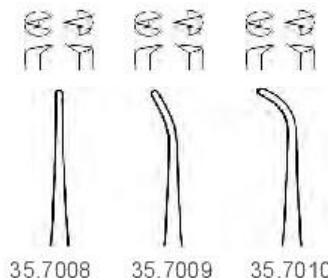

35.7008 35.7009 35.7010

**Augeninstrumente**  
**Ophthalmological Instruments**  
**Instrumentos oftalmologicos**  
**Instrumentos para oftalmologia**

**Iris pinzetten**  
**Iris forceps**  
**Pinces pour l'iris**  
**Pinzas para iris**



ohne Sperre  
without ratchet  
sans crémaillère  
sin cremallera



35.7012



35.7013



35.7014

gerieft  
serrated  
striée  
estriadas



35.7018

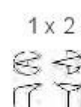

35.7019

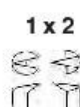

35.7020



mit Sperre  
with ratchet  
avec crémaillère  
con cremallera



35.7015



35.7016



35.7017

gerieft  
serrated  
striée  
estriadas



35.7021

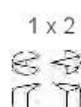

35.7022

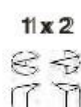

35.7023

**Stevens**  
10,5 cm/4¼"

**Stevens**  
10,5 cm/4¼"

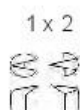

35.7024

35.7029



35.7025-01

35.7025-01  
7,0 cm/2¾"



35.7025-02

35.7025-02  
7,0 cm/2¾"

ohne Stift  
without pin  
sans cheville  
sin perno

mit Stift  
with pin  
avec cheville  
con perno



**Hess**  
7,0 cm/2¾"



**Mod. Bonn**



**Mod. Bonn**



**Bishop-Harmon**  
8,5 cm/3½"

35.7026-01  
0,8 mm  
gerieft  
serrated  
striée  
estriadas

35.7026-02  
0,4 mm  
gerieft  
serrated  
striée  
estriadas

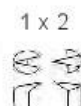

35.7027-01  
0,8 mm

35.7027-02  
0,4 mm



**Bishop-Harmon**  
8,5 cm/3½"

Kapsel pinzetten      Faden pinzetten  
Capsular forceps      Suture forceps  
Pincès à capsulaires      Pincès à sutures  
Pinzas capsulares      Pinzas para sutura

Kapselpinzetten, Capsular Forceps, Pincès capsulaires, Pinzas capsulares



**Gill-Arruga**

35.7050  
7,5 cm/3"



**Arruga**

35.7051  
9,5 cm/3¾"



**Schweiger**

35.7052  
10,0 cm/4"



**Pley**

35.7053  
9,0 cm/3½"

Kapselsauger  
Erisophakes  
Aspirateurs capsulaires  
Aspirador capsular



**Dastoor**

35.7054  
6,0 cm/2½"

Fadenpinzetten, Suture Forceps, Pincès à sutures, Pinzas para sutura



**McPherson**

35.7055-01  
8,5 cm/3½"



**McPherson**

35.7055-02  
8,5 cm/3½"



**McPherson**

35.7056-01  
8,5 cm/3½"



**McPherson**

35.7056-02  
8,5 cm/3½"



**McPherson**

35.7058-01  
10,0 cm/4"



**McPherson**

35.7058-02  
10,0 cm/4"

Fixier pinzetten  
Fixation forceps  
Pincés à fixation  
Pinzas de fijación

Naht pinzetten  
Suture forceps  
Pincés à sutures  
Pinzas para sutura



ohne Schloß  
without catch  
sans arrêt  
sin cierre

**Graefe**

35.7060  
11,0 cm/4½"



mit Schloß  
with catch  
avec arrêt  
con cierre

**Graefe**

35.7061  
11,0 cm/4½"



**Barraquer**

35.7062  
10,0 cm/4"

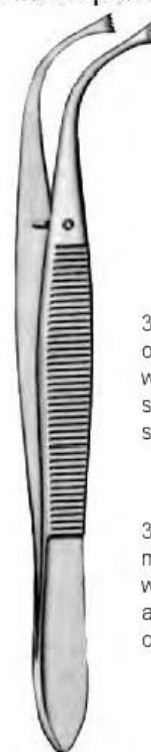

35.7063  
ohne Schloß  
without catch  
sans arrêt  
sin cierre

35.7064  
mit Schloß  
with catch  
avec arrêt  
con cierre

**Noyes**

11,0 cm/4½"



**Jess**

35.7065  
10,0 cm/4"



**Green**

10,0 cm/4"

35.7066 5 mm  
35.7067 10 mm  
mit Schloß  
with catch  
avec arrêt  
con cierre

35.7068 5 mm  
35.7069 10 mm  
ohne Schloß  
without catch  
sans arrêt  
sin cierre

2 x 2



Nahtpinzetten  
Suture Forceps  
Pincés à sutures  
Pinzas para sutura

35.7070  
gerade  
straight  
droite  
rectas

35.7071  
gebogen  
curved  
courbe  
curvas

**Castroviejo 2 x 2**

9,0 cm/3¾"

**Strabismus pinzetten**  
**Strabismus forceps**  
**Pinces à strabisme**  
**Pinzas de estrabismo**



Strabismuspinzette  
Strabismus Forceps  
Pinces à strabisme  
Pinzas para estrabismo

**Bonaccolto**

35.7080  
10,0 cm/4"

**Naht pinzetten**  
**Suture forceps**  
**Pinces à sutures**  
**Pinzas para sutura**



1 x 2



Nahtpinzetten  
Suture Forceps  
Pinces à sutures  
Pinzas para sutura

35.7084  
0,5 mm  
35.7085  
1,0 mm  
gerade  
straight  
droite  
rectas

**Castroviejo**  
10,0 cm/4"



1 x 2



Nahtpinzetten  
Suture Forceps  
Pinces à sutures  
Pinzas para sutura

35.7086  
0,5 mm  
35.7087  
1,0 mm  
gebogen  
curved  
courbe  
curvas

**Castroviejo**  
10,0 cm/4"



1 x 2



Nahtpinzetten  
Suture Forceps  
Pinces à sutures  
Pinzas para sutura

35.7088-05  
0,5 mm  
35.7088-09  
0,9 mm  
35.7088-15  
1,5 mm  
gerade  
straight  
droite  
rectas

**Castroviejo**  
10,0 cm/4"

1 x 2



Nahtpinzetten  
Suture Forceps  
Pinces à sutures  
Pinzas para sutura

**St. Martin**

35.7089  
7,0 cm/2¾"

gerieft  
serrated  
striée  
estriadas



Strabismuspinzette  
Strabismus Forceps  
Pinces à strabisme  
Pinzas para estrabismo

35.7090  
11,0 cm/4½"

gerieft  
serrated  
striée  
estriadas



Strabismuspinzette  
Strabismus Forceps  
Pinces à strabisme  
Pinzas para estrabismo

35.7091  
11,0 cm/4½"

Strabismus pinzetten  
Strabismus forceps  
Pincès à strabisme  
Pinzas de estrabismo

Naht pinzetten  
Suture forceps  
Pincès à sutures  
Pinzas para sutura

Chalazionspinzetten, Chalazion Forceps, Pincès à chalazion, Pinzas para chalación

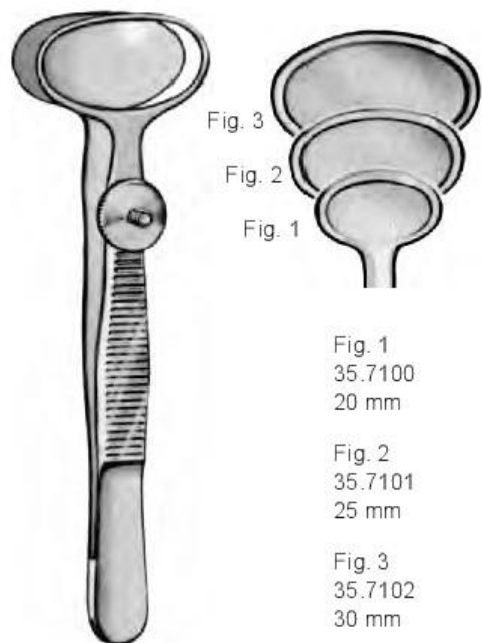

Fig. 3  
Fig. 2  
Fig. 1

Fig. 1  
35.7100  
20 mm  
Fig. 2  
35.7101  
25 mm  
Fig. 3  
35.7102  
30 mm

**Desmarres**  
9,0 cm/3½"



mit Schraube  
with screw  
avec vis  
con tornillo

**Ayer**

35.7103  
9,0 cm/3½"



Trachompinzette  
Trachoma Forceps  
Pince pour le trachome  
Pinzas para tracoma

**Prince**

35.7110  
9,0 cm/3½"



Strabismuspinzette  
Strabismus Forceps  
Pincès à strabisme  
Pinzas para estrabismo



	Zähne Teeth Griffes Dientes
35.7112	1 x 2
35.7113	2 x 3
35.7114	3 x 4

10,0 cm/4"



Nahtpinzette  
Suture Forceps  
Pincès à sutures  
Pinzas para sutura

35.7115  
mit Schloß  
with catch  
avec arrêt  
con cierre

35.7116  
ohne Schloß  
without catch  
sans arrêt  
sin cierre

**Castroviejo**  
1 x 1  
9,0 cm/3½"

Lidhalter  
Lid retractors  
Ecarteurs à paupières  
Separadores de párpados

Markierungszirkel  
Marker graduated  
Marqueur gradué  
Marcador graduado

Lidhalter, Lid Retractor, Ecarteurs à paupières, Separadores de párpados

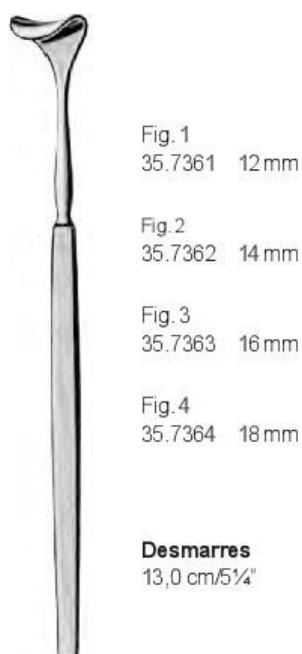

Markierungszirkel, Marker graduated, Marqueur gradué, Marcador graduado



Messbereich  
Measuring Range  
Echelle  
Alcance de medición

35.7370 15 mm  
35.7371 20 mm

**Castroviejo**

Mikro-scheren    Nachstar scheren  
 Micro scissors    Secondary cataract scissors  
 Micro-ciseaux    Ciseaux pour la cataracte secondaire  
 Micro tijeras    Tijeras para catarata secundaria

Nachstarscheren, Secondary Cataract Scissors  
 Ciseaux pour la cataracte secondaire, Tijeras para catarata secundaria

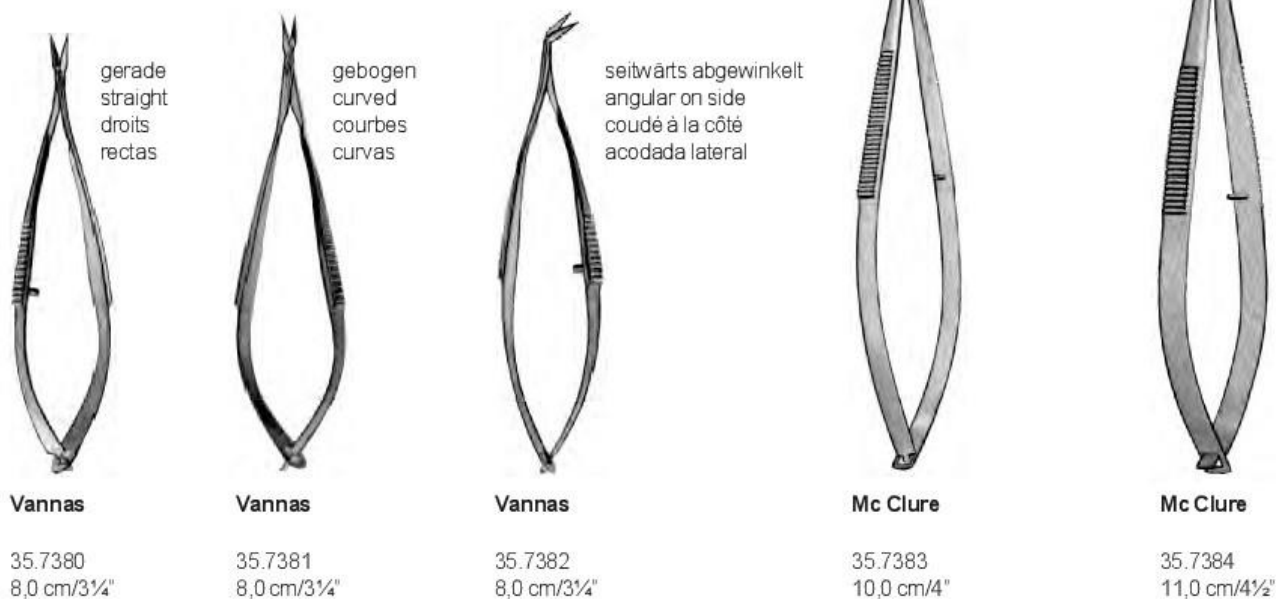

Mikro-Hornhautscheren, Micro Corneal Scissors, Micro-Ciseaux pour la corneé, Micro Tijeras para córnea



Hornhaut scheren  
Corneal scissors  
Ciseaux pour la corneé  
Tijeras para córnea

Iridektomie scheren  
Iridectomy scissors  
Ciseaux à iridectomie  
Tijeras para iridectomia

Hornhautscheren, Corneal Scissors, Ciseaux pour la corneé, Tijeras para córnea



links  
to the left  
à gauche  
a la izquierda

**Katzin**

35.7389  
10,0 cm/4"



rechts  
to the right  
à droite  
a la derecha

**Katzin**

35.7390  
10,0 cm/4"



links  
to the left  
à gauche  
a la izquierda

**Katzin**

35.7391  
10,0 cm/4"

mit Sperre  
with ratchet  
avec arrêt  
con cierre



rechts  
to the right  
à droite  
a la derecha

**Katzin**

35.7392  
10,0 cm/4"

Hornhautscheren  
Corneal Scissors  
Ciseaux pour la corneé  
Tijeras para córnea



**Mc Guire**

35.7393  
10,0 cm/4"

Iridektomieschere  
Iridectomy Scissors  
Ciseaux à iridectomie  
Tijeras para iridectomia



**Noyes**

35.7394  
12,0 cm/4¾"

Hornhautscheren  
Corneal Scissors  
Ciseaux pour la corneé  
Tijeras para córnea



seitwärts abgewinkelt  
angular on side  
coudé à la côté  
acodada lateral

**Castroviejo**

35.7395  
9,0 cm/3½"

Sehnenschere  
Tenotomy Scissors  
Ciseaux à ténatomie  
Tijeras para tenotomia



spitz  
pointed  
pointus  
agudos

stumpf  
blunt  
mousses  
romos

**Westcott**

35.7396  
11,0 cm/4½"

**Westcott**

35.7397  
11,0 cm/4½"

Iridektomie scheren

Iridectomy scissors

Ciseaux à iridectomie

Tijeras para iridectomia

Rundgriff scheren

Micro scissors

Ciseaux avec manche ronde

Tijeras con mango redondo

Iridektomiescheren, Iridectomy Scissors, Ciseaux à iridectomie, Tijeras para iridectomia

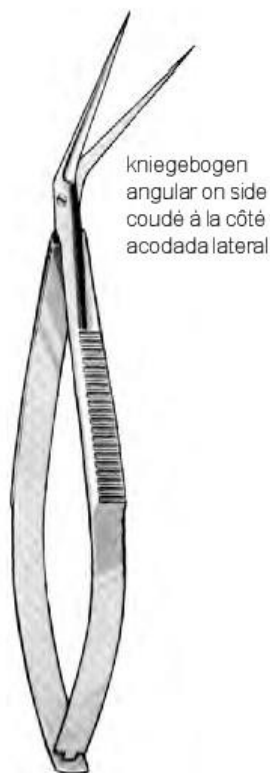

kniegebogen  
angular on side  
coudé à la côté  
acodada lateral

35.7398  
11,0 cm/4½"



gebogen  
curved  
courbes  
curvas

35.7399  
11,0 cm/4½"



gerade  
straight  
droits  
rectas

35.7400  
9,0 cm/3½"



35.7401  
9,0 cm/3½"  
gebogen  
curved  
courbes  
curvas



35.7402  
9,0 cm/3½"  
kniegebogen  
angular on side  
coudé à la côté  
acodada lateral

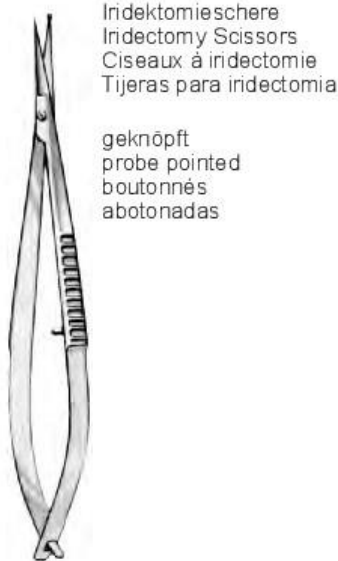

Iridektomieschere  
Iridectomy Scissors  
Ciseaux à iridectomie  
Tijeras para iridectomia

geknöpft  
probe pointed  
boutonnés  
abotonadas

35.7403  
9,0 cm/3½"



35.7404  
18,0 cm/7"

Iridektomiescheren  
Iridectomy Scissors  
Ciseaux à iridectomie  
Tijeras para iridectomia



35.7404  
gerade  
straight  
droits  
rectas



35.7405  
gebogen  
curved  
courbes  
curvas



35.7406  
gerade  
straight  
droits  
rectas



35.7407  
gebogen  
curved  
courbes  
curvas

Rundgriffschere, langes Modell  
Micro Scissors with round handle, extra long  
Ciseaux avec manche ronde, modèle long  
Tijeras con mango redondo, modelo largo

Iridektomiescheren  
Iridectomy Scissors  
Ciseaux à iridectomie  
Tijeras para iridectomia



Fig. 1  
35.7408



Fig. 2  
35.7409



Fig. 3  
35.7410

**Noyes**  
12,0 cm/4¾"

Iridektomie scheren  
Iridectomy scissors  
Ciseaux à iridectomie  
Tijeras para iridectomia

Hornhaut scheren  
Corneal scissors  
Ciseaux pour la corneé  
Tijeras para córnea

Hornhautscheren  
Corneal Scissors  
Ciseaux pour la corneé  
Tijeras para córnea



links  
to the left  
à gauche  
a la izquierda

**Castroviejo**

35.7411  
11,0 cm/4½"



rechts  
to the right  
à droite  
a la derecha

**Castroviejo**

35.7412  
11,0 cm/4½"

Hornhautscheren, Corneal Scissors, Ciseaux pour la corneé, Tijeras para córnea



gebogen  
curved  
courbes  
curvas

**Castroviejo**

35.7413  
9,0 cm/3½"



links  
to the left  
à gauche  
a la izquierda

**Castroviejo**

35.7414  
11,0 cm/4½"

feines Modell  
delicate pattern  
modèle fin  
modelo fino



rechts  
to the right  
à droite  
a la derecha

**Castroviejo**

35.7415  
11,0 cm/4½"

Iridektomie scheren      Hornhaut scheren  
Iridectomy scissors      Corneal scissors  
Ciseaux à iridectomie      Ciseaux pour la corneé  
Tijeras para iridectomia      Tijeras para córnea

Iridektomiescheren, Iridectomy Scissors, Ciseaux à iridectomie, Tijeras para iridectomia

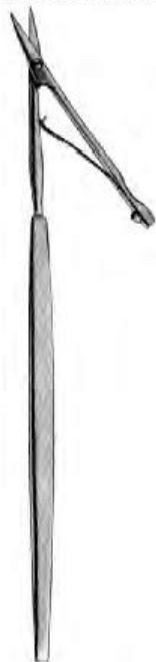

**Noyes**

35.7416  
15,0 cm/6"



**Wecker**

11,0 cm/4½"



Fig. 1  
35.7417



Fig. 2  
35.7418



Fig. 3  
35.7419



Fig. 4  
35.7420



Fig. 5  
35.7421



Fig. 6  
35.7422

fein  
delicate  
fins  
finos

Hornhautscheren  
Corneal Scissors  
Ciseaux pour la corneé  
Tijeras para córnea



spitz  
pointed  
pointus  
agudos

**Castroviejo**

35.7423  
10,0 cm/4"



stumpf  
blunt  
mousses  
romos

**Castroviejo**

35.7424  
10,0 cm/4"

Iridektomiescheren  
Iridectomy Scissors  
Ciseaux à iridectomie  
Tijeras para iridectomia



**Barraquer**

5,5 cm/2¼"



Fig. 1  
35.7425



Fig. 2  
35.7426



Fig. 3  
35.7427



Fig. 4  
35.7428



Fig. 5  
35.7429



Fig. 6  
35.7430

fein  
delicate  
fins  
finos

Iris scheren  
 Iris scissors  
 Ciseaux pour l'iris  
 Tijeras para iris



kantige Ausführung  
 square shanks  
 modèle anguleux  
 modelo anguloso

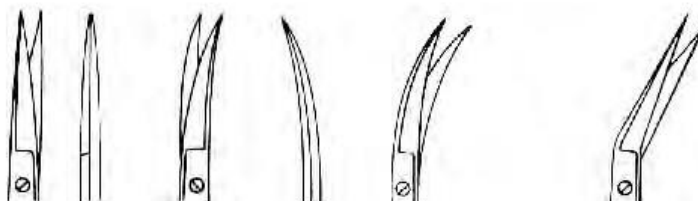

	gerade straight droits rectas	gebogen curved courbes curvas	seitwärts gebogen curved sideways courbe à la côté curva lateral	seitwärts abgewinkelt angular on side coudé à la côté acodada lateral
9,0 cm/3½"	35.7450	35.7451	35.7452	35.7453
10,5 cm/4¼"	35.7454	35.7455	35.7456	35.7457
11,5 cm/4¾"	35.7458	35.7459	35.7460	35.7461



runde Ausführung  
 round shanks  
 modèle rond  
 modelo redondo

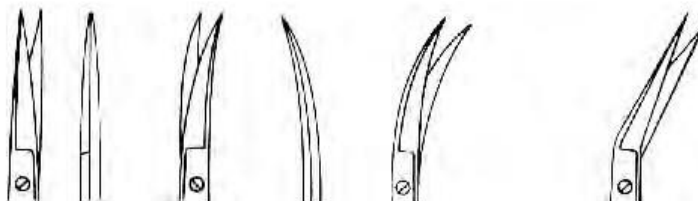

	gerade straight droits rectas	gebogen curved courbes curvas	seitwärts gebogen curved sideways courbe à la côté curva lateral	seitwärts abgewinkelt angular on side coudé à la côté acodada lateral
9,0 cm/3½"	35.7470	35.7471	35.7472	35.7473
10,5 cm/4¼"	35.7474	35.7475	35.7476	35.7477
11,5 cm/4¾"	35.7478	35.7479	35.7470	35.7481

Iris scheren      Augen scheren  
Iris scissors      Eye scissors  
Ciseaux pour l'iris      Ciseaux oculaires  
Tijeras para iris      Tijeras oculares



Irisschere  
Iris Scissors  
Ciseaux pour l'iris  
Tijeras para iris

**Graefe**

35.7483  
10,5 cm/4¼"



Augenschere  
Eye Scissors  
Ciseaux oculaires  
Tijeras oculares

**Le Grange**

35.7485  
10,5 cm/4¼"

Sehnenscheren, Tenotomy Scissors, Ciseaux à ténatomie, Tijeras para tenotomía



**Stevens**  
spitz  
pointed  
pointus  
agudas



35.7490 10,0 cm/4"  
35.7492 11,0 cm/4½"  
gerade  
straight  
droits  
rectas



35.7491  
35.7493  
gebogen  
curved  
courbes  
curvas



**Stevens**  
stumpf  
blunt  
mousses  
romas



35.7494 10,0 cm/4"  
35.7496 11,0 cm/4½"  
gerade  
straight  
droits  
rectas



35.7495  
35.7497  
gebogen  
curved  
courbes  
curvas

# Verschiedene Behälter

## Different Containers

### Boîtes

### diverses Contenedores varios

### Vassoi diversi

Deckel ohne Knopf  
lid without knob  
couvreclé sans bouton  
tapa sin botón  
coperchio senza bottone



Instrumentenkästen  
Instrument Boxes  
Boîtes pour instruments  
Cajas para instrumentos  
Scatole per strumenti

	L x B x H
<b>88.120.16</b>	165x 85x 35 mm
<b>88.120.20</b>	200x100x 60 mm
<b>88.120.22</b>	220x120x 60 mm
<b>88.120.23</b>	230x130x 50 mm
<b>88.120.26</b>	260x150x 50 mm
<b>88.120.30</b>	280x140x 60 mm
<b>88.120.50</b>	500x200x120 mm

mit Knopfdeckel  
lid with knob  
avec couvercle à bouton  
tapa con botón  
con coperchio a bottone



Instrumentenkästen  
Instrument Boxes  
Boîtes pour instruments  
Cajas para instrumentos  
Scatole per strumenti

	L x B x H
<b>88.123.32</b>	320x100x50 mm
<b>88.123.43</b>	430x100x35 mm

mit Knopfdeckel  
lid with knob  
avec couvercle à bouton  
tapa con botón  
con coperchio a bottone



Instrumentenkästen  
Instrument Boxes  
Boîtes pour instruments  
Cajas para instrumentos  
Scatole per strumenti

	L x B x H
<b>88.124.17</b>	170x120x60 mm
<b>88.124.20</b>	200x 60x40 mm
<b>88.124.22</b>	220x100x50 mm
<b>88.124.23</b>	220x140x60 mm
<b>88.124.27</b>	270x170x60 mm
<b>88.124.30</b>	300x180x65 mm

Verschiedene behälter  
 Different containers  
 Boîtes diverses  
 Varios contenedores  
 Vassoi diversi

Wattspender  
 Cotton dispensers  
 Distributeurs de coton  
 Dispensores de algodón  
 Distributore del cotone



	Ø x H	
<b>88.127.10</b>	75x	60 mm
<b>88.127.11</b>	75x	75 mm
<b>88.127.20</b>	100x	60 mm
<b>88.127.21</b>	100x	100 mm
<b>88.127.30</b>	125x	80 mm
<b>88.127.31</b>	125x	125 mm
<b>88.127.40</b>	150x	150 mm

Metallschalen  
 Stainless Steel Bowls  
 Cuvettes de acier inoxydable  
 Cubetas de acero inoxidable  
 Scodelle di acciaio inossidabile



	Ø x H		
<b>88.130.04</b>	40x	19 mm	(0.05 Liter)
<b>88.130.06</b>	61x	30 mm	(0.07 Liter)
<b>88.130.08</b>	80x	40 mm	(0.14 Liter)
<b>88.130.12</b>	116x	50 mm	(0.35 Liter)
<b>88.130.13</b>	128x	55 mm	(0.45 Liter)
<b>88.130.15</b>	147x	65 mm	(0.70 Liter)
<b>88.130.16</b>	157x	75 mm	(1.10 Liter)
<b>88.130.19</b>	187x	85 mm	(1.60 Liter)

Metallschalen  
 Stainless Steel Bowls  
 Cuvettes de acier inoxydable  
 Cubetas de acero inoxidable  
 Scodelle di acciaio inossidabile



	Ø x H	
<b>88.131.01</b>	42x	30 mm
<b>88.131.02</b>	53x	34 mm
<b>88.131.03</b>	58x	40 mm
<b>88.131.04</b>	64x	48 mm
<b>88.131.05</b>	68x	47 mm
<b>88.131.06</b>	71x	46 mm
<b>88.131.07</b>	71x	50 mm
<b>88.131.08</b>	81x	51 mm
<b>88.131.09</b>	81x	54 mm
<b>88.131.10</b>	89x	47 mm
<b>88.131.11</b>	100x	48 mm
<b>88.131.12</b>	100x	53 mm

Verschiedene behälter  
 Different containers  
 Boîtes diverses  
 Varios contenedores  
 Vassoi diversi



Waschschüsseln  
 Wash Bowls  
 Cuvettes  
 Palanganas  
 Scodelle per liquidi

	Ø x H
<b>88.132.01</b>	300x100 mm
<b>88.132.02</b>	350x100 mm
<b>88.132.03</b>	400x100 mm
<b>88.132.04</b>	330x 90 mm
<b>88.132.05</b>	330x115 mm



Runde Schüsseln  
 Round Bowls  
 Cuvettes rondes  
 Cubetas redondas  
 Scodelle rotonde

	Ø x H	
<b>88.133.16</b>	150x 74 mm	(0.75 Liter)
<b>88.133.17</b>	160x 65 mm	(1.00 Liter)
<b>88.133.22</b>	220x 70 mm	(2.00 Liter)
<b>88.133.23</b>	230x 80 mm	(2.50 Liter)
<b>88.133.24</b>	260x130 mm	(4.50 Liter)
<b>88.133.25</b>	255x115 mm	(3.50 Liter)
<b>88.133.27</b>	275x115 mm	(5.00 Liter)
<b>88.133.29</b>	300x105 mm	(6.00 Liter)
<b>88.133.38</b>	400x150 mm	(14.00 Liter)



Spülschale  
 Solution Bowls  
 Cuvettes rondes  
 Cubetas redondas  
 Scodelle rotonde

	Ø x H
<b>88.133.31</b>	300x120 mm
<b>88.133.34</b>	350x130 mm
<b>88.133.41</b>	400x140 mm



Nierenschalen  
 Kidney bowls  
 Bassins réniformes  
 Riñoneras  
 Padelle reniformi

	L x B x H
<b>88.139.17</b>	170x100x30 mm
<b>88.139.20</b>	200x120x35 mm
<b>88.139.25</b>	250x140x40 mm
<b>88.139.27</b>	275x150x50 mm
<b>88.139.30</b>	300x160x50 mm
<b>88.139.40</b>	400x200x60 mm

Verschiedene behälter  
 Different containers  
 Boîtes diverses  
 Varios contenedores  
 Vassoi diversi



Instrumententabletts  
 Instrument Trays  
 Plateaux pour instruments  
 Bandejas para instrumentos  
 Bacinelle per strumenti

L x B x H

**88.142.19** 190x100x13 mm  
**88.142.20** 200x100x13 mm



Instrumententabletts  
 Instrument Trays  
 Plateaux pour instruments  
 Bandejas para instrumentos  
 Bacinelle per strumenti

L x B x H

**88.143.19** 190x100x13 mm  
**88.143.20** 200x100x13 mm  
**88.143.45** 450x300x32 mm

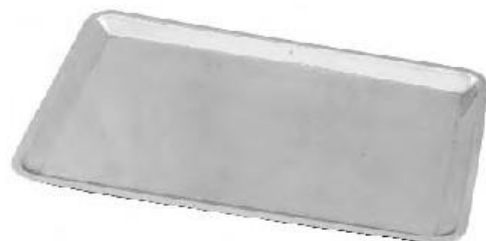

Instrumententabletts  
 Instrument Trays  
 Plateaux pour instruments  
 Bandejas para instrumentos  
 Bacinelle per strumenti

L x B x H

**88.145.21** 210x160x10 mm  
**88.145.24** 240x180x10 mm  
**88.145.29** 290x190x10 mm  
**88.145.30** 310x150x10 mm  
**88.145.32** 300x200x20 mm  
**88.145.33** 300x245x16 mm  
**88.145.35** 350x240x10 mm  
**88.145.38** 385x265x16 mm  
**88.145.39** 385x210x10 mm  
**88.145.40** 400x270x20 mm  
**88.145.42** 420x280x10 mm  
**88.145.43** 430x295x16 mm  
**88.145.49** 485x320x16 mm  
**88.145.51** 510x380x30 mm  
**88.145.59** 590x380x30 mm



Mehrzweckschalen  
 Universal Trays  
 Plateaux universaux  
 Bandejas universales  
 Bacinelle universali

L x B x H

**88.146.22** 220x170x50 mm  
**88.146.28** 300x175x30 mm  
**88.146.30** 300x175x40 mm  
**88.146.32** 300x200x50 mm  
**88.146.35** 350x240x36 mm  
**88.146.37** 400x300x50 mm  
**88.146.42** 450x350x50 mm