

INSDINIA S.L.
— INSTRUMENTAL QUIRÚGICO —

CONTENTS

INHALT

EXTRACTION

Extracting Forceps.....	05	Zahnzangen
Rongeur Forceps.....	25	Hohlmeißelzangen
Elevators.....	29	Wurzelheber

EXTRAKTION

SURGERY

Scalpels.....	45	Skalpell
Scissors.....	48	Scheren
Dissecting Forceps.....	56	Pinzetten
Haemostatic Forceps.....	60	Klemmen
Bone Curettes / Periosteal Elevators.....	62	Scharfe Löffel / Raspatorien
Chisels / Mallets.....	70	Meißel / Hämmer
Implantology.....	76	Implantologie
Retractors / Mouth Gags.....	81	Wund- / Wangen- / Zungenhalter
Needle Holders.....	87	Nadelhalter
Accessories.....	91	Zubehör

CHIRURGIE

DIAGNOSIS

Mouth Mirrors.....	96	Mundspiegel
Tweezers.....	98	Pinzetten
Explorers / Perio Probes.....	102	Zahnsonden / PA-Sonden

DIAGNOSTIK

PERIODONTIA

Scalers.....	110	Scaler
Curettes.....	115	Kürette
Gingivectomy.....	125	Gingivektomie

PARODONTOLOGIE

CONSERVATIVE DENTISTRY

Enamel Chisels / Gingival Margin Trimmers.....	130	Schmelzmeißel / Gingivalrandschräger
Excavators.....	132	Exkavatoren
Matrix Retainers and Matrixes.....	137	Matrizenspanner und Matrizen
Amalgam Carriers.....	138	Amalgampistolen
Filling Instruments.....	140	Füllungsinstrumente
Composite Instruments.....	149	Composite Instrumente
Carving Instruments.....	151	Modellierinstrumente
Cement Spatulas.....	159	Zementspatel
Rubber Dam Instruments.....	160	Kofferdaminstrumente
Endodontia.....	162	Endodontie

KONSERVIERENDE BEHANDLUNG

PROSTHODONTIA/ ORTHODONTIA

Carving Instruments.....	168	Modellierinstrumente
Knives / Spatulas.....	172	Messer / Spatel
Crown Instruments.....	176	Kroneninstrumente
Impression Trays.....	184	Abdrucklöffel
Pliers.....	192	Zangen

PROTHETIK/ ORTHODONTIE

Alphabetical Index.....	208	Alphabetischer Index
-------------------------	-----	----------------------

Numerical Index.....	224	Numerischer Index
----------------------	-----	-------------------

CONTENU

EXTRACTION

Daviers.....	05	Fórceps
Pinces Gouges.....	25	Pinzas Gubias
Elévateurs.....	29	Botadores

CHIRURGIE

Bistouris.....	45	Bisturís
Ciseaux.....	48	Tijeras
Pinces à Dissection.....	56	Pinzas de Disección
Pinces Hémostatiques.....	60	Pinzas Hemostáticas
Curettes Osseuses / Rugines.....	62	Curetas Óseas / Periostotomos
Burins / Gouges / Maillets.....	70	Cinceles / Martillos
Implantologie.....	76	Implantología
Ecarteurs / Ouvre-Bouches.....	81	Separadores / Abre-Bocas
Porte-Aiguilles.....	87	Porta-Agujas
Accessoires.....	91	Accesorios

DIAGNOSTIC

Miroirs à Bouche.....	96	Espejos de Boca
Précèlles.....	98	Pinzas
Sondes.....	102	Sondas

PARODONTOLOGIE

Instruments à Détrarrer.....	110	Limpiadores de Sarro
Curettes.....	115	Curetas
Gingivectomie.....	125	Gingivectomía

DENTISTERIE CONSERVATRICE

Ciseaux à Email / Finisseurs à Bords Gingivaux.....	130	Cinceles para Esmalte / Recortadores del Margen Gingival
Excavateurs.....	132	Excavadores
Porte-Matrices et Matrices.....	137	Portamatrices y Matrices
Porte-Amalgames.....	138	Porta Amalgamas
Instruments pour Obturations.....	140	Instrumentos para Obturaciones
Instruments pour Composite.....	149	Instrumentos para Composite
Instruments à Modèler.....	151	Instrumentos para Modèler
Spatulas à Ciment.....	159	Espátulas para Cemento
Instruments pour Digue de Caoutchouc.....	160	Instrumentos para Digue de Goma
Endodontie.....	162	Endodoncia

PROTHÈSE/ ORTHODONTIE

Instruments à Modèler.....	168	Instrumentos para Modèler
Couteaux / Spatulas.....	172	Cuchillos / Espátulas
Instruments à Couronnes.....	176	Instrumentos para Coronas
Porte-Empreintes.....	184	Cubetas de Impresiones
Pinces.....	192	Pinzas

CONTENIDO

EXTRACCIÓN

CIRUGÍA

DIAGNÓSTICO

PERIODONCIA

ODONTOLOGÍA DE CONSERVACIÓN

PROSTODONCIA/ ORTODONCIA

Index Alphabétique.....	208	Índice Alfabético
-------------------------	-----	-------	-------------------

Index Numérique.....	224	Índice Numérico
----------------------	-----	-------	-----------------



36

**EXTRACTION
EXTRAKTION
EXTRACTION
EXTRACCIÓN**

Karogriff

Handle with diamond profile

Manche à carreaux

Mango con forma de diamante



36.100-1



11-13, 21 - 23



36.100-2



11-13, 21 - 23



36.150-1

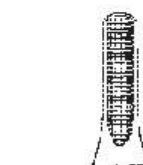

36.150-2



11-13, 21 - 23



36.100-7



14 -15, 24 -25



36.110-7



14 -15, 24 -25



36.150-7



36.101-36 GUY



14 -15, 24 -25

36

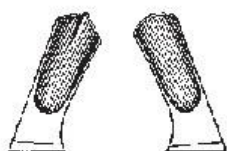

36.100-17



16-18

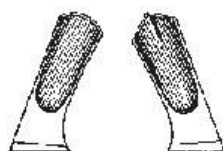

36.100-18



26-28

Karogriff
Handle with diamond profile
Manche à carreaux
Mango con forma de diamante

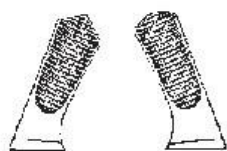

36.150-17



36.150-18

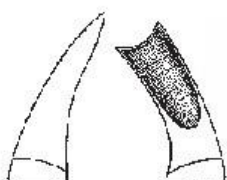

36.100-89



16-18

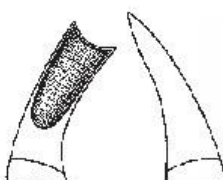

36.100-90



26-28

36



36.100-67



18, 28



36.100-67A



18, 28



36.150-67



36.150-67A

Karogriff
Handle with diamond profile
Manche à carreaux
Mango con forma de diamante



Wurzeln · roots
racines · raíces



Wurzeln · roots
racines · raíces

36



Wurzeln · roots
racines · raíces



Wurzeln · roots
racines · raíces



Wurzeln · roots
racines · raíces

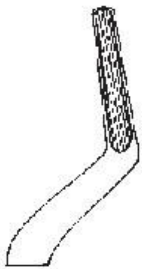

36.100-51

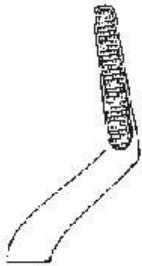

36.150-51



Wurzeln·roots
racines·raíces



36.100-51F



Wurzeln·roots
racines·raíces

Karogriff
Handle with diamond profile
Manche à carreaux
Mango con forma de diamante



36



36.100-51A

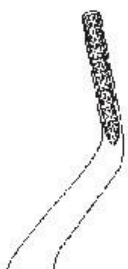

36.150-51A



Wurzeln·roots
racines·raíces



36.100-51C



Wurzeln·roots
racines·raíces

Karogriff
Handle with diamond profile
Manche à carreaux
Mango con forma de diamante



36.100-4



36.150-4



31-33, 41-43

36



36.100-13



36.150-13



34-35, 44-45



36.110-13



34-35, 44-45



36.100-75



36.150-75



34-35, 44-45



Karogriff
Handle with diamond profile
Manche à carreaux
Mango con forma de diamante



36



Karogriff

Handle with diamond profile

Manche à carreaux

Mango con forma de diamante

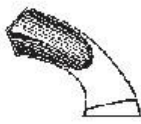

36.100-21



36-37, 46-47



36.100-87

36-37, 46-47

36



36.100-79



36.150-79

38, 48



36.100-79A



38, 48



36.228L

Routurier



38



36.228R

Routurier



48



36.100-33

36.150-33

Wurzeln · roots
racines · raíces



36.100-33A

36.150-33A

Wurzeln · roots
racines · raíces

Karogriff
Handle with diamond profile
Manche à carreaux
Mango con forma de diamante



36.100-33C

Wurzeln · roots
racines · raíces



36.100-35F

Wurzeln · roots
racines · raíces



36.100-74

36.150-74

Wurzeln · roots
racines · raíces



36.100-74N

36.150-74N

Wurzeln · roots
racines · raíces



36.100-74F

Wurzeln · roots
racines · raíces

Anatomischer Griff
Anatomic handle
Manche anatomique
Mango anatómico



diamantiert, diamond coating, couche de diamant, capa de diamante

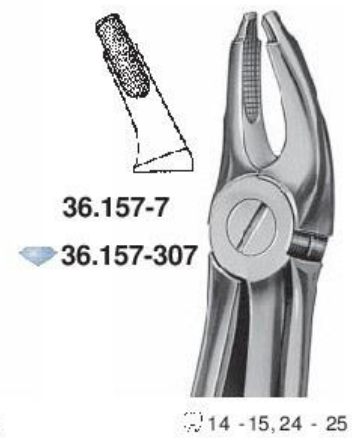
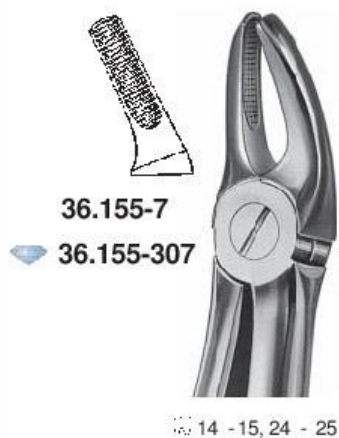
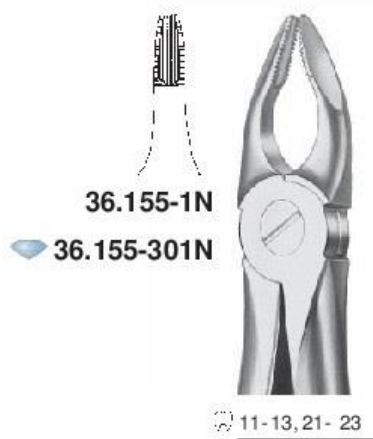
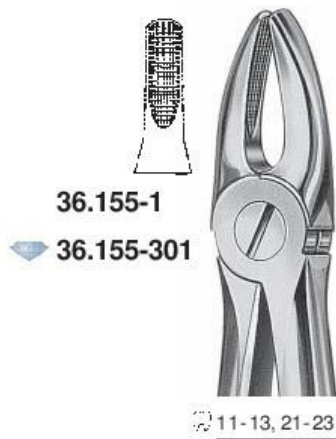

36





Wurzeln·roots
racines·raíces



Wurzeln·roots
racines·raíces



Wurzeln·roots
racines·raíces



Wurzeln·roots
racines·raíces



18, 28

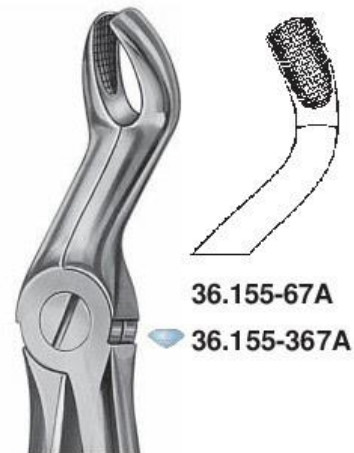

18, 28

Anatomischer Griff
Anatomic handle
Manche anatomique
Mango anatómico



diamantiert, diamond coating, couche de diamant, capa de diamante



36.155-13

36.155-313

31-35, 41-45



36.157-13

36.157-313

34-35, 44-45



36



36.157-13N

36.157-313N

34-35, 44-45



36.155-22

36.155-322

36-37, 46-47



36.155-86A

36-37, 46-47



36.155-86C

36-37, 46-47



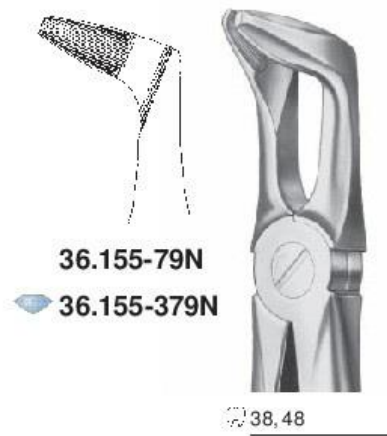
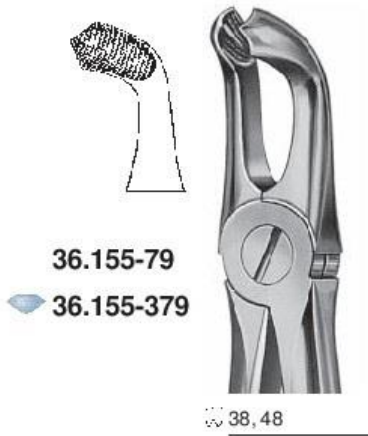



diamantiert, diamond coating, couche de diamant, capa de diamante

36.171 STIEGLITZ
Wurzelfragmente
Root fragments
Fragments de racines
Fragmentos de raíces

36.175
Wurzelfragmente
Root fragments
Fragments de racines
Fragmentos de raíces

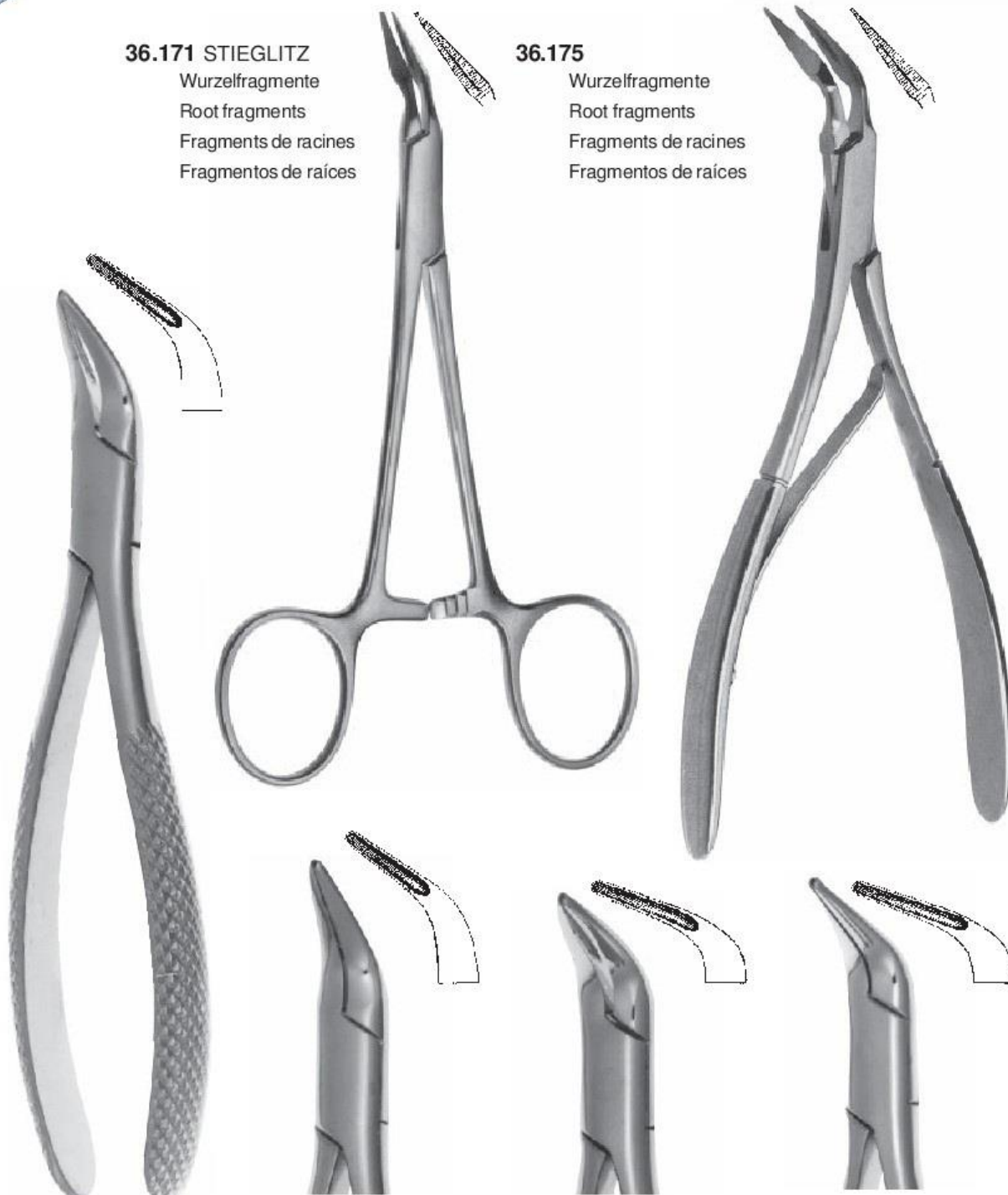

36

36.166 WITZEL
36.166-300 WITZEL
obere Wurzeln
upper roots
racines supérieures
raíces superiores

36.169
obere Wurzeln
upper roots
racines supérieures
raíces superiores

36.164 WITZEL
36.164-300 WITZEL
untere Wurzeln
lower roots
racines inférieures
raíces inferiores

36.168
untere Wurzeln
lower roots
racines inférieures
raíces inferiores

36.200-1K FIG. 37



51- 52, 61-62

36.200-18BK FIG. 39

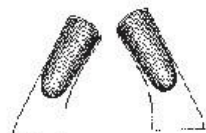

54 - 55, 64 - 65

Kinder
Children
Enfants
Niños

36.200-17K



54-55 64-65

36.200-18K

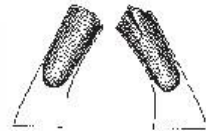

36

36.200-30K FIG. 159



53, 63

Wurzeln·roots
racines·raíces

36.200-51K



Wurzeln·roots
racines·raíces

Kinder
Children
Enfants
Niños



36

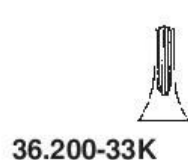
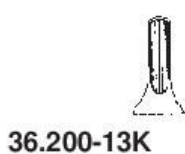

Kinder
Children
Enfants
Niños

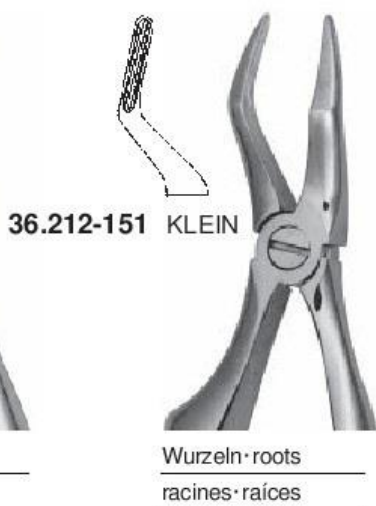
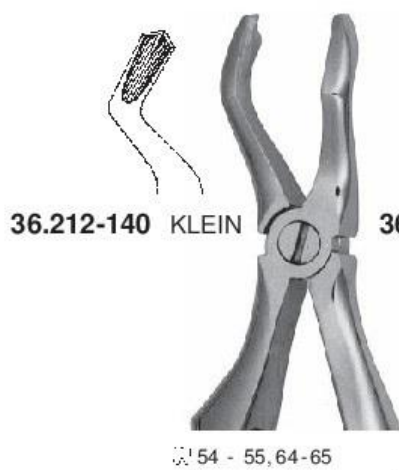

36



Amerikanische Form
American pattern
Modèle américain
Modelo americano

36



36.250-65

11 - 12, 21 - 22
Wurzeln·roots
racines·raíces



36.250-150 CRYER
Universal

11-15, 21-25



36.250-32 PARMLY

14 -17, 24 -27

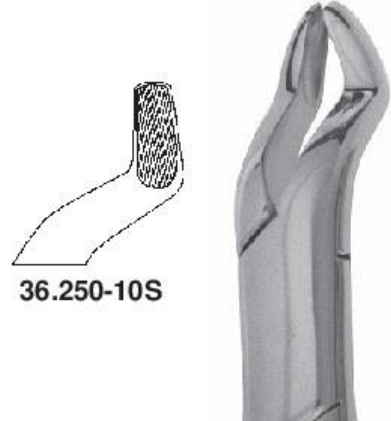

36.250-10S

16-17, 26 -27

Amerikanische Form
American pattern
Modèle américain
Modelo americano

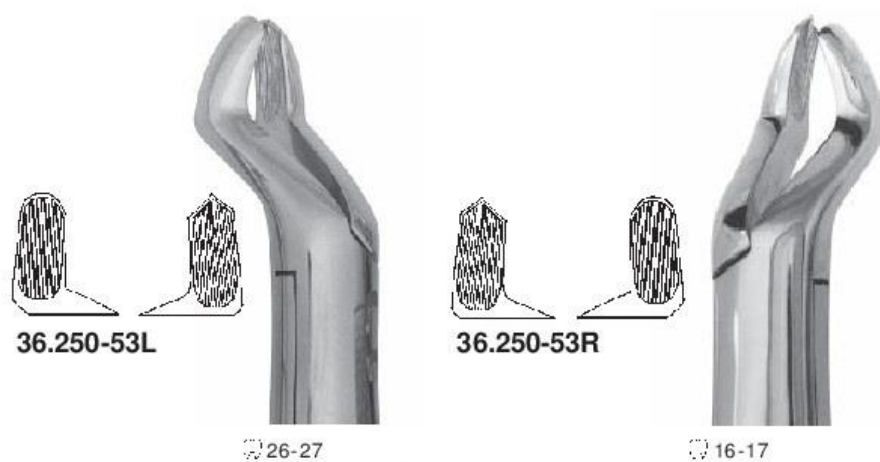

36



Amerikanische Form
American pattern
Modèle américain
Modelo americano



36.250-151
CRYER
Universal

31-35, 41-45

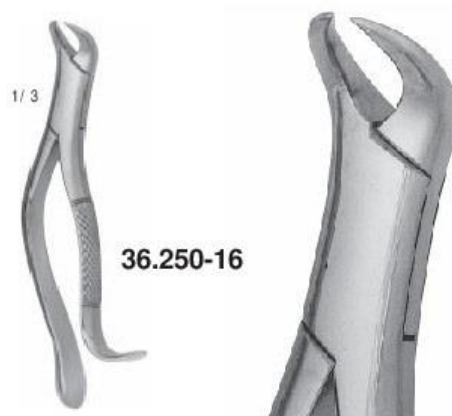

36.250-16

36-37, 46-47



36.250-17

36-37, 46-47



36.250-23

36-37, 46-47



36.250-203

31-35, 41-45



36.250-222

38, 48

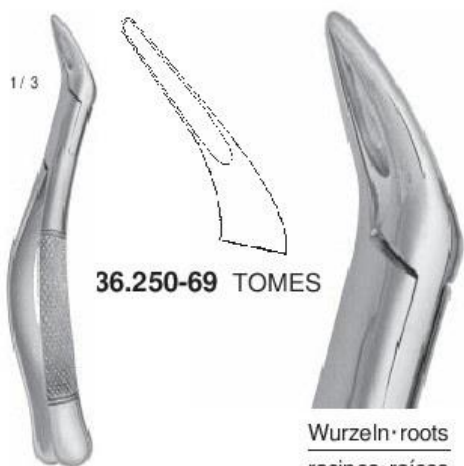

1/3
36.250-69 TOMES

Wurzeln·roots
racines·raíces



36.250-62 UNIVERSAL

11-12, 21-22
51-55, 61-65
Wurzeln·roots
racines·raíces

Amerikanische Form
American pattern
Modèle américain
Modelo americano



36.250-150S

Kinder
Children
Enfants
Niños



51- 55, 61-65



36.250-151S

Kinder
Children
Enfants
Niños



71- 75, 81-85

Hohlmeisselzangen
Rongeur forceps
Pincers gouges
Pinzas gubias

36.431-20 MINI-FRIEDMANN
15,5 cm



36.431-21 MINI-FRIEDMANN
15 cm, S - Form



36.431-10 MINI-FRIEDMANN
14,5 cm



36.431 FRIEDMANN
14 cm

36

Hohlmeisselzangen
Rongeur forceps
Pinces gouges
Pinzas gubias



36.432 LUER-FRIEDMANN

16 cm



36.433 LUER

16 cm



36.436-1 LUER

17cm

Hohlmeisselzangen
Rongeur forceps
Pinces gouges
Pinzas gubias

36



36.451 BLUMENTHAL
45°, 14,5 cm



36.441 FIG. 3
14,5 cm



36.514 FIG. 5
16,5 cm

Hohlmeisselzangen
Rongeur forceps
Pincès gorges
Pinzas gubias



36.500 BÖHLER
16,5 cm



36.503 BEYER
18 cm

- ▶ Sehr graziler Wurzelheber für feinfühliges Arbeiten
- ▶ Very delicate elevator for gentle working
- ▶ Elévateur très gracile pour un travail délicat
- ▶ Elevador muy grácil para un trabajo suave

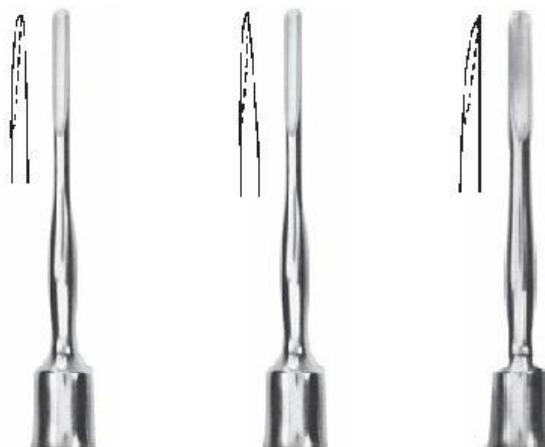

36.610-2 LUXATOR	36.610-3 LUXATOR	36.610-4 LUXATOR
2,5 mm, sehr fein	3,5 mm, sehr fein	4,5 mm, sehr fein
2,5 mm, very delicate	3,5 mm, very delicate	4,5 mm, very delicate
2,5 mm, très gracile	3,5 mm, très gracile	4,5 mm, très gracile
2,5 mm, muy grácil	3,5 mm, muy grácil	4,5 mm, muy grácil

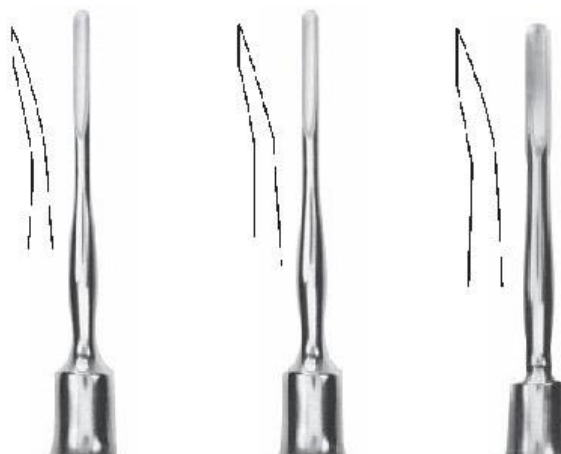

36.610-12 LUXATOR	36.610-13 LUXATOR	36.610-14 LUXATOR
2,5 mm, sehr fein	3,5 mm, sehr fein	4,5 mm, sehr fein
2,5 mm, very delicate	3,5 mm, very delicate	4,5 mm, very delicate
2,5 mm, très gracile	3,5 mm, très gracile	4,5 mm, très gracile
2,5 mm, muy grácil	3,5 mm, muy grácil	4,5 mm, muy grácil

gerade
straight
droit
recto



36.614-2 LUXATOR
2 mm



36.614-3 LUXATOR
3 mm



36.614-4 LUXATOR
4 mm



36.614-5 LUXATOR
5 mm



36

gebogen
curved
courbé
curva



36.614-12 LUXATOR
2 mm



36.614-13 LUXATOR
3 mm



36.614-14 LUXATOR
4 mm



36.614-15 LUXATOR
5 mm



36.620-23 BEIN
3 mm



36.620-2 BEIN
2 mm



36.620-3 BEIN
3 mm



36.620-4 BEIN
4 mm

36



36.634-4 FIG. 301
2,5 mm



36.634-3 FIG. 46
3 mm



36.634-2 FIG. 34S
4 mm



36.634-1 FIG. 34
5 mm



36.636-1



36.636-2



36.636-3



36.636-4



36.636-5



36.636-6



36.646-1 COUPLAND
3 mm



36.646-2 COUPLAND
3,8 mm



36.646-3 COUPLAND
4,6 mm



36.640-1 HYLIN



36.640-2 HYLIN



36.642 FIG. 3

36



FLOHR



36.782-5 FLOHR

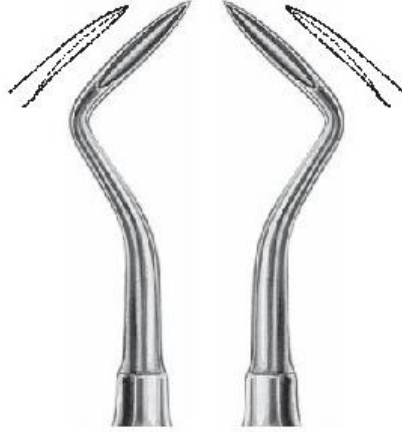

36.782-12 FLOHR 36.782-13 FLOHR



36.782-2 FLOHR 36.782-3 FLOHR



36.782-14 FLOHR



36.782-15 FLOHR



36.790-12 APICAL



36.790-13 APICAL



36.790-1 APICAL



36.790-5 APICAL



APICAL



36.1490-1 CHOMPRET
Syndesmotome
Syndesmotomes
Sindesmotomes
Sindesmotomos



36.1490-2



36.1490-3

36



36.1491-2 massiv
Syndesmotome
Syndesmotomes
Sindesmotomes
Sindesmotomos



36.1491-12 SYNDESMOTOME
fein gezahnt, massiv
fine serrated, massive
denté fin, massif
dentado fino, masivo



36.648-1



36.648-2



36.648-3



36.648-11



36.648-12



36.648-13



LINDO-LEVIEN

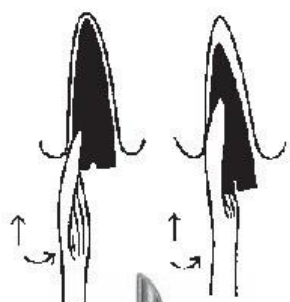

36.710-1 KOPP



36.710-2 KOPP



36.710-3 KOPP



36.710-4 KOPP

36



KOPP



KOPP



36.710-11 KOPP



36.710-12 KOPP



36.710-13 KOPP



36.710-14 KOPP



36.723 COLEMAN



36.726-1 LONDON HOS PITAL 36.726-2



36.804-1 WARWICK-JAMES

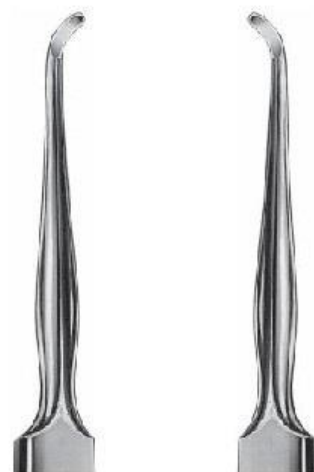

36.804-2 WARWICK-JAMES 36.804-3



36.838-1 SELDIN **36.838-2 SELDIN**
 6+7, Fig. 1L 6+7, Fig. 1R

36



36.830-1 CRYER



36.830-2 CRYER



36.835-1 CRYER



36.835-2 CRYER



36.836-27 CRYER



36.836-28 CRYER



2/3
36.684 LECLUSE



36.840-321 BARRY

36.840-320 BARRY

36



36.850-13 WINTER

Fig. 12R



36.850-12 WINTER

Fig. 12L



36.850-14 WINTER

Fig. 14L



36.850-15 WINTER

Fig. 14R

Krallenheber
Claw elevators
Elévateurs à griffes
Elevadores de garra



36.920-2 POTT



36.920-1 POTT



36.760-1

für Molaren-Wurzeln
for molar roots
pour racines de molaires
para raíces de molares

36.760-2

36

nur für Wurzelfragmente
for root fragments only
seulement pour des fragments
solamente para fragmentos

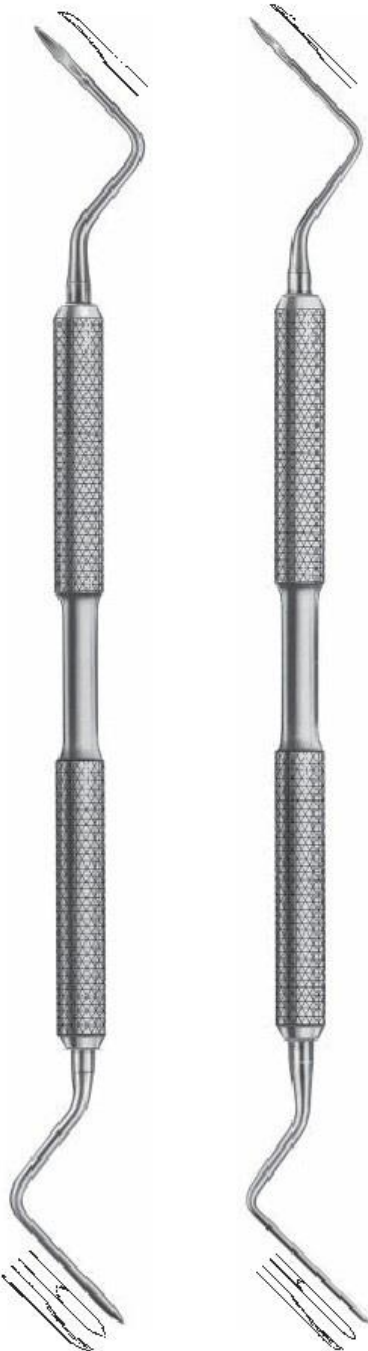

36.810

36.811



36.814-1 HEIDBRINK



36.814-3 HEIDBRINK



36.814-4 HEIDBRINK

36

Drehmeissel
Chisels
Ciseaux-burins
Cinceles

gerade / straight / droit / recto / retto, 13 cm

36.925-2 2 mm

36.925-3 3 mm

36.925-4 4 mm



bajonett / bayonet / baïonnette / bayoneta / baionetta, 13 cm

36.926-2 2 mm

36.926-3 3 mm

36.926-4 4 mm



36

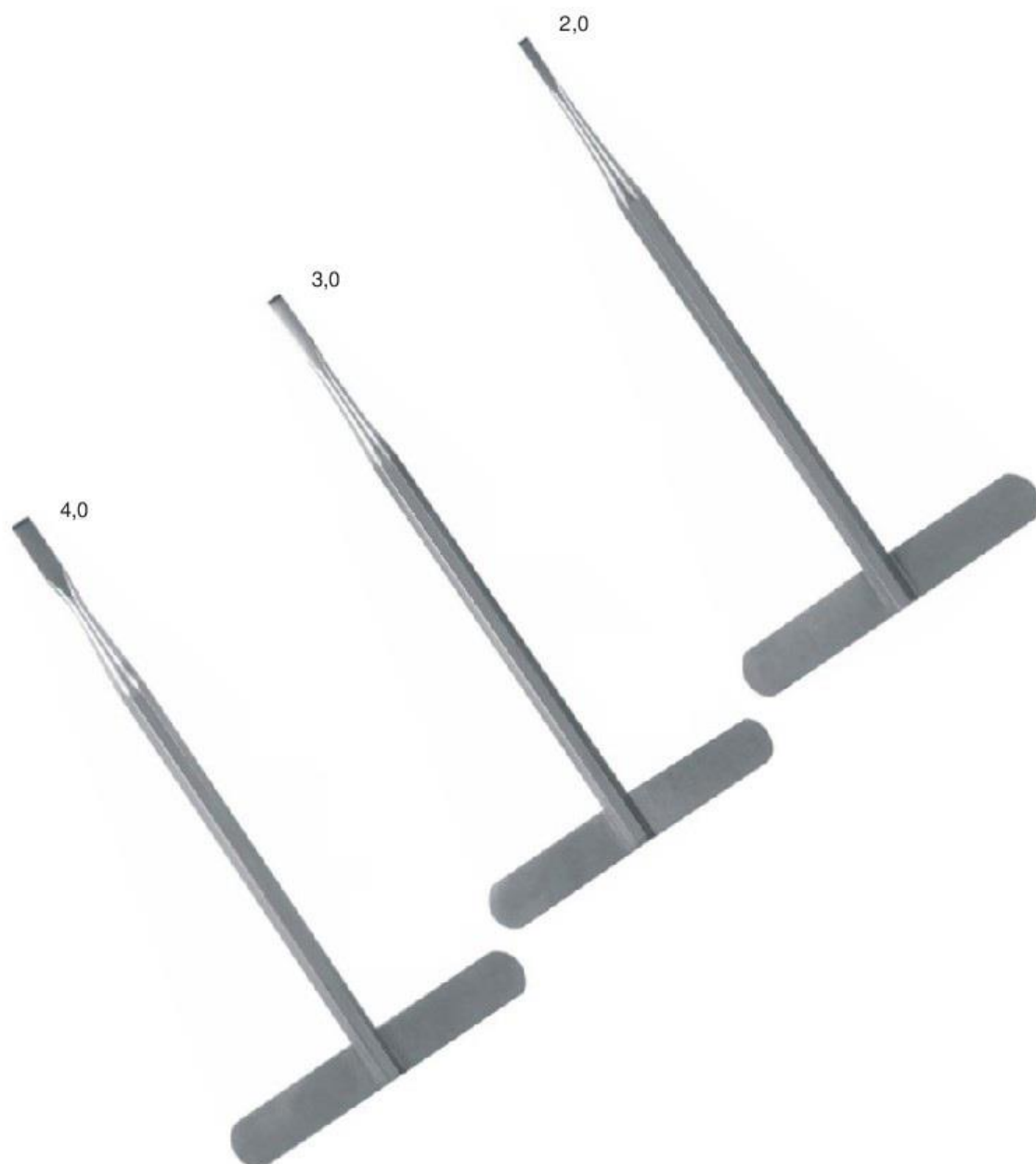



37

SURGERY
CHIRURGIE
CHIRURGIE
CIRUGÍA

37.1070-61 - 69

Mini-Klingen steril / P. zu 10 Stück
Mini blades sterile / P. of 10 pieces
Mini lames stérile / P. de 10 pièces
Mini hojas estériles / P. de 10 piezas

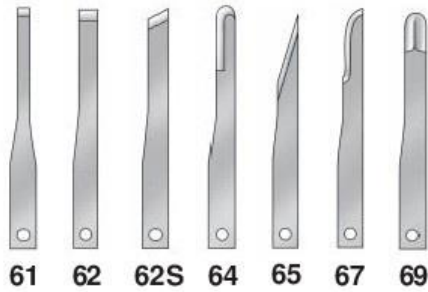

61 62 62S 64 65 67 69



37.1071-10 10 cm

37.1071-13 13 cm

37.1071-15 15 cm

Halter für Mini-Klingen
Holder for Mini blades
Manche pour Mini lames
Mango para Mini hojas

37.1035

Rasierklingenthalter
Razor blade holder
Porte lames à rasoir
Mango para hojas de afeitar



Skalpellklingen
Scalpel blades
Lames de bistouris
Hojas de bisturías

	unsteril non-sterile non-stérile no estériles	steril sterile stérile estériles
Fig. 10	37.1053-10	37.1063-10
Fig. 11	37.1053-11	37.1063-11
Fig. 12	37.1053-12	37.1063-12
Fig. 12d	37.1053-12D	37.1063-12D
Fig. 13	37.1053-13	37.1063-13
Fig. 15	37.1053-15	37.1063-15
Fig. 15c	37.1053-15C	37.1063-15C



Skalpellgriffe
Scalpel handles
Manches pour bistouris
Mangos de bisturías



37.1043 FIG. 3



37.1043-1



37.1033-1

37.1050

Klingentferner
Blade remover
Enlève-lames
Removedor de hojas



37



37.3405 BLAKE



37.1047 FIG. 7



- 37.1033-10** 1,0 mm
- 37.1033-15** 1,5 mm
- 37.1033-20** 2,0 mm
- 37.1033-25** 2,5 mm
- 37.1033-30** 3,0 mm

Parallelklingen-Skalpellgriff
Parallel blade scalpel handle
Lames parallèles-manches pour bistouris
Hojas paralelas-mangos de bisturíes

- ▶ Extrem leichtes Schneiden
- ▶ Kein Abrutschen des Zahnfleisches
- ▶ Verringertes Trauma

- ▶ Extremely easy cutting
- ▶ No tissue slippage
- ▶ Reduced trauma

- ▶ Une coupe très facile
- ▶ Pas de glissement du tissu
- ▶ Réduction du traum

- ▶ Corta muy facil
- ▶ Tejido no se desliza
- ▶ Trauma reducido

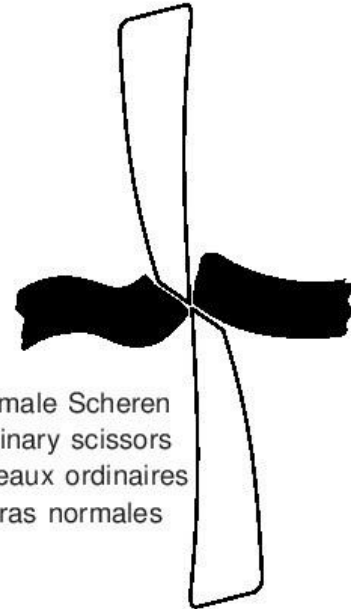

Normale Scheren
Ordinary scissors
Ciseaux ordinaires
Tijeras normales

37

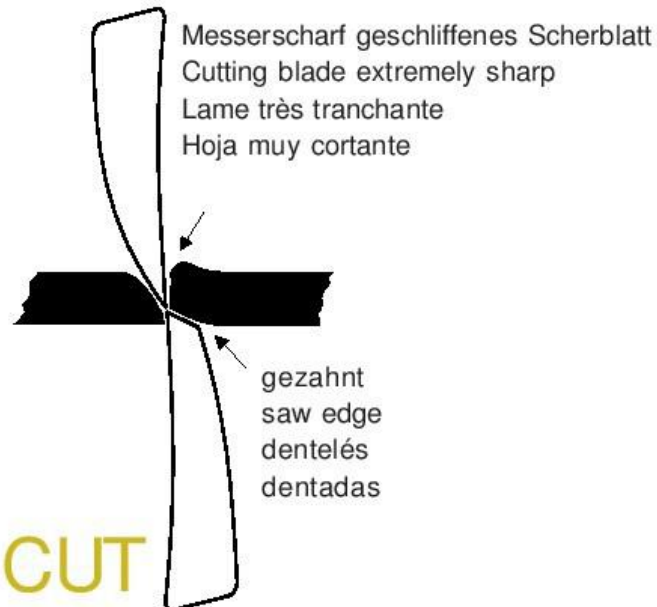

Messerscharf geschliffenes Scherblatt
Cutting blade extremely sharp
Lame très tranchante
Hoja muy cortante

gezahnt
saw edge
dentelés
dentadas

SUPER CUT



37.1110-400 SUPER CUT
11,5 cm



37.1111-400
11,5 cm



37.1143-400 KELLY
16 cm



37.1133-400 LA GRANGE
11,5 cm



37.1117-400 GOLDMANN-FOX
13 cm



37.1108

11,5 cm, schlank
11,5 cm, slim
11,5 cm, graciles
11,5 cm, delgadas



37.1109

11,5 cm, schlank
11,5 cm, slim
11,5 cm, graciles
11,5 cm, delgadas



37.1110 STANDARD

11,5 cm

37.1110-400 SUPER CUT

37.1180 TC GOLD

Hartmetalleinsätze
Tungsten carbide inserts
Mors en tungstène
Puntas de tungsteno



37.1111 STANDARD

11,5 cm

37.1111-400 SUPER CUT

37.1181 TC GOLD

Hartmetalleinsätze
Tungsten carbide inserts
Mors en tungstène
Puntas de tungsteno

37



37.1113

11,5 cm



37.1114

11,5 cm



37.1115

11,5 cm



37.1119 STEVENS

11,5 cm



37.1135-1 NOYES
11,5 cm

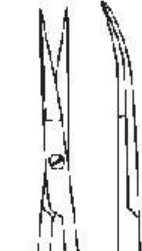
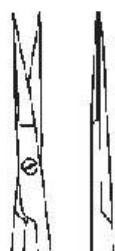

37.1136-1 NOYES
11,5 cm



37.1135-15 MICRO
15 cm



37.1136-15 MICRO
15 cm

37



37.1133 LA GRANGE
11,5 cm, gezahnt
11,5 cm, saw edge
11,5 cm, dentelés
11,5 cm, dentadas

37.1133-400 SUPER CUT



37.1120
12 cm



37.1121
12 cm



37.1129 WAGNER
12 cm, gezahnt
12 cm, saw edge
12 cm, dentelés
12 cm, dentadas



37.1131 QUINBY
12,5 cm



37.1116 GOLDMANN-FOX
13 cm, gezahnt, gerade
13 cm, saw edge, straight
13 cm, dentelés, droits
13 cm, dentadas, rectas



37.1117 GOLDMANN-FOX
13 cm, gezahnt, gebogen
13 cm, saw edge, curved
13 cm, dentelés, courbés
13 cm, dentadas, curvas



37.1117-400 SUPER CUT

37.1185 GOLDMANN-FOX TC GOLD
Hartmetalleinsätze
Tungsten carbide inserts
Mors en tungstène
Puntas de tungsteno



37.1117-1 GOLDMANN-FOX
13 cm, gezahnt, S-gebogen
13 cm, saw edge, S-curved
13 cm, dentelés, S-courbés
13 cm, dentadas, curvatura S

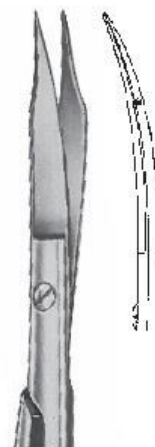

37



2/3

37.1124 JOSEPH
14 cm



37.1125 JOSEPH
14 cm



2/3

37.1152 LOCKLIN
16 cm



2/3

37.1142 KELLY
16 cm

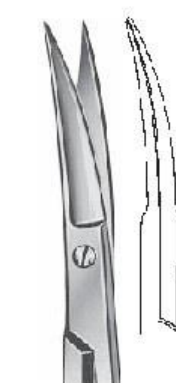

37.1143 KELLY
16 cm

37.1143-400 SUPER CUT



2/3

37.1147-1 DEAN
17,5 cm, gezahnt
17,5 cm, saw edge
17,5 cm, dentelés
17,5 cm, dentadas



Ligaturscheren
Ligature scissors
Ciseaux à ligatures
Tijeras para ligaduras



37.1168-11 SPENCER

11 cm



37.1168-200 SPENCER

11 cm



37.1168 SPENCER

9 cm



37.1169 LITTAUER

12,5 cm



37.1169-200 NORTHBENT

12,5 cm





37.1139-18 METZENBAUM
18 cm

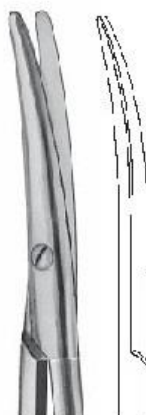

37.1139-14 METZENBAUM
14 cm

37

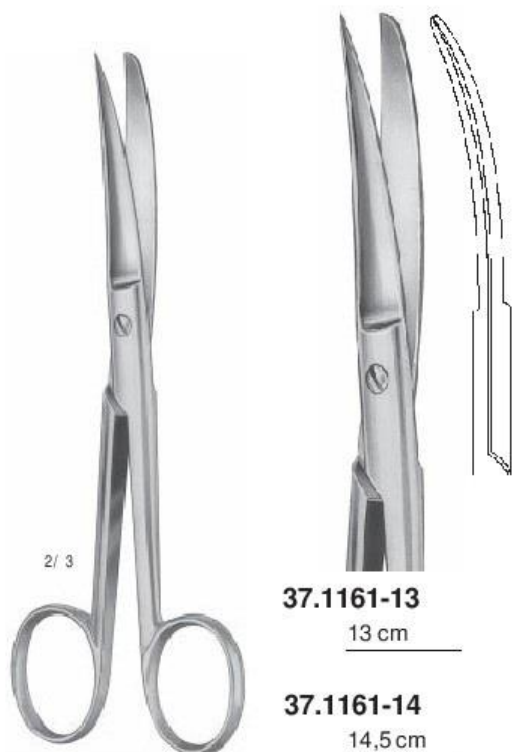

37.1161-13
13 cm

37.1161-14
14,5 cm

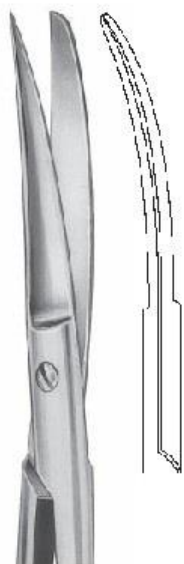

37.1162-13
13 cm

37.1162-14
14,5 cm



37.1163-13
13 cm

37.1163-14
14,5 cm



37.1207 ADSON

12 cm



37.1207-115 MICRO-ADSON

15 cm, sehr fein
15 cm, very fine
15 cm, très fine
15 cm, muy finas

37.1220-12 ADSON TC GOLD

12 cm, Hartmetalleinsätze
12 cm, tungsten carbide inserts
12 cm, mors en tungstène
12 cm, puntas de tungsteno



37.1220-15 ADSON TC GOLD

15 cm, Hartmetalleinsätze
15 cm, tungsten carbide inserts
15 cm, mors en tungstène
15 cm, puntas de tungsteno



2/3

2/3

37



37.1197-13 SEMKEN

13 cm

37.1197-15 SEMKEN

15 cm



37.1201-13

13 cm

37.1201-14

14 cm



37.1205-13

13 cm

37.1205-14

14 cm

37.1205-162

16 cm, kreuzgeriefte Arbeitsenden
16 cm, cross-serrated tips
16 cm, pointes quadrillés
16 cm, puntas con forma de diamante



37



37.1223-15 DEBAKEY
15 cm



37.1224-15 DEBAKEY
15 cm



37.1210 TAYLOR
18 cm



37.1213 CUSHING
18 cm



37.2110
Nahtpinzette
Suture forceps
Pince à suture
Pinzas para sutura



2/3

37.1208 ADSON
12 cm



1x2



2/3

37.1208-115 MICRO-ADSON
15 cm, sehr fein
15 cm, very fine
15 cm, très fine
15 cm, muy finas



1x2



37.1208-215 MICRO-ADSON
15 cm, sehr fein
15 cm, very fine
15 cm, très fine
15 cm, muy finas

1x2



1x2

37.1198-13 SEMKEN
13 cm

37.1198-15 SEMKEN
15 cm



1x2

37.1198-131 SEMKEN
13 cm

37.1198-151 SEMKEN
15 cm



1x2

37.1202-13
13 cm

37.1202-14
14 cm



1x2

37.1206-13
13 cm

37.1206-14
14 cm



37.1218 GILLIES
16 cm

1x2



1x2



1x2



37.1214-1 MICRO CUSHING

18 cm, sehr fein
18 cm, very fine
18 cm, très fine
18 cm, muy finas



37

37.1212 TAYLOR 18 cm **37.1214 CUSHIN** 18 cm

37.1222-1 FOX Gewebepinzette, 15,5 cm
Gum seizing forceps, 15,5 cm
Pince à gencive, 15,5 cm
Pinzas para gingiva, 15,5 cm

37.1222 FOX mit Schloß
with lock
avec arrêt
con cerradura

37.3426-1 CRANE-KAPLAN Taschenmarkierungspinzetten
Pocket markers
Pincas à marquer la poche

37.3426-2 Pinzas para marcar el sulco periodontal con cerradura, 20 cm

37.1221-20 mit Schloß, 20 cm
with lock, 20 cm
avec arrêt, 20 cm

Arterienklemmen
Haemostatic forceps
Pinces hémostatiques
Pinzas hemostáticas

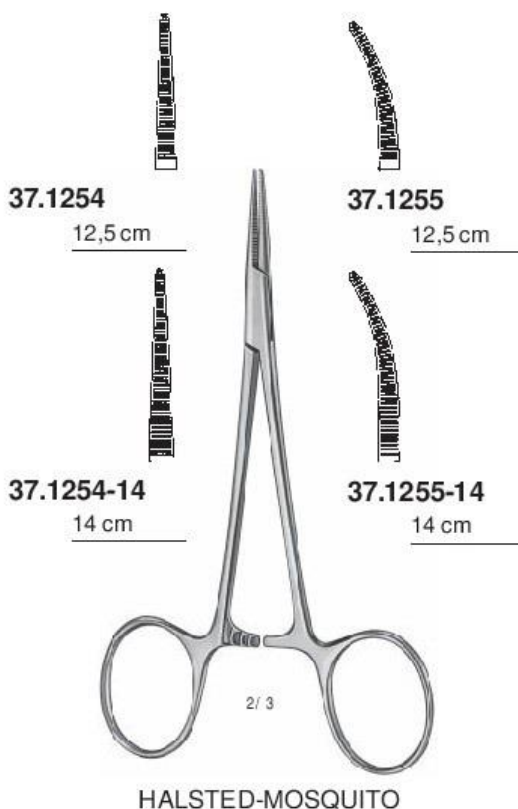

37





37.1284-9 BACKHAUS

9 cm, Tuchklemme
9 cm, towel clip
9 cm, pince à champs
9 cm, pinza de campo



37.1280 JONES

8,5 cm, Tuchklemme
8,5 cm, towel clip
8,5 cm, pince à champs
8,5 cm, pinza de campo

37.1284-11 BACKHAUS

11 cm, Tuchklemme
11 cm, towel clip
11 cm, pince à champs
11 cm, pinza de campo

37



37.1264 ALLIS

15,5 cm, Zahnfleischfaßzange
15,5 cm, gum seizing forceps
15,5 cm, pince à gencive
15,5 cm, pinze para filar la encía



37.1290-20 GROSS

20 cm, Kornzange
20 cm, dressing forceps
20 cm, pince à pansement
20 cm, pinza para curaciones

37.1291-20 GROSS

20 cm, Kornzange
20 cm, dressing forceps
20 cm, pince à pansement
20 cm, pinza para curaciones



2/3

UFFENORDE



37.1308-2

17 cm



37.1308-3

17 cm



2/3

VOLKMANN

17 cm



37.1306-30

Fig. 000



37.1306-40

Fig. 0000

37



2/3

37.1340 MARTINI

15 cm



2/3

37.1342 WILLIGER

15 cm



2/3

37.1342-OR

15 cm



2/3

37.1354

16 cm

37

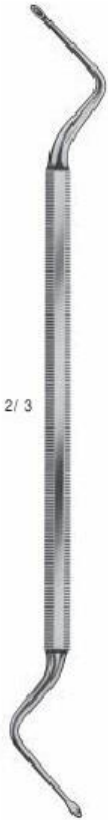

2 / 3

HEMINGWAY

17 cm



37.1361-0



37.1361-1



37.1361-2



37.1361-3



2 / 3

HEMINGWAY

17 cm



37.1365-0



37.1365-1



37.1365-2



37.1365-3



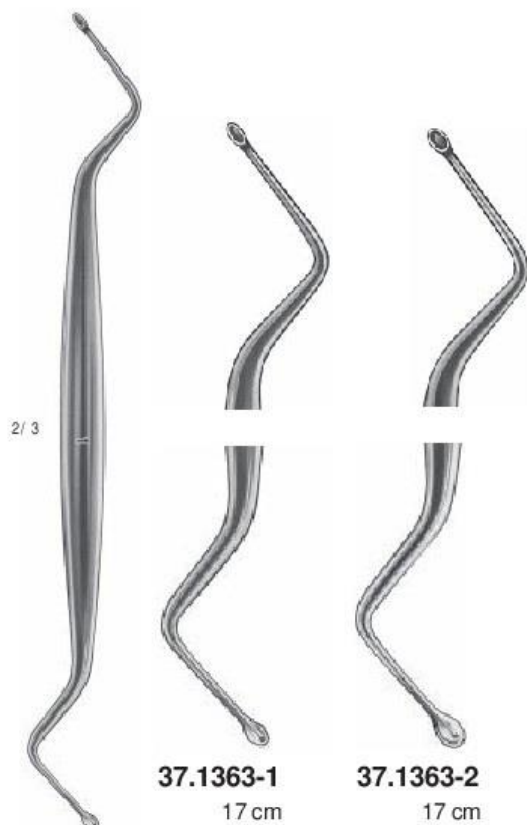
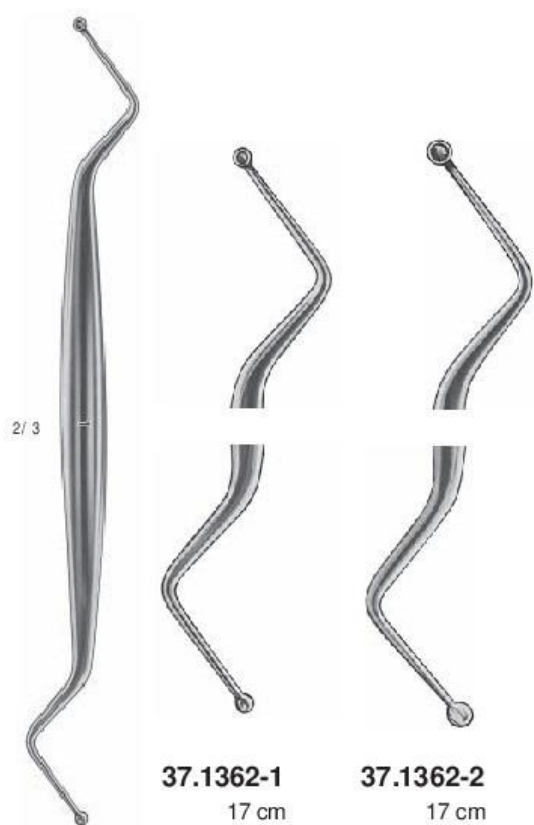

37

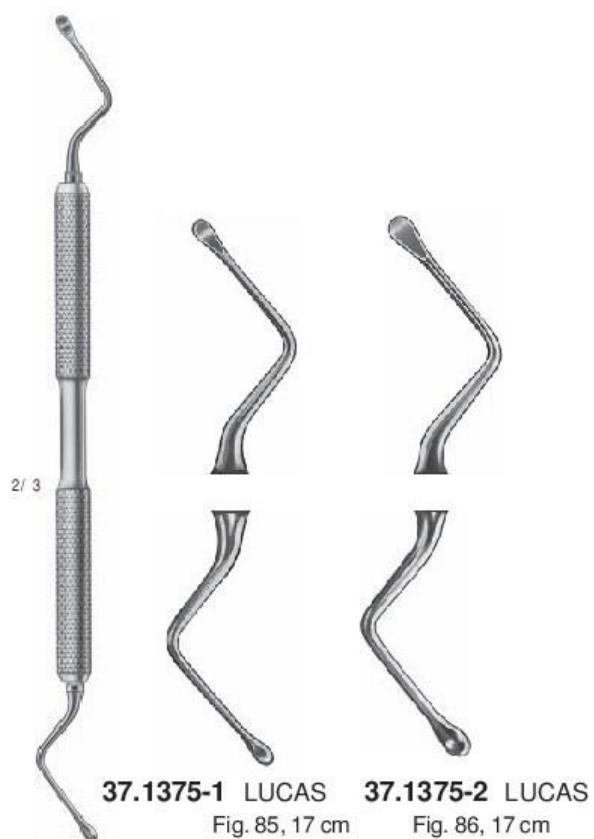
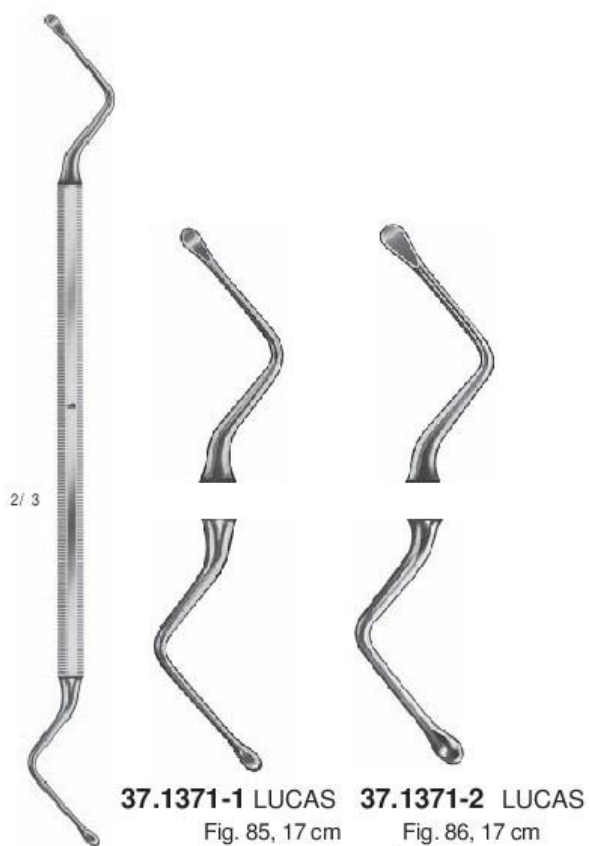

Raspatorien
Raspatories
Rugines-raspatoires
Periostótomos

37.1413-1 6 mm
37.1413-2 7 mm
37.1413-3 9 mm
37.1413-4 11 mm

37

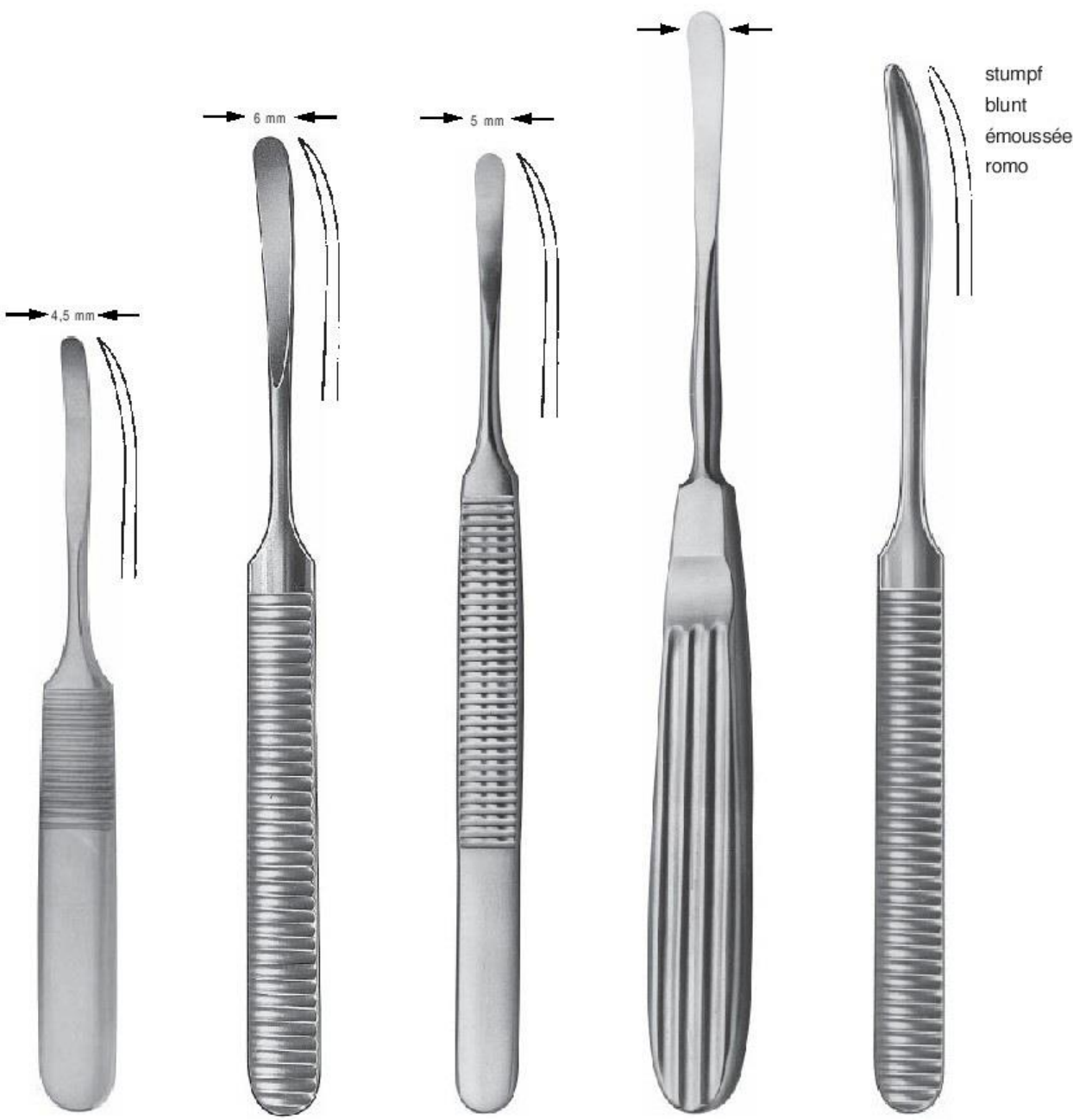

stumpf
blunt
émoussée
romo

37.1415 WILLIGER
12,5 cm

37.1416 WILLIGER
16 cm

37.1417 KÖNIG
15,5 cm

OBWEGESER
17,5 cm

37.1420 WILLIGER
17 cm

Raspatorien
Raspatories
Rugines-raspatoires
Periostótomos

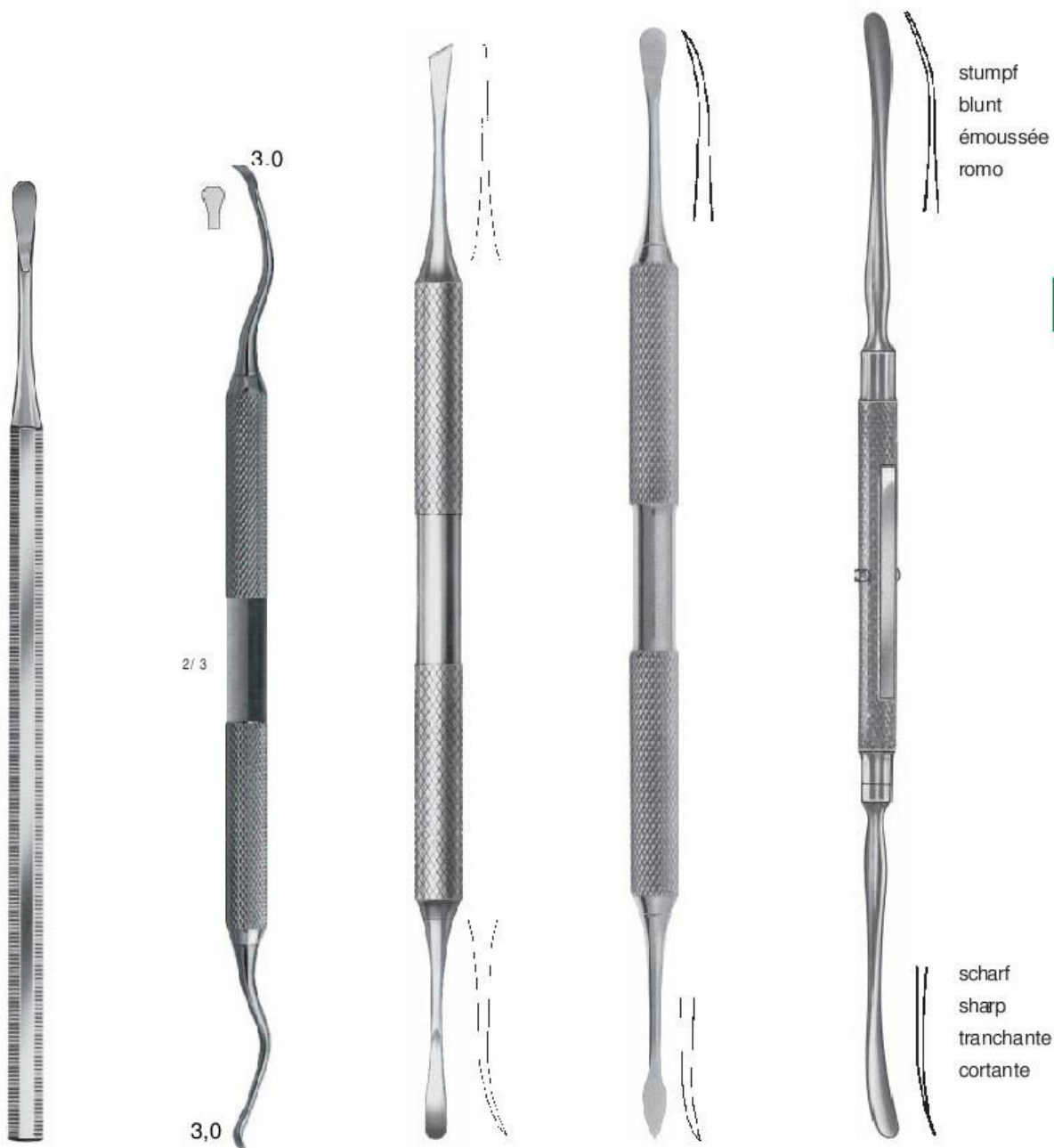

37

37.1376 PARTSCH
15 cm

37.1378

37.1401-1

37.1409

37.1408 FREER

Raspatorien
Raspatories
Rugines-raspatoires
Periostótomos

37



37.1407-24 MOLT
Fig. 2/4



37.1400 MOLT
Fig. 9



37.1406 FOX



37.1407 MOLT



37.1393 SELDIN
Fig. 23, 19 cm

Raspatorien
Raspatoires
Rugines-raspatoires
Periostótomos



37.1405 PRICHARD



37.1401 WEST



37.1412-1 FREER
scharf
sharp
tranchante
cortante



37.1412-22 FREER
stumpf
blunt
émoussée
romo

37.1412-21 FREER
stumpf
blunt
émoussée
romo

Knochenfeilen Chirurgische Küretten
Bone files Surgical curettes
Râpes à os Curettes à chirurgie
Limas de hueso Curetas para cirugía

37



MILLER-COLBURN
17 cm, Knochenfeilen
17 cm, bone files
17 cm, râpes à os
17 cm, limas de hueso



37.3385-1 KRAMER 37.3385-2 KRAMER 37.3385-3 KRAMER

Meißel
Chisels
Burins
Cinceles



37.1650-1 OCHSENBEIN
16 cm



37.1650-2



37.1650-3 OCHSENBEIN
#3



37.1650-4 OCHSENBEIN
#4



37.1650-36 RHODES

37

Meißel
Chisels
Burins
Cinceles

37

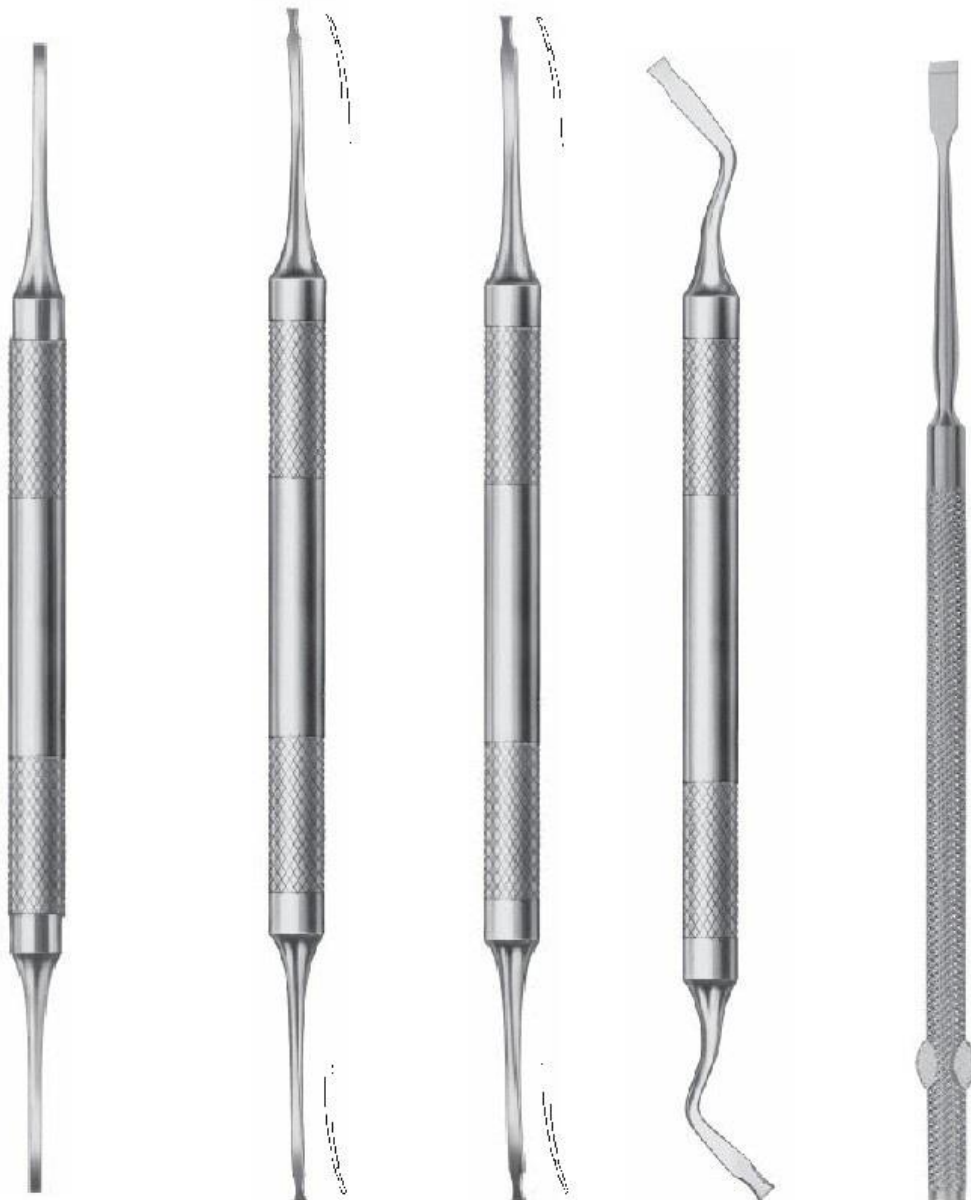

37.1650-12 KRAMER-NEVINS

37.1651-1 FEDI

37.1651-2 FEDI

37.1651-3 FEDI

37.1674-4 FREER

16 cm, 4 mm

Meißel
Chisels
Burins
Cinceles

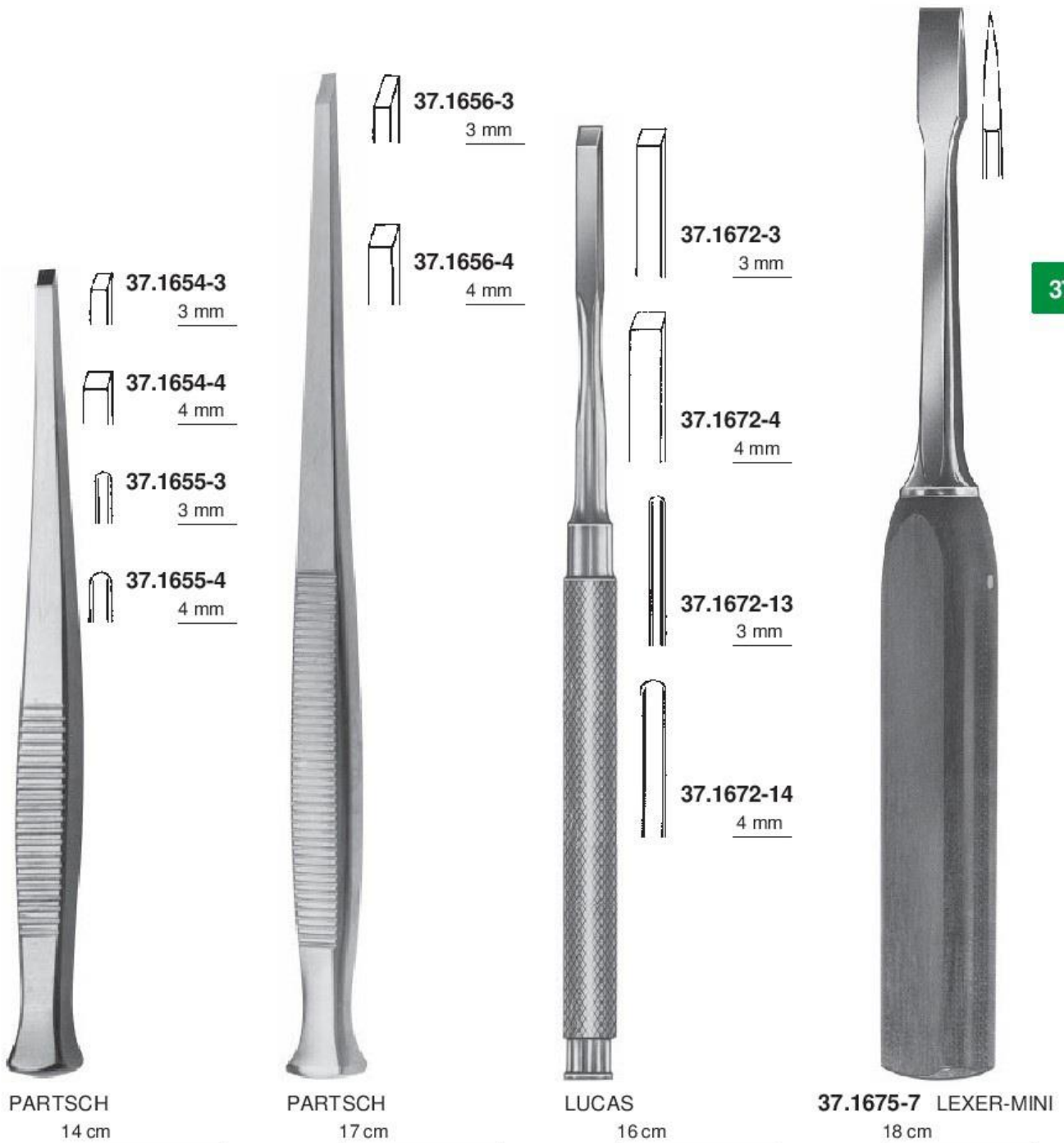

Meißel
Chisels
Burins
Cinceles



37

37.1682-4 EPKER 4 mm
37.1682-6 EPKER 6 mm
37.1682-8 EPKER 8 mm
 18 cm, gerade
 18 cm, straight
 18 cm, droit
 18 cm, recto

37.1682-16 EPKER 6 mm
37.1682-18 EPKER 8 mm
 18 cm, leicht gebogen
 18 cm, slightly curved
 18 cm, courbé légèrement
 18 cm, curvado levemente

37.1682-26 EPKER 6 mm
37.1682-28 EPKER 8 mm
 18 cm, stark gebogen
 18 cm, strong curved
 18 cm, courbé légèrement
 18 cm, curvo



1/2

37.1620 WILLIGER

21 cm, 230 g, bleigefüllt
21 cm, 230 g, lead filled
21 cm, 230 g, garni de plomb
21 cm, 230 g, relleno de plomo

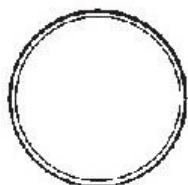

1/2

37.1621 WILLIGER

21 cm, 200 g, rostfreier Stahl
21 cm, 200 g, stainless steel
21 cm, 200 g, acier inoxydable
21 cm, 200 g, acero inoxidable

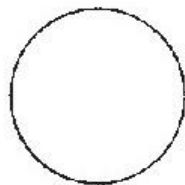

1/2

37.1626

19 cm, 200 g, bleigefüllt
19 cm, 200 g, lead filled
19 cm, 200 g, garni de plomb
19 cm, 200 g, relleno de plomo



Bis 140°C sterilisierbar
Sterilisation up to 140°C
Stérilisables jusqu'à 140°C
Esterilización hasta 140°C

37



1/2

auswechselbare Kunststoffeinsätze
interchangeable plastic inserts
interchangeables en matière plastique
tapas de plástico intercambiables

37.1632 MEAD

19 cm, 320 g
19 cm, 320 g
19 cm, 320 g
19 cm, 320 g

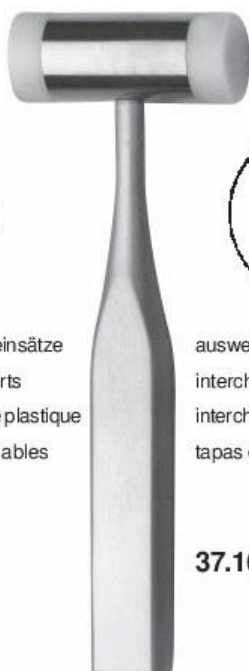
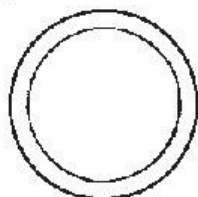

1/2

auswechselbare Kunststoffeinsätze
interchangeable plastic inserts
interchangeables en matière plastique
tapas de plástico intercambiables

37.1637

18,5 cm, 220 g
18,5 cm, 220 g
18,5 cm, 220 g
18,5 cm, 220 g

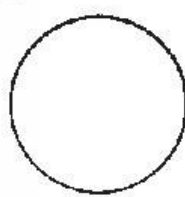

1/2

37.3740

19 cm, 180 g, bleigefüllt
19 cm, 180 g, lead filled
19 cm, 180 g, rempli de plomb
19 cm, 180 g, relleno de plomo

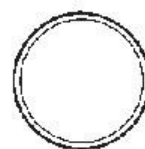

Periotome
Periotomes
Périotomes
Periótomos

Zur atraumatischen Trennung der Scharpey'schen Fasern im PA-Spalt zur schonenden Extraktion.

The specific instrument for atraumatic teeth extraction before implants are placed. No cortical bone damage with this instrument, it cuts the periodontal ligament carefully and easily.

37



37.1706-1



37.1706-2



Sinus Lift Küretten, stumpf
Sinus Lift Curette, blunt
Curette pour sinus lift, émoussée
Cureta para senos lift, romo

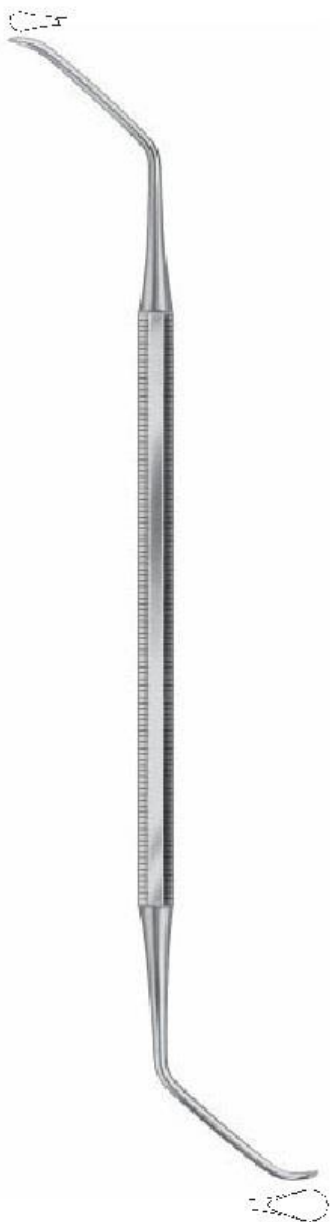

37.1430-1

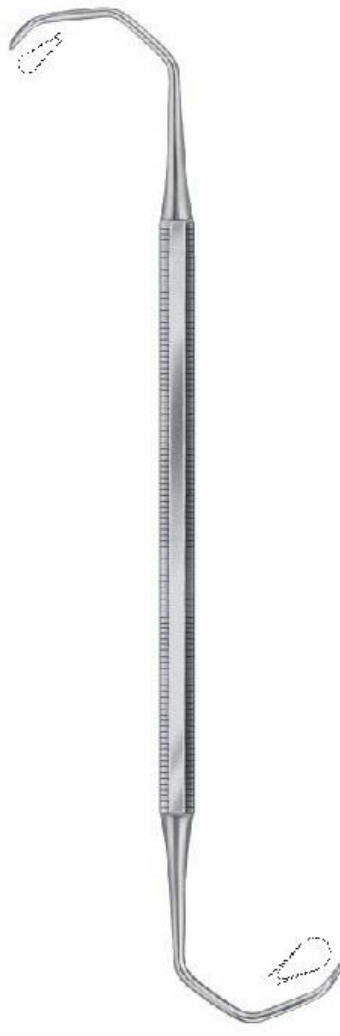

37.1430-2



37.1430-3

2,2

2,8

3,4

4,0

Knochenerweiterungs-System
Bone spreading system
Système de prolongation d'os
Sistema de la extensión del hueso

37.1710-22

37.1710-28

37.1710-34

37.1710-40

37

4,0

3,4

2,8

2,2

27.1710-122

37.1710-128

37.1710-134

37.1710-140



37.1510

2,5 mm

37.1510-1

1,8 mm



37.3423

Medikamententräger
Medicine applicator
Porte-médicament
Porta-medicamentos



37.3421

Medikamententräger
Medicine applicator
Porte-médicament
Porta-medicamentos



37.1524-13

13 cm

37.1524-14

14 cm



37.1528-20

Ø 0,7 + 0,8 mm, Fig. 0-1

37

37.1528-10

Ø 0,8 + 0,9 mm, Fig. 0-1

37.1528-1

Ø 0,9 + 1,1 mm, Fig. 1-2

37.1528-2

Ø 1,1 + 1,3 mm, Fig. 2-3

37.1528-3

Ø 1,3 + 1,4 mm, Fig. 3-4

BOWMANN

13 cm, Knopfsonde
13 cm, probe
13 cm, sonde
13 cm, sonda

37



37.1863

16 cm, scharf
16 cm, sharp
16 cm, tranchant
16 cm, cortante



37.1838 KILNER
15 cm



37.1868

16 cm, stumpf
16 cm, blunt
16 cm, mousse
16 cm, romo



GILLIES
18 cm



37.1842 ROLLET

13 cm, scharf
13 cm, sharp
13 cm, tranchant
13 cm, cortante



37.1839-1



37.1839-2



37.1850 MÜLLER-SENN

16 cm, scharf
16 cm, sharp
16 cm, tranchant
16 cm, cortante



SENN-GREEN
16 cm

37.1836-1
10x6 mm

37.1836-2
20x6 mm

2 / 3



37.1835 FARABEUF

12 cm

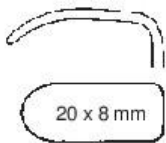

20 x 8 mm

37.1934-20

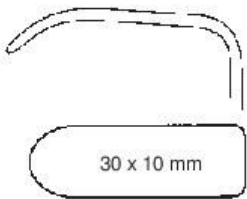

30 x 10 mm

37.1934-1

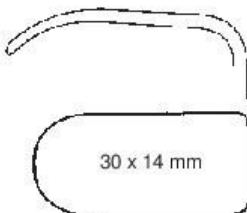

30 x 14 mm

37.1934-2

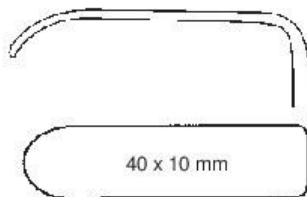

40 x 10 mm

37.1934-4

LANGENBECK

22 cm

2 / 3



37.1935 SCHÄFER

23 cm

Kombinierter Wundhaken und Wangenhalter „Schäfer“

Doppelt funktionelles Instrument zum Abhalten des Lappens und der Wange bei chirurgischen Eingriffen wie Implantation und Wurzelspitzenresektion.

37

Combined wound and cheek retractor „Schäfer“

Dual-purpose instrument for the retraction of flaps and cheek during surgery such as implantation and apicectomy.



37

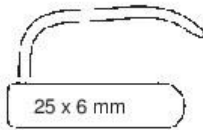

37.1940-50 KOCHER

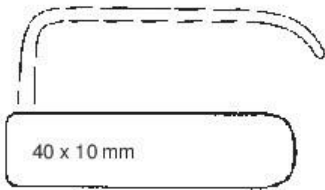

37.1940-1 KOCHER

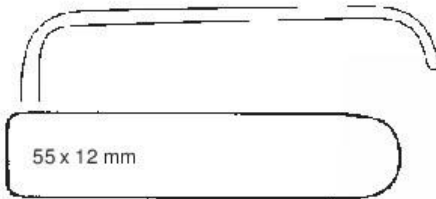

37.1940-2 KOCHER



37.1947 BOWDLER-HENRY'S
16,5 cm



37.2559-1
18 cm, Ø 2 mm

37.2559-2
18 cm, Ø 3 mm

FRAZIER
Saugkanülen
Suction tubes
Canules pour aspiration
Canulas para aspiración



37.2560 COGSWELL
Saugkanüle
Suction tube
Canule pour aspiration
Canula para aspiración

- ▶ Abhalter für gesamten Ober- bzw. Unterkiefer
- ▶ Retractors for complete upper resp. lower jaws
- ▶ Ecarteurs pour mâchoires complètes. Propre aux inférieures et supérieures
- ▶ Separadores para quijadas enteras. Propio para inferiores y superiores

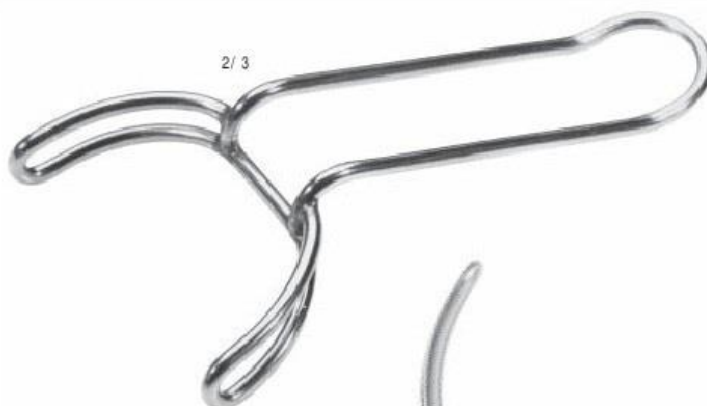

37.2510
15 cm

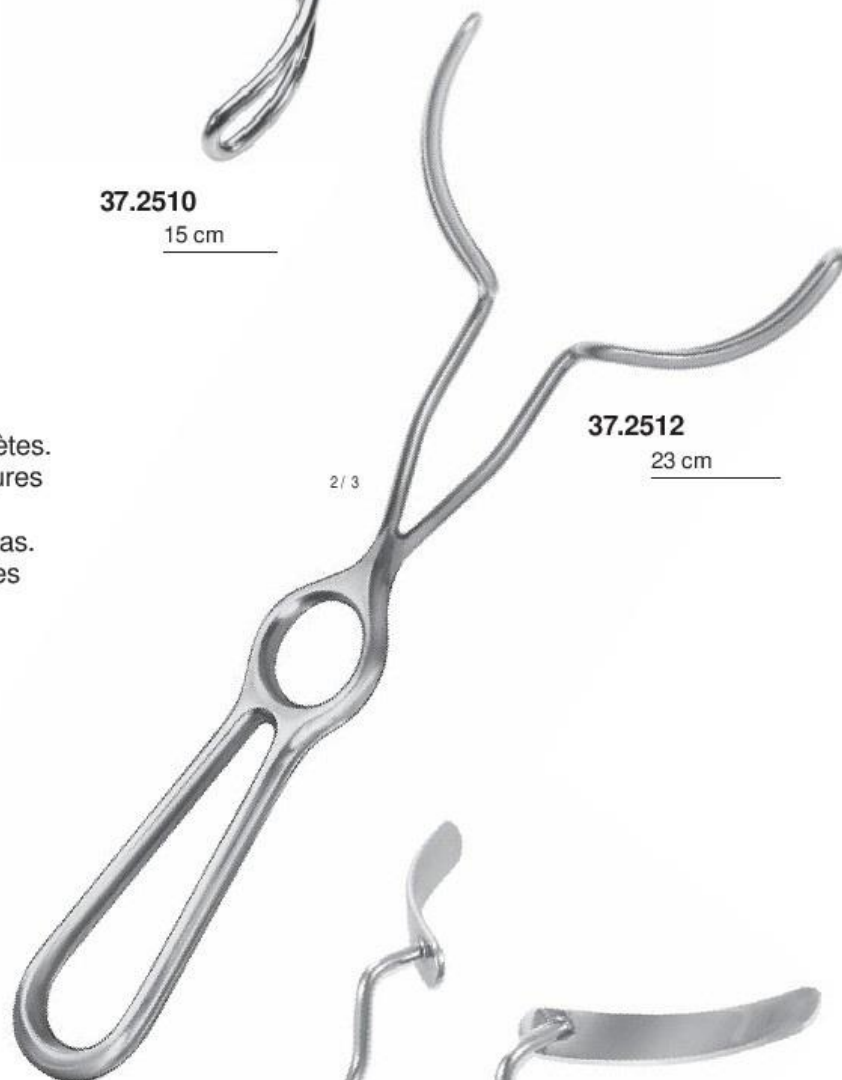

37.2512
23 cm



37.2513 MATY
17 cm



37.2502-1 MIDDELDORPF
17 mm

2 / 3



37.2502-2 MIDDELDORPF
22 mm



37.2450 HILGER

Abhalter, passend auf Mundspiegelgriffe

Retractor, fits on mouth mirror handles

Ecarteur, compatible avec manches de miroirs à bouche

Separador, compatible con mangos para espejos intraorales



2 / 3

37.2332 LANGENBECK

Fingerschützer

Finger protector

Protège-doigts

Protector de dedos

37



2 / 3

37.2460 MINNESOTA
16 cm



2 / 3

37.2462 STERNBERG
16 cm



2 / 3

37.2470 ROUX
17 cm



37.2205 DENHART
13 cm



37.2237 DOYEN-MOLT

10 cm - für Kinder, for children, pour enfants, para niños, per bambini

37.2205-1



1 Paar Silikoneinlagen
1 pair of silicone inserts
1 paire de protecteurs silicones
1 pareja de silicón capas

37.2238 DOYEN-MOLT

12 cm - für Erwachsene, for adults, pour adulte, per adulto, per adulto

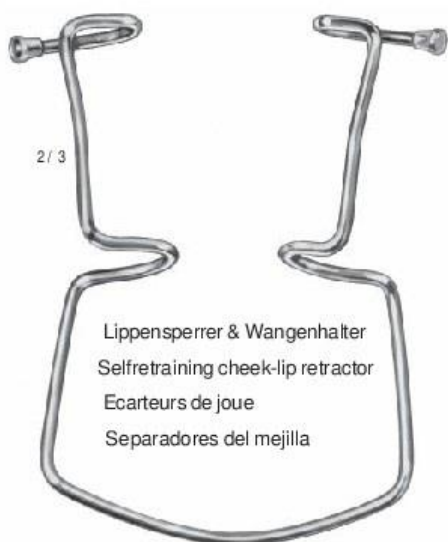

37.2465-1 ORINGER
klein, small, petit, pequeno

37.2465-2 ORINGER
mittel, medium, moyen, medio

37.2465-3 ORINGER
groß, large, grand, grande



Zungen-Drücker
Tongue depressor
Abaisse-langue
Depresor de lengua

37.2338-1 WIEDER
klein, small, petit, pequeno

37.2338-2 WIEDER
groß, large, grand, grande



37.2334 BUCHWALD
18 cm, Zungenspatel
18 cm, tongue depressor
18 cm, abaisse-langue
18 cm, abatelengua

Mundsperrer
Mouth gags
Ouvre-bouches
Abre-bocas



37.2000-1 TC GOLD 13 cm
Hartmetalleinsätze, gerade
Tungsten carbide inserts, straight
Pointes en tungstène, droites
Puntas de tungsteno, rectas

37.2000-6 TC GOLD 13 cm
Hartmetalleinsätze, gebogen
Tungsten carbide inserts, curved
Pointes en tungstène, courbées
Puntas de tungsteno, curvas

37.2000-51 TC GOLD 18 cm
Hartmetalleinsätze, gerade
Tungsten carbide inserts, straight
Pointes en tungstène, droites
Puntas de tungsteno, rectas

37.2000-56 TC GOLD 18 cm
Hartmetalleinsätze, gebogen
Tungsten carbide inserts, curved
Pointes en tungstène, courbées
Puntas de tungsteno, curvas



► **Überlegene Haltbarkeit**
durch Hartmetalleinsätze

► **Kein Drehen oder Rutschen**
der Nadeldurch ausgeprägtes
Pyramidenprofil

► **Longer life** through tungsten
carbide inserts

► **No turning or slipping of needle**
through pronounced profile

► **Durabilité supérieure** par
pointes en tungstène

► **Pas de rotation ou glissement de**
l'aiguille par profil prononcé

► **Durabilidad superior** por
puntas de tungsteno

► **Ni rotación ni deslizamiento de**
la aguja por perfil pronunciado

37.2001-1 gerade, gerieft
straight, serrated
droites, striées
rectas, estriadas

37.2002-1 TC GOLD
Hartmetalleinsätze
Tungsten carbide inserts
Pointes en tungstène
Puntas de tungsteno

37.2001-6 gebogen, gerieft
curved, serrated
courbées, striées
curvas, estriadas

37.2002-6 TC GOLD
Hartmetalleinsätze
Tungsten carbide inserts
Pointes en tungstène
Puntas de tungsteno





37.2004-1 TC GOLD
Hartmetalleinsätze
Tungsten carbide inserts
Pointes en tungstène
Puntas de tungsteno

2 / 3

JACOBSON
18 cm



37.2035 TÖNNIS TC GOLD
18 cm, Hartmetalleinsätze
18 cm, tungsten carbide inserts
18 cm, pointes en tungstène
18 cm, puntas de tungsteno

2 / 3



37.2030 CRILE
15 cm

2 / 3

37.2004-6 TC GOLD
Hartmetalleinsätze
Tungsten carbide insert
Pointes en tungstène
Puntas de tungsteno

37.2011 BAUMGARTNER
13 cm, Hartmetalleinsätze
13 cm, tungsten carbide inserts
13 cm, pointes en tungstène
13 cm, puntas de tungsteno

2 / 3



37.2024 TC GOLD
15 cm, Drahtspannzange
15 cm, for wire ligatures
15 cm, pour ligatures de fil
15 cm, para ligaduras de alambre

2 / 3



37.2008 DOYEN
13 cm

2 / 3



37.2012 CRILE-WOOD



15 cm



2 / 3

CRILE-WOOD

37.2014 CRILE-WOOD TC GOLD



15 cm, Hartmetalleinsätze
15 cm, tungsten carbide inserts
15 cm, pointes en tungstène
15 cm, puntas de tungsteno



2 / 3

MAYO-HEGAR

37.2016-16



16 cm

37.2018-16 TC GOLD



16 cm, Hartmetalleinsätze
16 cm, tungsten carbide inserts
16 cm, pointes en tungstène
16 cm, puntas de tungsteno

37.2016-18



18 cm

37.2018-18 TC GOLD



18 cm, Hartmetalleinsätze
18 cm, tungsten carbide inserts
18 cm, pointes en tungstène
18 cm, puntas de tungsteno

37.2020-16 TC GOLD



16 cm, Hartmetalleinsätze
16 cm, tungsten carbide inserts
16 cm, pointes en tungstène
16 cm, puntas de tungsteno

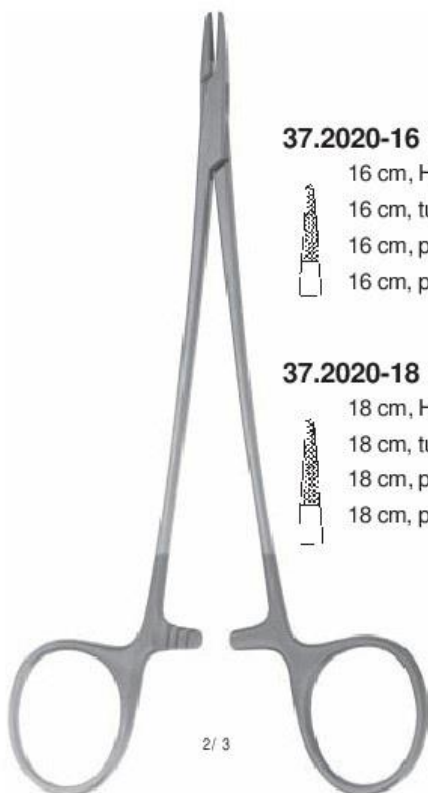

2 / 3

DE BAKEY

37.2020-18 TC GOLD



18 cm, Hartmetalleinsätze
18 cm, tungsten carbide inserts
18 cm, pointes en tungstène
18 cm, puntas de tungsteno



2 / 3

CRILE-RYDER

37.2022-13 TC GOLD



13 cm, Hartmetalleinsätze
13 cm, tungsten carbide inserts
13 cm, pointes en tungstène
13 cm, puntas de tungsteno

37.2022-15 TC GOLD



15 cm, Hartmetalleinsätze
15 cm, tungsten carbide inserts
15 cm, pointes en tungstène
15 cm, puntas de tungsteno

37.2022-18 TC GOLD





18 cm, Hartmetalleinsätze
18 cm, tungsten carbide inserts
18 cm, pointes en tungstène
18 cm, puntas de tungsteno



37.2050-12 BOYNTON



12 cm, Hartmetalleinsätze

-  12 cm, tungsten carbide inserts
-  12 cm, mors en tungstène
-  12 cm, puntas de tungsteno



37.2059 LICHTENBERG-RYDER

14 cm, Hartmetalleinsätze

-  14 cm, tungsten carbide inserts
-  14 cm, pointes en tungstène
-  14 cm, puntas de tungsteno

37.2062 MATHIEU-EISELSBERG

19 cm



37



MATHIEU

14 cm



37.2052



37.2053

37.2057-1 TC GOLD

- Hartmetalleinsätze
-  Tungsten carbide inserts
- Pointes en tungstène
- Puntas de tungsteno

37.2057 TC GOLD

- Hartmetalleinsätze
-  Tungsten carbide inserts
- Pointes en tungstène
- Puntas de tungsteno



MATHIEU

17 cm



37.2054



37.2056

37.2058 TC GOLD

- Hartmetalleinsätze
-  Tungsten carbide inserts
- Pointes en tungstène
- Puntas de tungsteno



2/3



37.2135-OG 2-5 ▼



37.2127-G 13-16 ▼

Nähnadeln mit Federöhr
Suture needles with spring eye
Aiguilles à suture avec chas à ressort
Agujas para sutura con ojo de resorte



37

2/3



37.2150

Nadeldose, Ø 65 mm
Needle case, Ø 65 mm
Boîte à aiguilles, Ø 65 mm
Cajita para agujas, Ø 65 mm

37.2150-1

Innendose gelocht
Interior box punched
Boîte à l'intérieur perforé
Caja interior perforado



37.2110

Nahtpinzette
Suture forceps
Pince à suture
Pinzas para sutura



2 / 3

Instrumentenbehälter
Instrument trays
Boîtes pour instruments
Recipientes para instrumentos

37.2617-1

200 x 100 x 35 mm

37.2617-2

260 x 150 x 50 mm

37.2617-3

300 x 200 x 50 mm



2 / 3

Nierenschalen
Kidney bowls
Bassins réniformes
Riñoneras

37.2619-1

170 x 100 x 35 mm

37.2619-2

250 x 140 x 40 mm

37.2619-3

275 x 150 x 45 mm

37



2 / 3

37.2610 METHOT

Wattebehälter
Cotton holder
Récipient pour coton
Algodonera



2 / 3

37.2613 METHOT

für Watteabfälle
waste receiver
pour déchets de coton
para desechos de algodón

Zylinder-Ampullen-Spritzen
Cartridge syringes
Seringues d'ampoules
Jeringas de ampollas



37.2666-18

1,8 cc

37.2666-22

2,2 cc

Metrisches Gewinde

Metric thread

Vis métrique

Rosca métrica

Ohne Aspiration
Without aspiration device
Sans aspiration
Sin aspiración

37.2666-18 US

1,8 cc

37.2666-22 US

2,2 cc

US-Gewinde

US-thread

Vis amérique

Rosca americana

37



37.2668-18

1,8 cc

37.2668-22

2,2 cc

Metrisches Gewinde

Metric thread

Vis métrique

Rosca métrica

Mit Aspiration
With aspiration device
Avec aspiration
Con aspiración

37.2668-18 US

1,8 cc

37.2668-22 US

2,2 cc

US-Gewinde

US-thread

Vis amérique

Rosca americana



2 / 3

37.2716

10 cc

Wasserspritze selbstfüllend

Water syringe aspirating

Seringue à eau auto-aspirante

Jeringa de agua autoaspirante

Castroviejo Zirkel
Castroviejo calipers
Castroviejo étriers
Castroviejo calibradores



37.1730-1, 9 cm
40 mm, gerade
40 mm, straight
40 mm, droit
40 mm, recto



37.1730-6, 9 cm
40 mm, 45° gewinkelt
40 mm, 45° angled
40 mm, 45°
40 mm, 45°



37.1730-4, 9 cm
20 mm, für Implantat
20 mm, for implants
20 mm,
20 mm,



37.1731-1, 18 cm
40 mm, gerade
40 mm, straight
40 mm, droit
40 mm, recto



37.1731-6, 18 cm
40 mm, gewinkelt
40 mm, angled
40 mm,
40 mm,

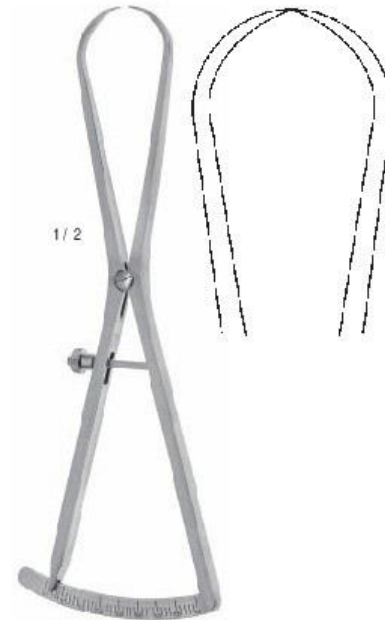

37.1731-4, 18 cm
40 mm, für Implantat
40 mm, for implants
40 mm,
40 mm,



38

DIAGNOSIS
DIAGNOSTIK
DIAGNOSTIC
DIAGNÓSTICO

Mundspiegelgriffe
Mouth mirror handles
Manches à miroirs
Mangos a espejos



38.2770

Serviettenhalter, Länge verstellbar
Napkin holder, length variable
Porte-serviette, longueur changeable
Porta-servilleta, tamaño variable



38.2780



38.2782



38.2783



38.2784

hohl
hollow
creux
hueco



38.2786-1 ECONOMY

hohl
hollow
creux
hueco



38.2787

hohl
hollow
creux
hueco

38

38.2804-4 RHODIUM

plan
plane
plan
plano

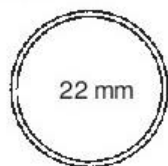

38.2805-4 RHODIUM

vergrößernd
magnifying
agrandissant
de aumento

38.2804-5 RHODIUM

plan
plane
plan
plano

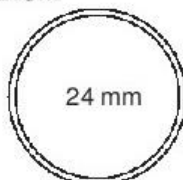

38.2805-5 RHODIUM

vergrößernd
magnifying
agrandissant
de aumento

- ▶ Scharfes + verzerrungsfreies Spiegelbild durch reflektierende Metallschicht direkt auf der Glasoberfläche
- ▶ Sharp + distortion free mirror image through reflective metal layer directly on glass surface

38

38.2808-3 RHODIUM MICRO

3 mm



38.2808-5 RHODIUM MICRO

5 mm



38.2808-36 RHODIUM MICRO

3 x 6 mm



38.2806-4 RHODIUM

Mega-Spiegel - plan, Fig. 4
Mega mirror - plane, Fig. 4
Mega miroir - plan, Fig. 4
Mega espejo - plano, Fig. 4



38.2800-3

plan
plane
plan
plano

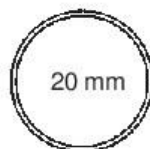

38.2800-4

plan
plane
plan
plano

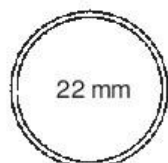

38.2801-4

vergrößernd
magnifying
agrandissant
de aumento



STANDARD

38.2800-5

plan
plane
plan
plano

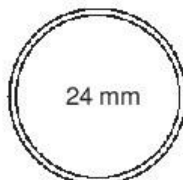

38.2801-5

vergrößernd
magnifying
agrandissant
de aumento

Diamantierte Spitzen zum Entfernen von Fremdkörpern
Diamonded tips for removing foreign bodies
Pointes diamantées pour écarter corps étrangers
Puntas diamantadas para sacar cuerpos extraños

- ▶ **Überlegene Rostsicherheit** durch extra polierte Schweißnaht
- ▶ **Sicherer Schluß auch unter Druck** durch besonderen Stopstift
- ▶ **Superior corrosion resistance** through specially polished weld
- ▶ **Secure closing even under pressure** through special stopping pin
- ▶ **Meilleur résistance à la rouille** par une soudure fourbie spécialement
- ▶ **Fermeture assurée même sous compression** par un arrêt spécial
- ▶ **Mejor protección contra el moho** por una soldadura pulida
- ▶ **Cierra seguramente aun con compresión** por una espiga particular

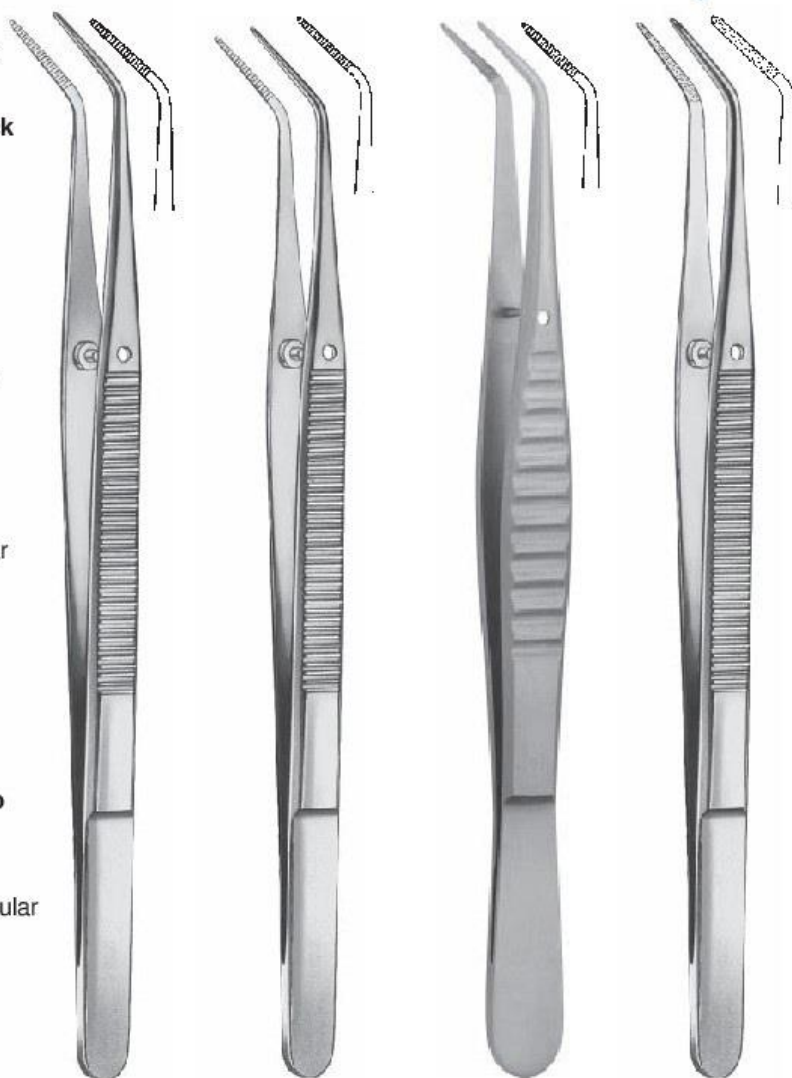

38

38.2885 COLLEGE	38.2886 COLLEGE	38.2887 COLLEGE	38.2888 COLLEGE
gerieft	feine Spitzen	kräftige Spitzen	diamantierte Spitzen
serrated	fine tips	strong tips	diamonded tips
striée	pointes fines	pointes robustes	pointes diamantées
estriada	puntas finas	puntas fuertes	puntas diamantadas



verhindert das Übereinandergleiten der Spitzen
prevents side-slipping of tips
évite le glissement latéral des pointes
evita que las puntas se desvien al lado

38



- | | | | | | |
|------------------------|------------------------|------------------------|------------------------|------------------------|----------------------|
| 38.2884 COLLEGE | 38.2889 COLLEGE | 38.2880 COLLEGE | 38.2881 COLLEGE | 38.2883 COLLEGE | 38.2988 |
| glatt | gerieft mit Schloß | glatt | gerieft | gerieft | für Silberspitzen |
| smooth | serrated with ratchet | smooth | serrated | serrated | for silver points |
| lisse | striée avec arrêt | lisse | striée | striée | pour cônes d'argent |
| lisa | estriada con cierre | lisa | estriada | estriada | para puntas de plata |

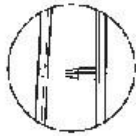

verhindert das Übereinandergleiten der Spitzen
prevents side-slipping of tips
évite le glissement latéral des pointes
evita que las puntas se desvien al lado

38



38.2875 COLLEGE
gerieft
serrated
striée
estriada



38.2891 COLLEGE
gerieft
serrated
striée
estriada



38.2931 LANDGRAF
gerieft
serrated
striée
estriada



38.2913 PERRY
gerieft
serrated
striée
estriada



38.2915 PERRY
gerieft
serrated
striée
estriada

38.2871 COLLEGE
gerieft
serrated
striée
estriada

38

Diamantierte Spitzen zum Entfernen von Fremdkörpern
Diamonded tips for removing foreign bodies
Pointes diamantées pour écarter corps étrangers
Puntas diamantadas para sacar cuerpos extraños



38.2921 FLAGG
gerieft
serrated
striée
estriada



38.2943 MERIAM
gerieft
serrated
striée
estriada



38.2942 MERIAM
glatt
smooth
lisse
lisa



38.2948 MERIAM
diamantierte Spitzen
diamonded tips
pointes diamantées
puntas diamantadas



38.2959 MERIAM
gerieft
serrated
striée
estriada

Zahnsonden
Explorers
Sondes
Sondas

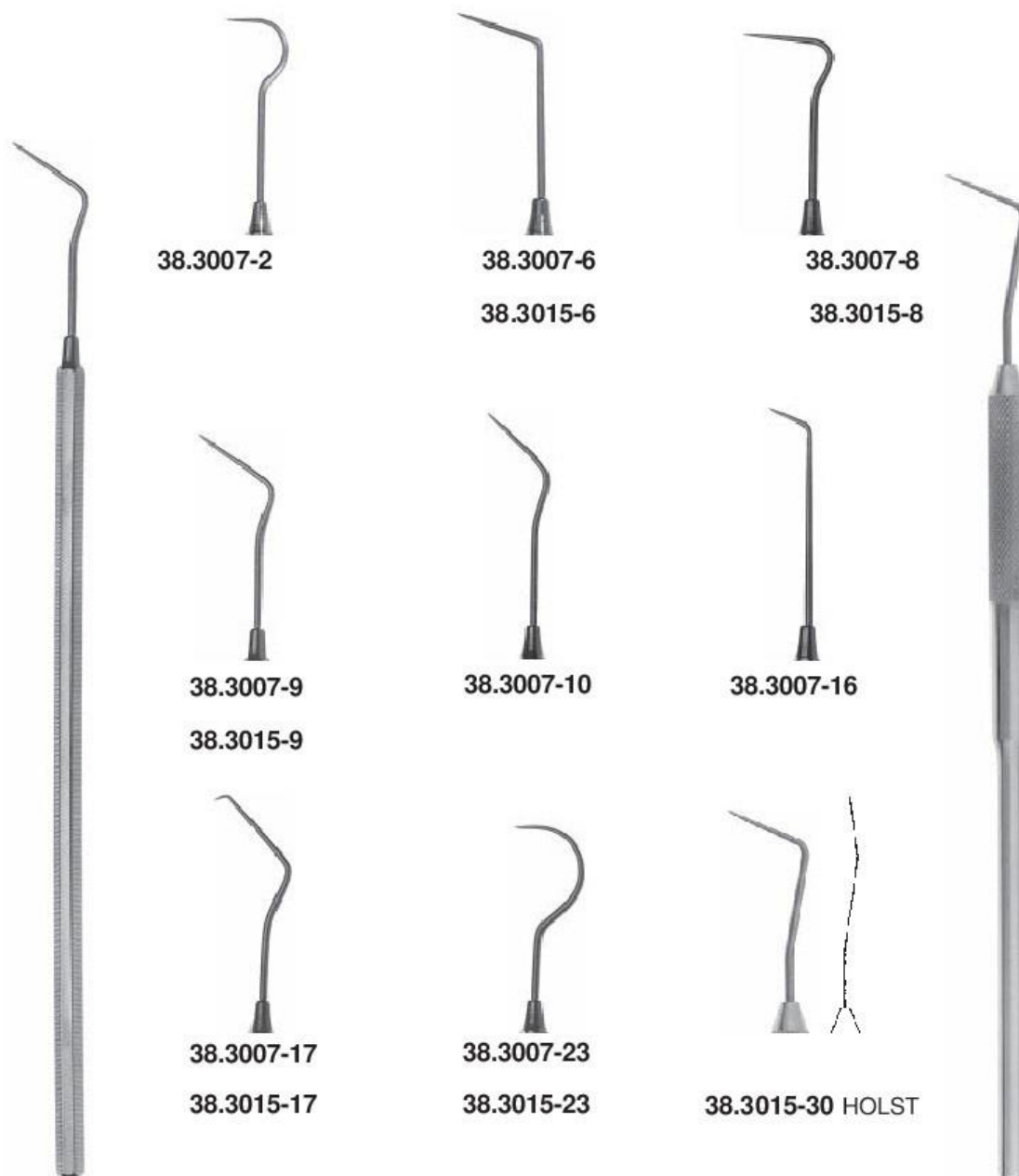

38.3007-2

38.3007-6

38.3007-8

38.3015-6

38.3015-8

38.3007-9

38.3007-10

38.3007-16

38.3015-9

38.3007-17

38.3007-23

38.3015-17

38.3015-23

38.3015-30 HOLST

38

38.3007- UNIVERSAL

Achtkantgriff, kräftige Spitzen
Octagonal handle, strong tips
Manche octagonal, pointes robustes
Mango octagonal, puntas fuertes

38.3015- UNIVERSAL

Rundgriff, kräftige Spitzen
Round handle, strong tips
Manche rond, pointes robustes
Mango redando, puntas fuertes

38



UNIVERSAL

Kräftige Spitzen
Strong tips
Pointes robustes
Puntas fuertes



38.3054-4



38.3054-88



38.3054-5



38.3054-8

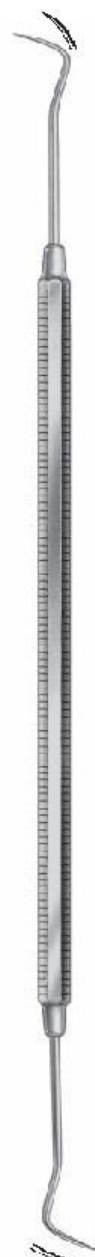

38.3058 WESTON

Kräftige Spitzen
Strong tips
Pointes robustes
Puntas fuertes



38.3075-5 UNIVERSAL

Kräftige Spitzen
Strong tips
Pointes robustes
Puntas fuertes

► **Extrem feine und flexible Spitzen**
aus einer Speziallegierung ermöglichen das Ertasten kleinster Defekte

► **Very delicate and flexible tips**
made from a special alloy allow for detection of smallest defects

► **Un bout très pointu et flexible**
fabriqué d'un alliage spécial permet la découverte des plus petits défauts

► **Puntas muy delgadas y flexibles**
fabricadas de una aleación especial facilitan el descubrimiento de defectos pequenitos



OPTIFLEX

Sehr feine Spitzen
Very fine tips
Pointes très fines
Puntas muy finas



38.3016-8 OPTIFLEX



38.3016-9 OPTIFLEX



38.3016-17 OPTIFLEX



38.3016-23 OPTIFLEX

38



38.3074-110 OPTIFLEX

Sehr feine Spitzen
Very fine tips
Pointes très fines
Puntas muy finas



38.3074-5 OPTIFLEX

Sehr feine Spitzen
Very fine tips
Pointes très fines
Puntas muy finas



38.3078 OPTIFLEX

Wurzelkanal-Sonde
Root canal probe
Sonde à canaux
Sonda para conductos radiculares



MEDIUM

Mittelfeine Spitzen
Medium fine tips
Pointes mi-fines
Puntas semifinas



38.3013-8 MEDIUM



38.3013-9 MEDIUM



38.3013-17 MEDIUM



38.3013-23 MEDIUM

Parodontal-Sonden
Periodontal probes
Sondes parodontales
Sondas paradontales



38.3077-2 NABERS
Fig. Q2N

38.3076

38.3410 WHO

38.3410-1 WHO

38.3412 WILLIAMS

38.3418
Fig. CP10

38

Parodontal-Sonden
Periodontal probes
Sondes parodontales
Sondas paradontales

38



38.3419
Fig. CP2



38.3419-3-3
Fig. CP12



38.3419-3-6
Fig. CP11



38.3418-15
Fig. CP15



38.3422-1



38.3421 HAUER



39

PERIODONTIA
PARODONTOLOGIE
PARODONTOLOGIE
PERIODONCIA

ANWENDUNG KÜNRETTE

Oberkiefer
Upper jaw
Mâchoire supérieure
Maxilar superior

Unterkiefer
Lower jaw
Mâchoire inférieure
Maxilar inferior

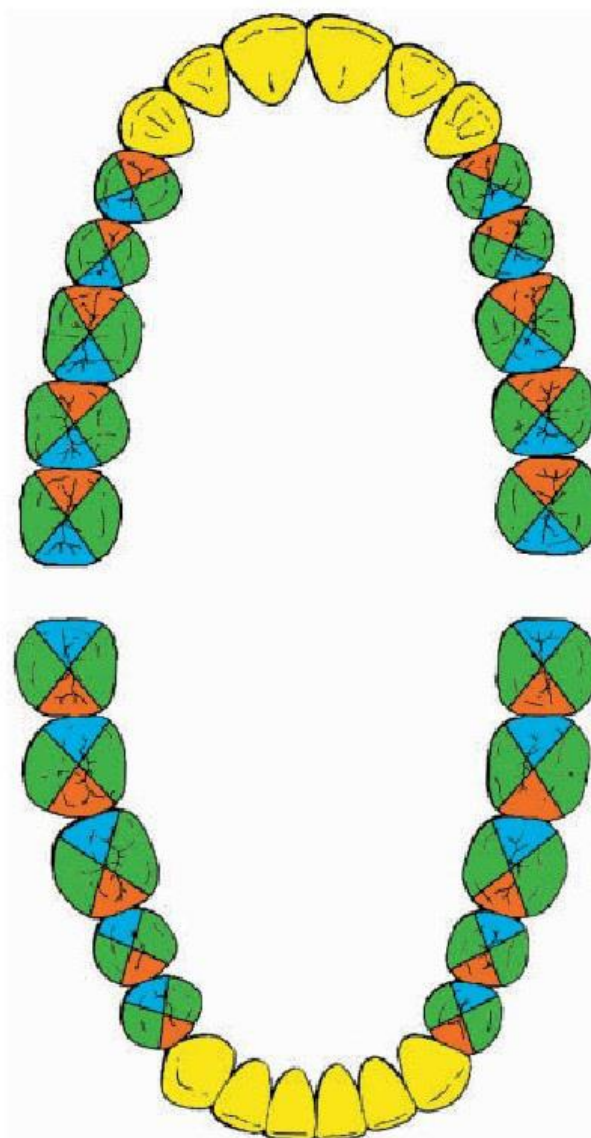

Fig. 1/2 oder Fig. 5/6



Fig. 7/8 oder Fig. 9/10



Fig. 11/12 oder Fig. 15/16



Fig. 13/14 oder Fig. 17/18



Zahnreiniger
Scalers
Instruments à détartrer
Limpiadores de sarro



39.3100-1



39.3100-2



39.3153

Fig. 6B



39.3168-4 HYGIENIST

Fig. H4



39.3168-5 HYGIENIST

Fig. H5



39.3100-3



39.3100-7



39.3154

Fig. 6D



39.3168-6 HYGIENIST

Fig. H6



39.3168-7 HYGIENIST

Fig. H7



39.3100-32



39.3144 THORPE

Zahnreiniger
Scalers
Instruments à détartrer
Limpiadores de sarro

39



39.3169-1 HYGIENIST

Fig. H5



39.3169-12 HYGIENIST



39.3169-6 HYGIENIST

Fig. H6



39.3169-7 HYGIENIST

Fig. H7



39.3253 CUMINE



39.3254 MITCHELL

Osteotrimmer

Zahnreiniger
Scalers
Instruments à détartrer
Limpiadores de sarro

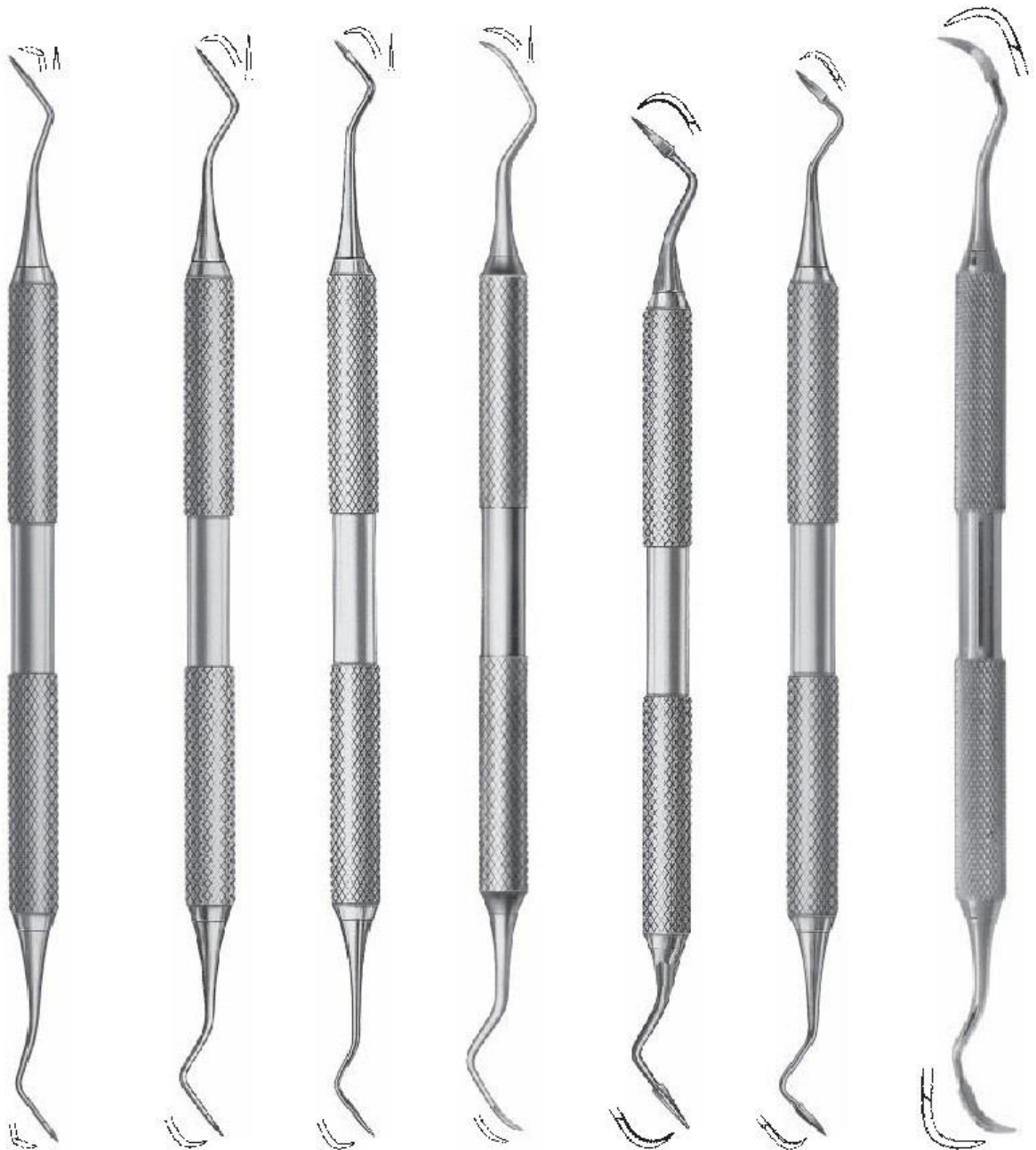

39

39.3274-1 JACQUETTE **39.3274-2** **39.3274-204** **39.3380-139** **39.3275** **39.3275-23 TAYLOR** **39.3276 CRANE-KAPLAN**
 Fig. 34/35 Fig. 204 S Fig. IU 13/14 Fig. 2/3 Fig. 2/3 Fig. 6

Zahnreiniger
Scalers
Instruments à détartrer
Limpiadores de sarro

39

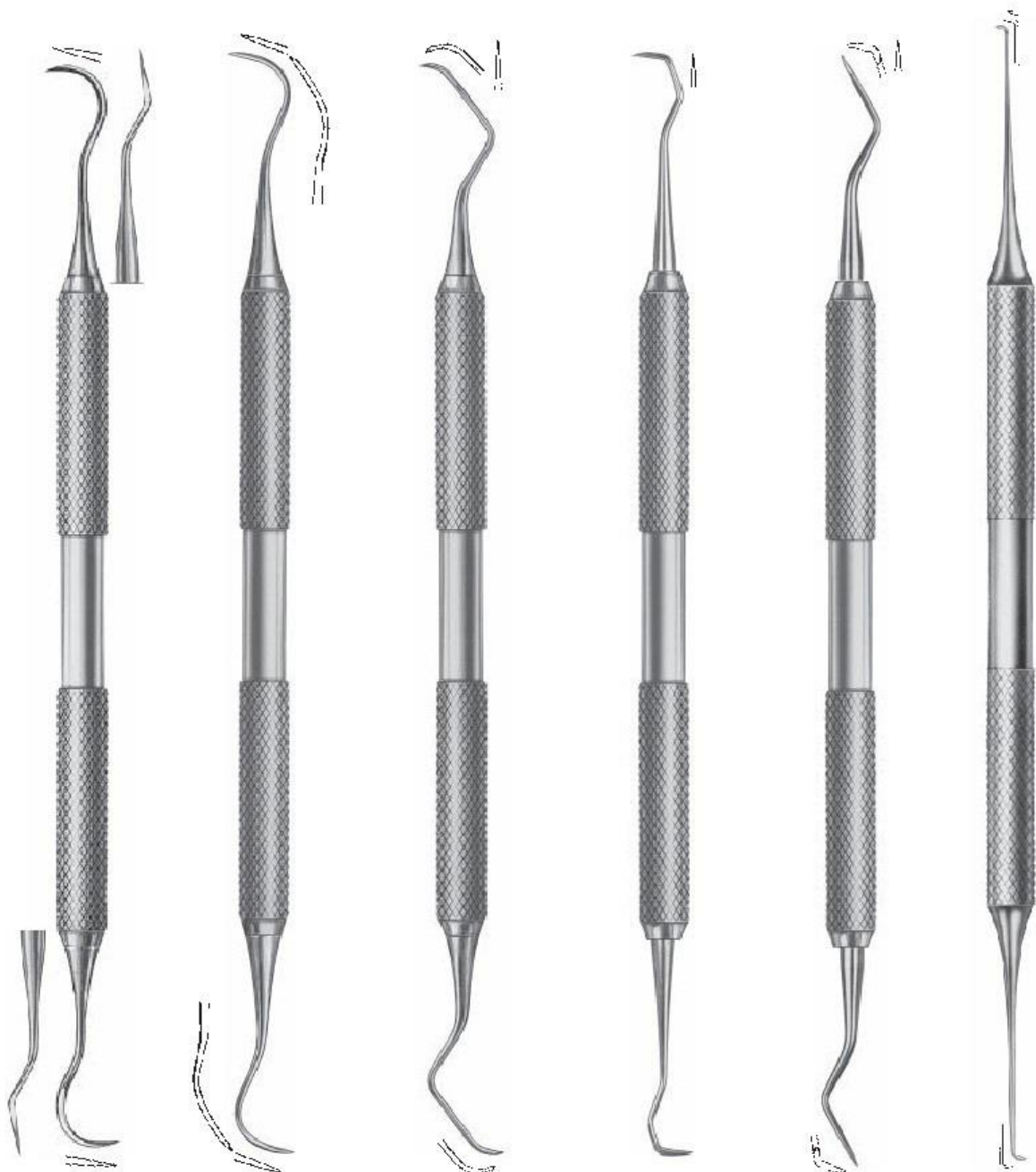

39.3274-6

Fig. H 6/H 7

39.3380-171 MC CALL

Fig. 17S/18S

39.3380-131 MC CALL

Fig. 13S/14S

39.3274-30

Fig. 30/33

39.3274-31

Fig. 31/32

39.3274-102 MORSE

Fig. 0/00

Zahnreiniger
Scalers
Instruments à détartrer
Limpiadores de sarro

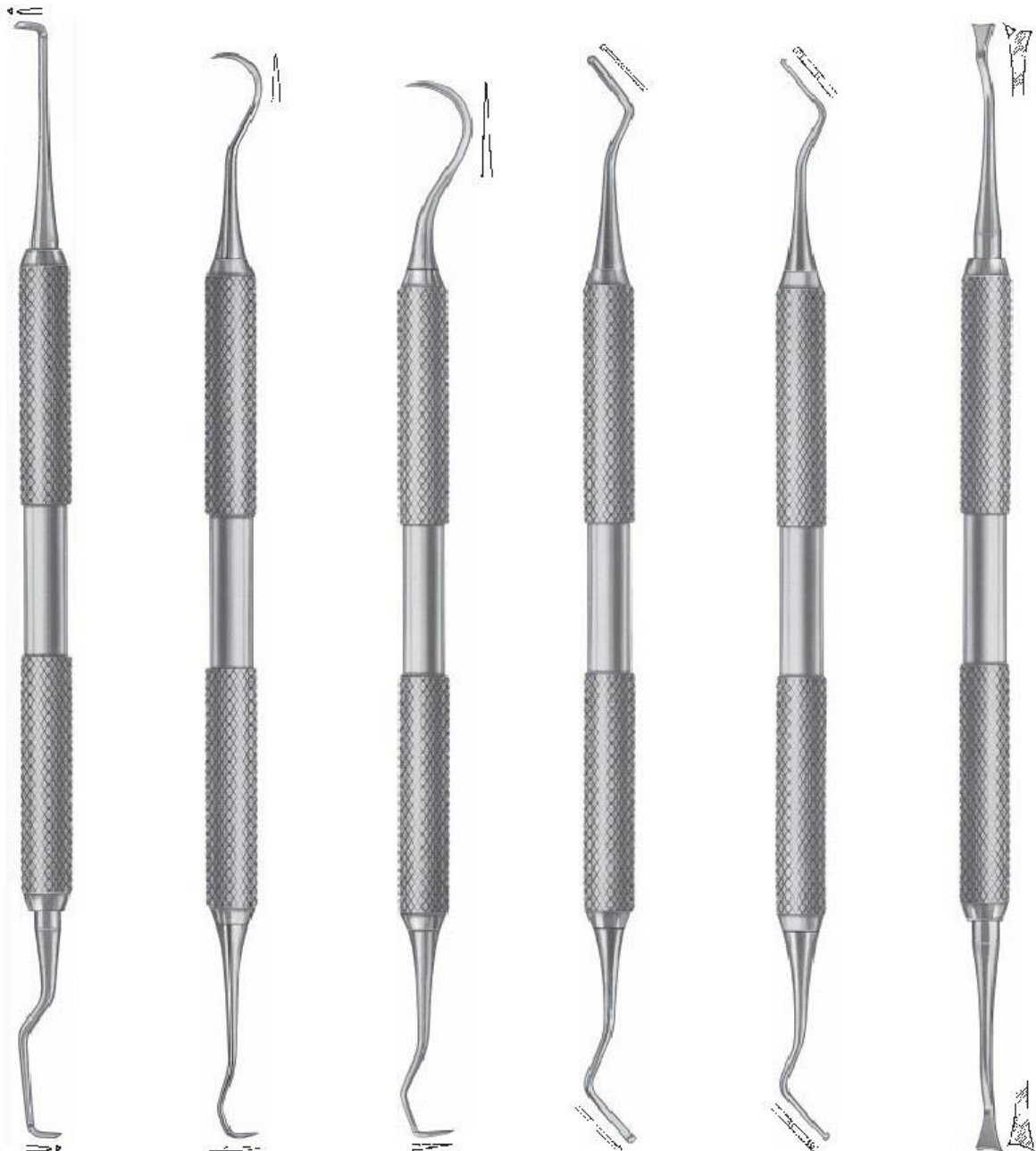

39.3376-1

Fig. GF1

39.3274-533

Fig. 5/33

39.3278 TOWNER

Fig. U 15/30

39.3376-5

Fig. GF5

39.3376-6

Fig. GF6

39.3383

Fig. GF10

Küretten
Curettes
Curettes
Curetas

39



GRACEY

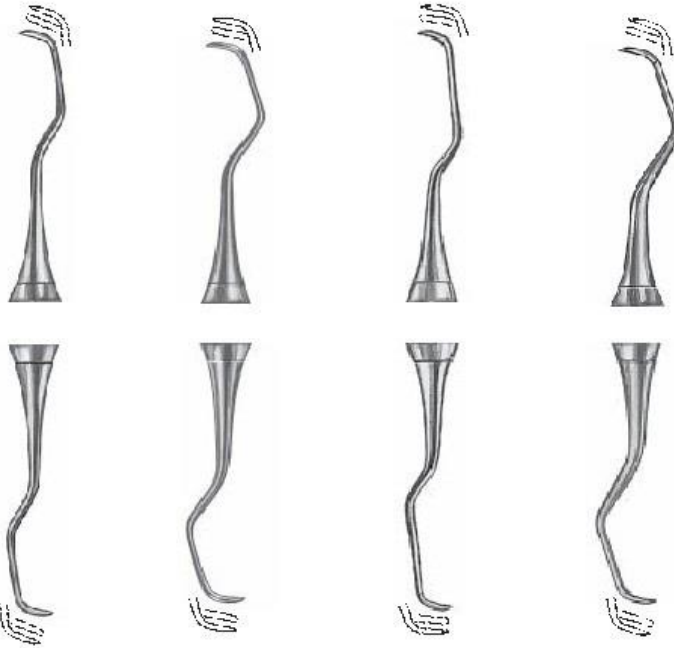

39.3377-1 GRACEY **39.3377-3 GRACEY** **39.3377-5 GRACEY** **39.3377-7 GRACEY**
 Fig. 1/2 Fig. 3/4 Fig. 5/6 Fig. 7/8
 1-3 1-5 1-5 lingual + buccal
 4-8

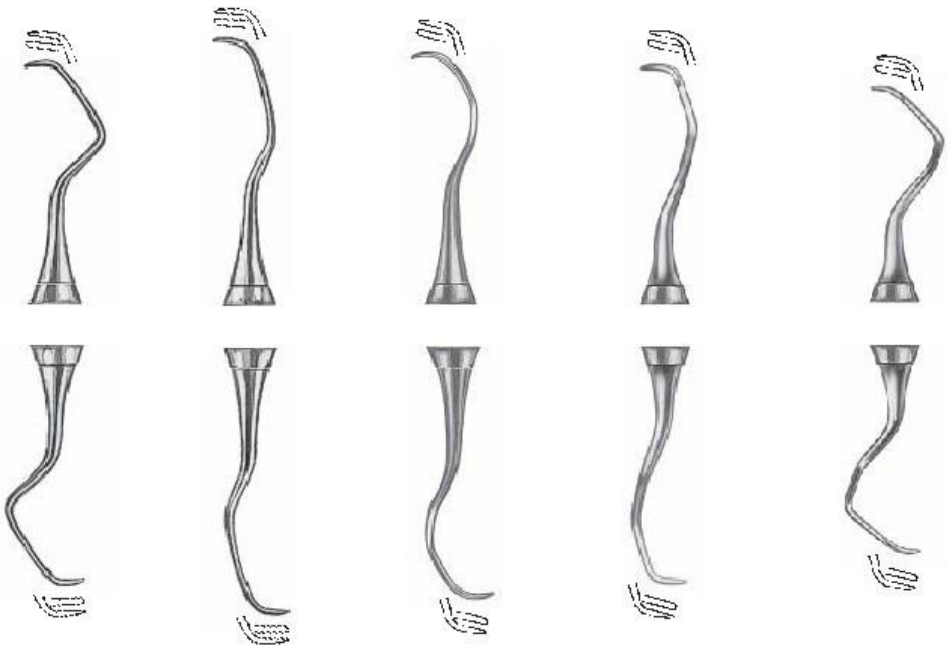

39.3377-9 **39.3377-11** **39.3377-13** **39.3377-15** **39.3377-17**
 Fig. 9/10 Fig. 11/12 Fig. 13/14 Fig. 15/16 Fig. 17/18
 lingual + buccal mesial distal mesial distal
 4-8 4-8 4-8 4-8 4-8

Für tiefe Taschen, Miniatur
For deep pockets, Miniatur
Pour poches profondes, Miniature
Para bolsas profundas, Miniatur

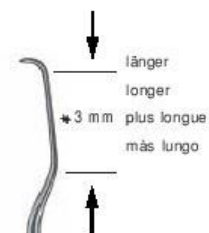

39

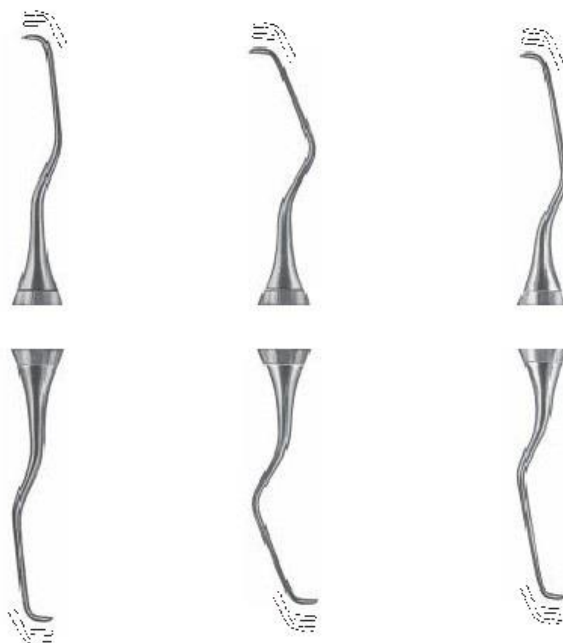

39.3377-101 GRACEY

Fig. 1/2, miniatur

☞ 1-3

39.3377-103 GRACEY

Fig. 3/4, miniatur

☞ 1-5

39.3377-105 GRACEY

Fig. 5/6, miniatur

☞ 1-5

GRACEY
miniatur



39.3377-107

Fig. 7/8, miniatur
lingual + buccal

☞ 4-8



39.3377-109

Fig. 9/10, miniatur
lingual + buccal

☞ 4-8



39.3377-111

Fig. 11/12, miniatur
mesial

☞ 4-8



39.3377-113

Fig. 13/14, miniatur
distal

☞ 4-8

Furchungsküretten
Curettes for root depressions
Curettes pour dépressions radicaire
Curetas para depresiones en la raíz

Normale Kürette
Normal Curette
Curette normale
Cureta normal

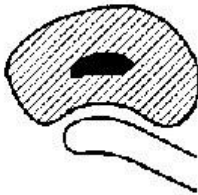
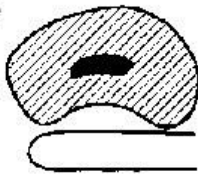

- ▶ Optimale Reinigung/Glättung vertikaler Wurzeinziehungen
- ▶ Optimal planing of vertical depressions on root surfaces
- ▶ Curettage optimal de dépressions verticales sur la surface des racines
- ▶ Óptima limpieza de contracciones verticales en la superficie de la raíz



39.3372-11 GEURTSSEN-GÜNAY

Fig. 11/12

mesial

4 - 8



39.3372-13 GEURTSSEN-GÜNAY

Fig. 13/14

distal

6 - 8

Universalküretten
Universal curettes
Curettes universelles
Curetas universales

39

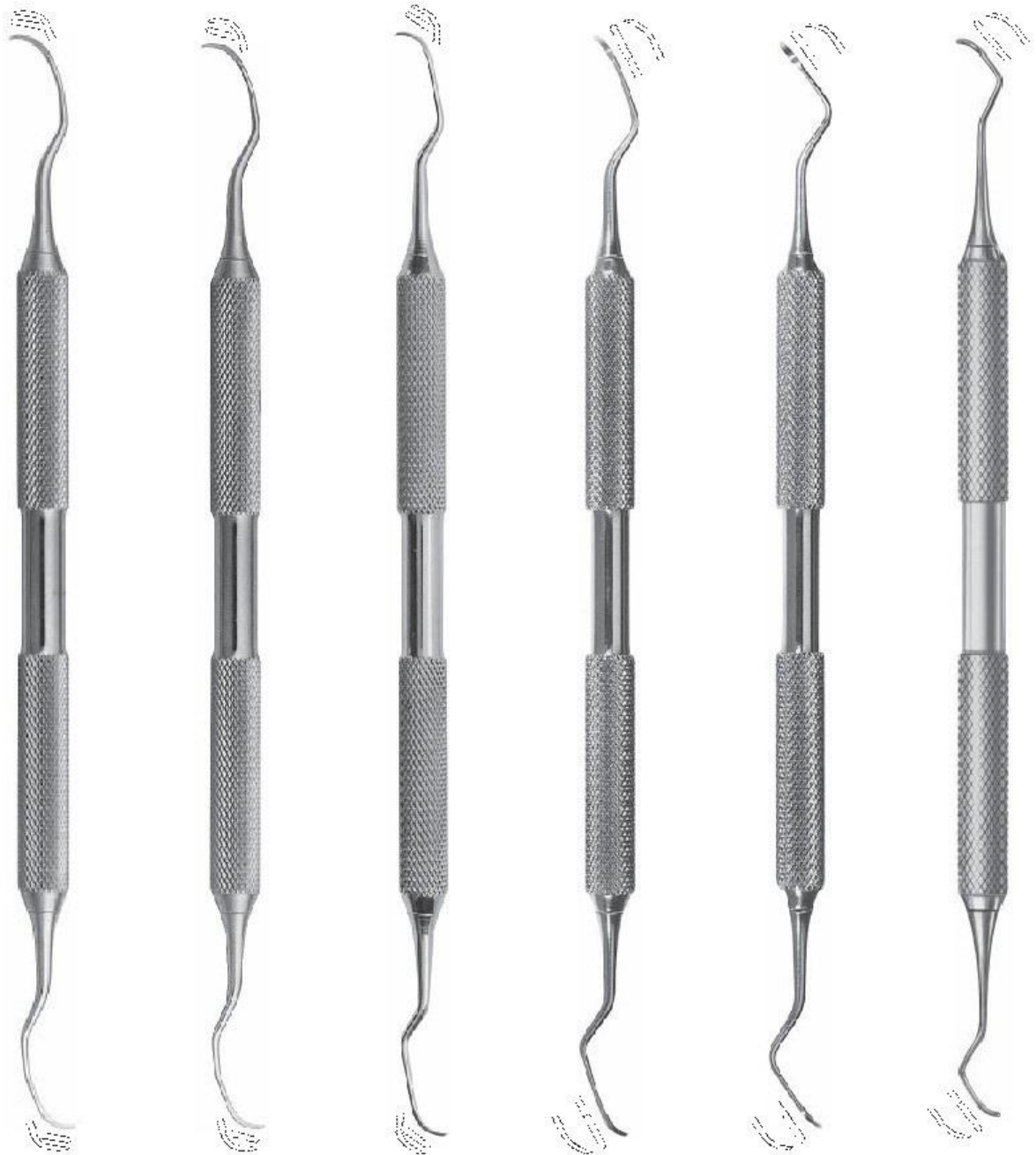

39.3377-91 LANGER	39.3377-93 LANGER	39.3377-95 LANGER	39.3379-2 COLUMBIA	39.3379-4 COLUMBIA	39.3379-13 COLUMBIA
Fig. L 1/2	Fig. L 3/4	Fig. L 5/6	Fig. 2L/2R	Fig. 4L/4R	Fig. 13/14
34 - 38 44 - 48	14 - 18 24 - 28	1 - 3	1 - 5	6 - 8	6 - 8 Wurzeln · roots racines · raíces



39.3380-13 MC CALL
Fig. 13/14



39.3380-17 MC CALL
Fig. 17/18



39.3370 YOUNGER-GOOD
Fig. 7/8



39.3371



39.3376-2 GOLDMANN-FOX
Fig. GF2
1 - 5

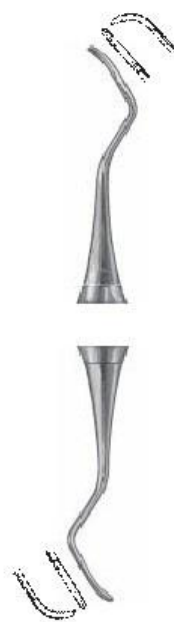

39.3376-3 GOLDMANN-FOX
Fig. GF3, interdental
6 - 8

39

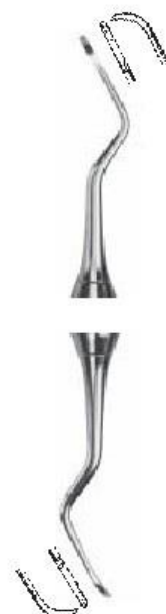

39.3376-4 GOLDMANN-FOX
Fig. GF4
6 - 8

39

- ▶ Schnellwechsel ohne Werkzeug
- ▶ Spitzen stehen automatisch in richtiger Position
- ▶ Abgedichteter Verschluss

- ▶ Fast tip change without tools
- ▶ Tips are automatically aligned in correct position
- ▶ Sealed closure

- ▶ Remplacement rapide des points sans aucun outil
- ▶ Pointes tenues toujours en position correcte
- ▶ Fermeture étanchée

- ▶ Rápido cambio sin utensilios
- ▶ Puntas siempre alineadas en posición correcta
- ▶ Atornillado empaquetado

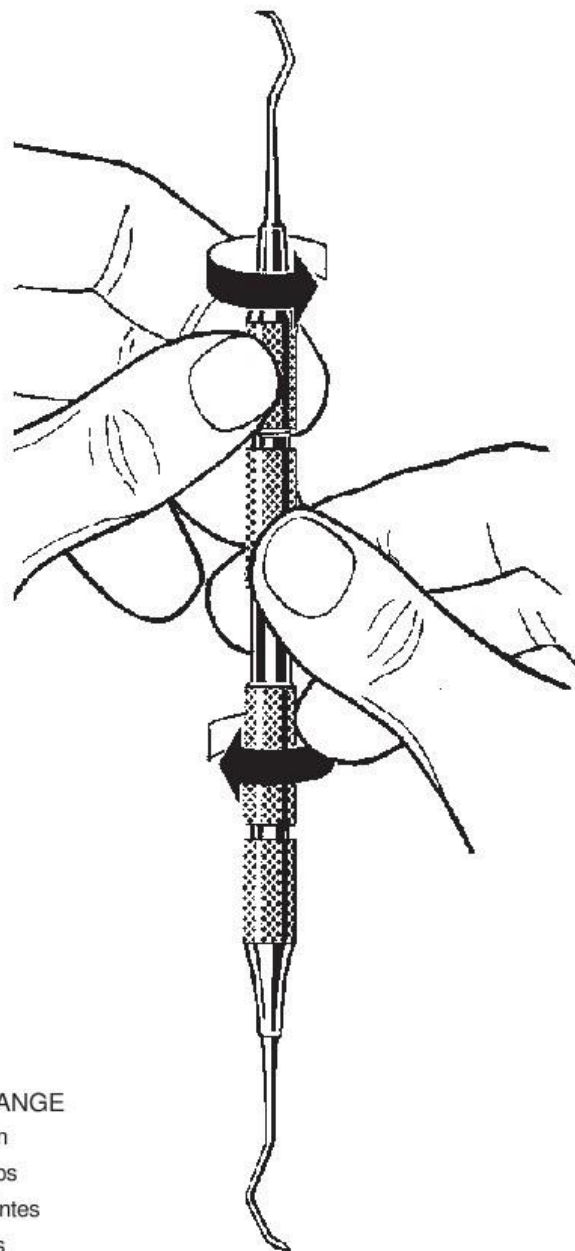

39.3330 QUICK-CHANGE

Griff ohne Spitzen
Handle without tips
Manche sans pointes
Mango sin puntas



39.3334-6 HYGIENIST

Fig. H6

Spitze · tip · pointe
punta



39.3334-7 HYGIENIST

Fig. H7

Spitze · tip · pointe
punta



39.3334-22

Fig. 2

Spitze · tip · pointe
punta



39.3334-23

Fig. 3

Spitze · tip · pointe
punta

QUICK-CHANGE



39.3347-5 GRACEY
Fig. 5
Spitze · tip · pointe
punta



39.3347-6 GRACEY
Fig. 6
Spitze · tip · pointe
punta



39.3347-7 GRACEY
Fig. 7
Spitze · tip · pointe
punta



39.3347-8 GRACEY
Fig. 8
Spitze · tip · pointe
punta



39.3347-11 GRACEY
Fig. 11
Spitze · tip · pointe
punta



39.3347-12 GRACEY
Fig. 12
Spitze · tip · pointe
punta



39.3347-13 GRACEY
Fig. 13
Spitze · tip · pointe
punta



39.3347-14 GRACEY
Fig. 14
Spitze · tip · pointe
punta



39.3340-13 MC CALL
Fig. 13
Spitze · tip · pointe
punta



39.3340-14 MC CALL
Fig. 14
Spitze · tip · pointe
punta



39.3340-17 MC CALL
Fig. 17
Spitze · tip · pointe
punta



39.3340-18 MC CALL
Fig. 18
Spitze · tip · point
punta

Parodontalmesser
Gingivectomy knives
Bistouris pour la gingivectomie
Bisturías para la gingivectomía

39



39.3395 KIRKLAND
Fig. 15K/16K

39.3396
Fig. GF7

39.3397
Fig. GF8

39.3398
Fig. GF11

39.3399 ORBAN
Fig. 1/2

39.3399-2 ORBAN
Fig. 3/4

Zur Gewebeentfernung
For removing tissue
Pour retirer le tissu
Para quitar el tejido

Feilen
Files
Limes
Limas

Gewebezängchen
Tissue nippers
Pincès à couper le tissu
Pinzas para cortar tejidos



39.3378

Fig. GF9



39.3232 HIRSCHFELD

Fig. 3/7



39.3232-2 HIRSCHFELD

Fig. 5/11



39.3233-9 SCHLUGER

Fig. 9/10



39.3438-10 COHEN

10 cm

39.3438-16 SUGARMAN

16 cm



39.3439-10 COHEN

10 cm

39.3439-13 ILIC

13 cm



40

CONSERVATIVE
KONSERVIERENDE
CONSERVATRICE
CONSERVACIÓN

Schmelzmeißel
Enamel chisels
Ciseaux à émail
Cinceles para esmalte

Gingivalrandschräger
Gingival margin trimmers
Finisseurs à bords gingivaux
Recortadores del margen gingival



40.3446

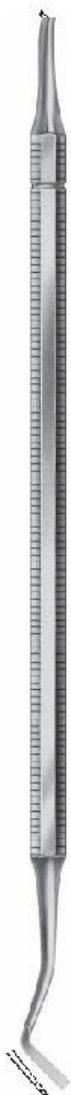

40.3452-51 BLACK
15 - 8 - 12
1,5 mm



40.3453-51 BLACK
15 - 8 - 12
1,5 mm



40.3453-11
11 - 8 - 8
1,1 mm



40.3453-29
10 - 80 - 7 - 14
1,0 mm



40.3453-28
10 - 95 - 7 - 14
1,0 mm

40

Gingivalrandschräger
Gingival margin trimmers
Finsseurs à bords gingivaux
Recortadores del margen gingival

40

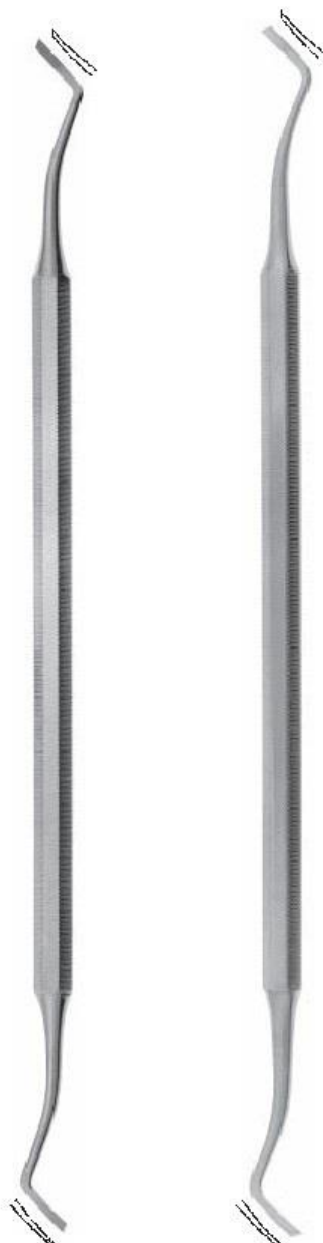

40.3452-77 BLACK

15 - 95 - 8 - 12

Fig. 77/78, 1,5 mm

40.3452-79 BLACK

15 - 80 - 8 - 12

Fig. 79/80, 1,5 mm



40.3453-77 BLACK

15 - 95 - 8 - 12

Fig. 77/78, 1,5 mm



40.3453-79 BLACK

15 - 80 - 8 - 12

Fig. 79/80, 1,5 mm

40.3455-77 BLACK TC GOLD **40.3455-79 BLACK TC GOLD**

Fig. 77/78, 1,5 mm

Fig. 79/80, 1,5 mm

Hartmetalleinsätze

Hartmetalleinsätze

Tungsten carbide inserts

Tungsten carbide inserts

Mors en tungstène

Mors en tungstène

Puntas de tungsteno

Puntas de tungsteno



40.4112-10

zum Entfernen von
provisorischen Füllungen
for removal of
temporary fillings

pour enlever
obturations temporaires
para remover
obturaciones provisionales

Exkavatoren
Excavators
Excavateurs
Excavadores

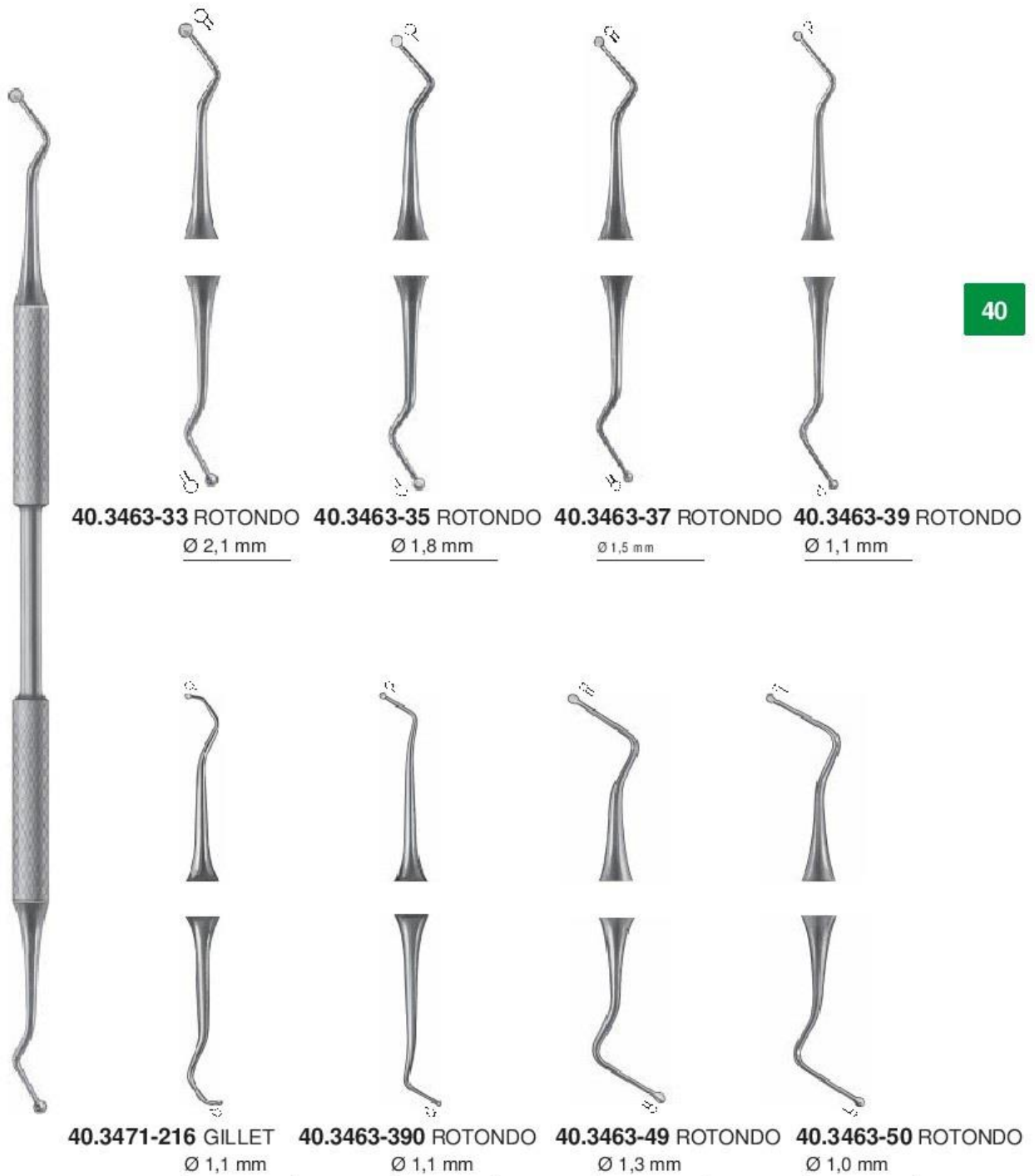

Exkavatoren
Excavators
Excavateurs
Excavadores

40



40.3462-23
Ø 2,1 mm



40.3462-25
Ø 1,8 mm



40.3462-27
Ø 1,5 mm



40.3462-29
Ø 1,1 mm



40.3462-31
Ø 2,5 mm



40.3462-33
Ø 2,1 mm



40.3462-35
Ø 1,8 mm



40.3462-37
Ø 1,5 mm



40.3462-39
Ø 1,1 mm

Exkavatoren
Excavators
Excavateurs
Excavadores



40.3462-43

Ø 2,1 mm



40.3462-45

Ø 1,8 mm



40.3462-47

Ø 1,5 mm



40.3462-49

Ø 1,1 mm



40.3462-53

Ø 2,1 mm



40.3462-55

Ø 1,8 mm



40.3462-57

Ø 1,5 mm



40.3462-59

Ø 1,1 mm



40

Exkavatoren
Excavators
Excavateurs
Excavadores

40



DARBY-PERRY



40.3470-210

Fig. 210/211



40.3470-212

Fig. 212/213



40.3470-214

Fig. 214/215



40.3470-216

Fig. 216/217



40.3470-218

Fig. 218/219



40.3470-220

Fig. 220/221



40.3471-101



40.3471-218 DARBY-PERRY

Fig. 218/219

Exkavatoren
Excavators
Excavateurs
Excavadores

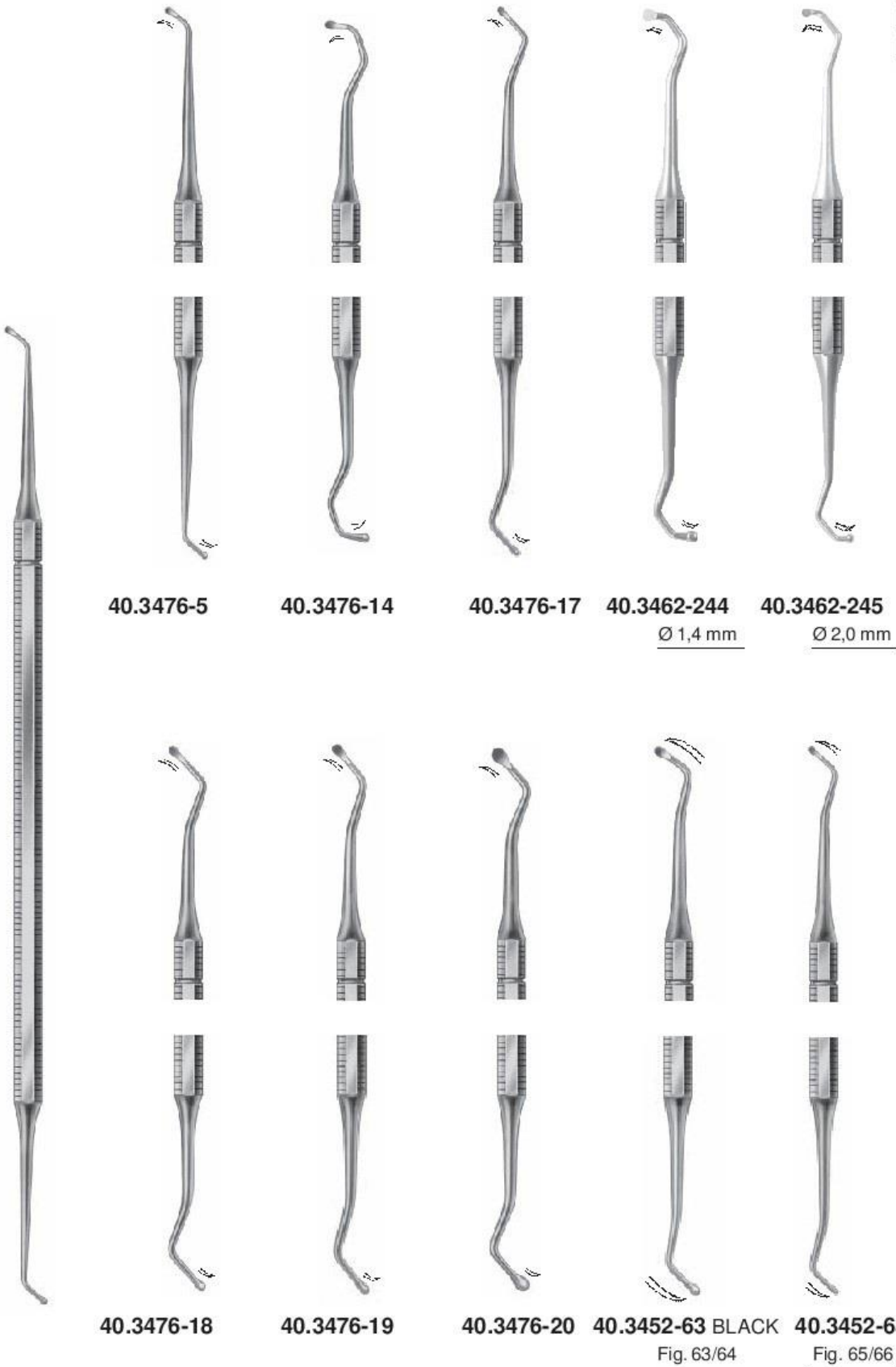

40

40



40.3767

18 cm

40.3767-1

Ersatzspitzen aus Kunststoff

Plastic replacement tips

Pointes de rechange en plastique

Puntas de recambio de plástico



40.3768 IVORY

16 cm

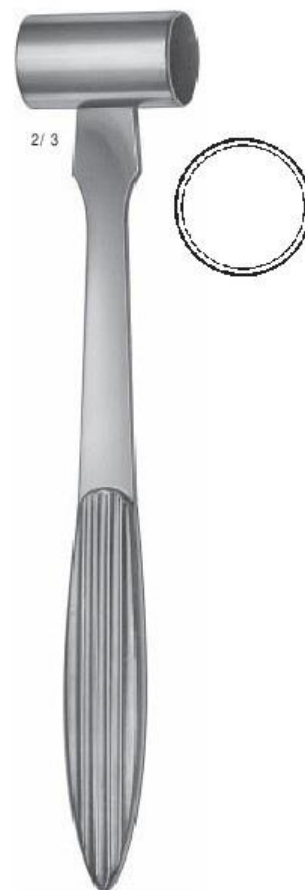

40.3740

Plombierhammer, 19 cm, 180 g, bleigefüllt

Plugging mallet, 19 cm, 180 g, lead filled

Maillet pour aurification, 19 cm, 180 g, rempli de plomb

Martillo para orificaciones, 19 cm, 180 g, relleno de plomo

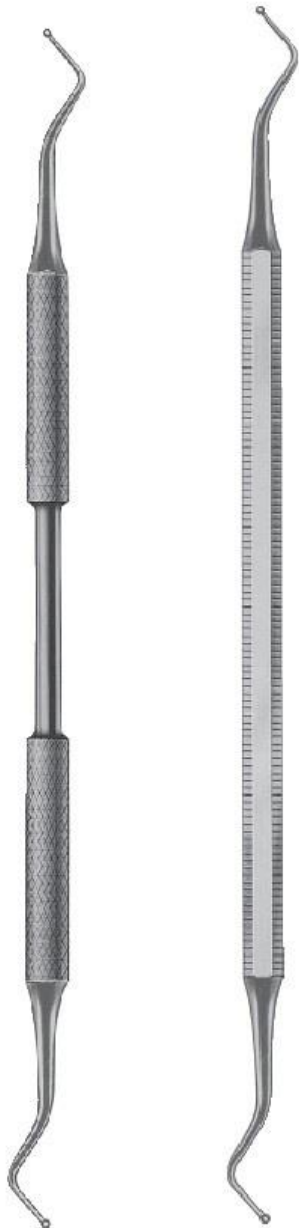

40.3901-ROTONDO

Rundgriff
Round handle
Manche rond
Mango redondo

40.3902-OCTO

Achtkantgriff
Octagonal handle
Manche octogonal
Mango octagonal

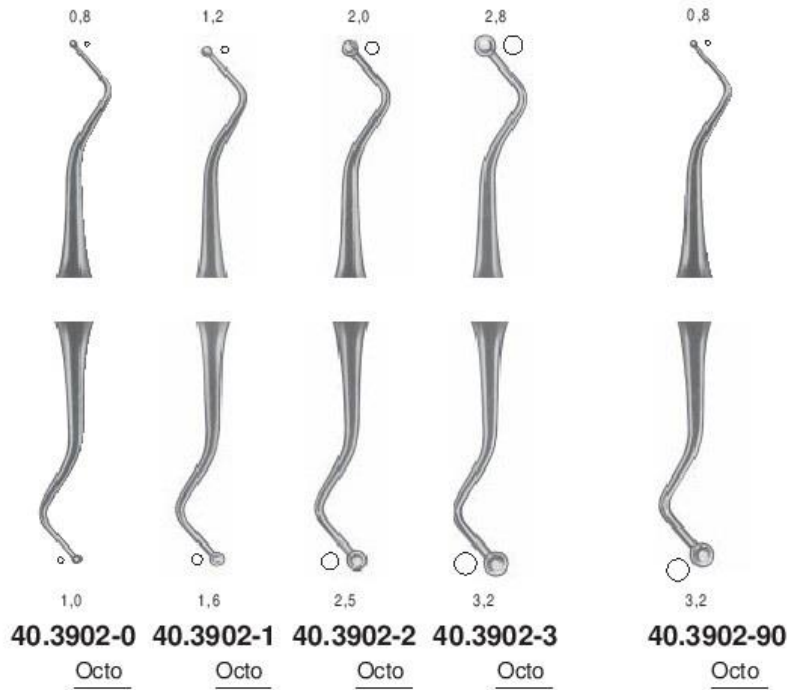

40.3902-0 **40.3902-1** **40.3902-2** **40.3902-3** **40.3902-90**
Octo Octo Octo Octo Octo

40.3901-0 **40.3901-1** **40.3901-2** **40.3901-3**
Rotondo Rotondo Rotondo Rotondo

40

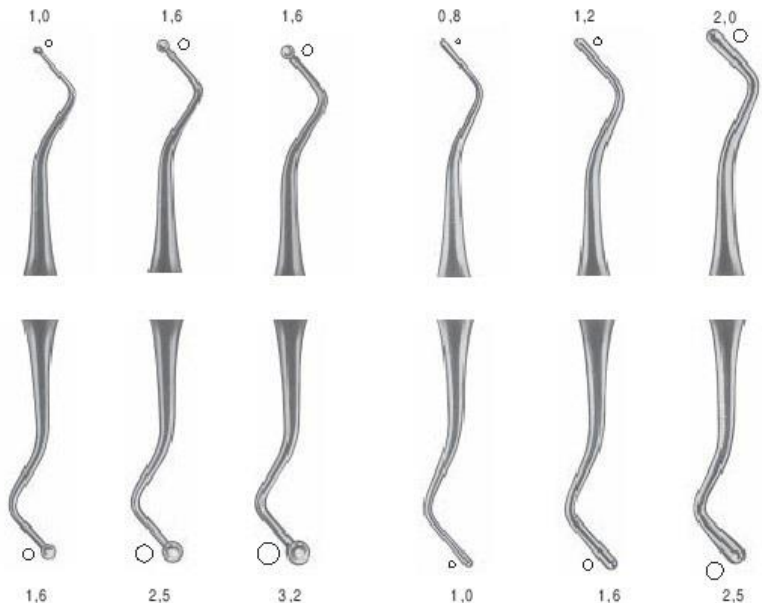

40.3902-91 **40.3902-92** **40.3902-93** **40.3902-4** **40.3902-5** **40.3902-6**
Octo Octo Octo Octo Octo Octo

40.3901-4 **40.3901-5**
Rotondo Rotondo

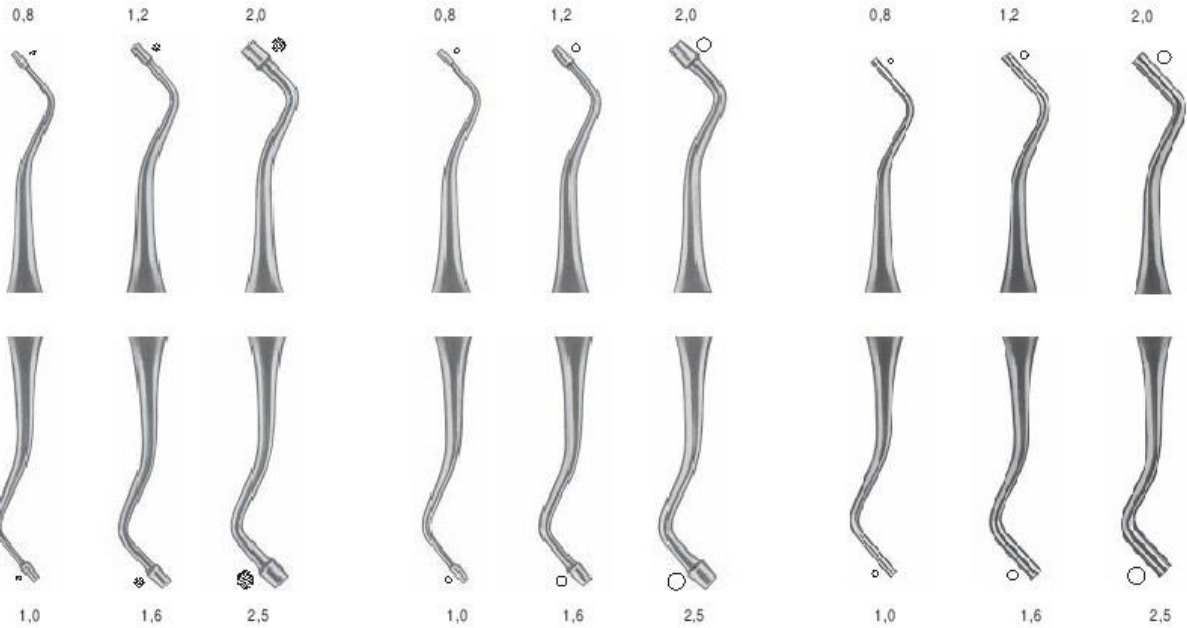

40.3902-8 **40.3902-9** **40.3902-10** **40.3902-18** **40.3902-19** **40.3902-20** **40.3902-29** **40.3902-30** **40.3902-31**
Octo Octo Octo Octo Octo Octo Octo Octo Octo

40.3901-29 **40.3901-30** **40.3901-31**
Rotondo Rotondo Rotondo

40

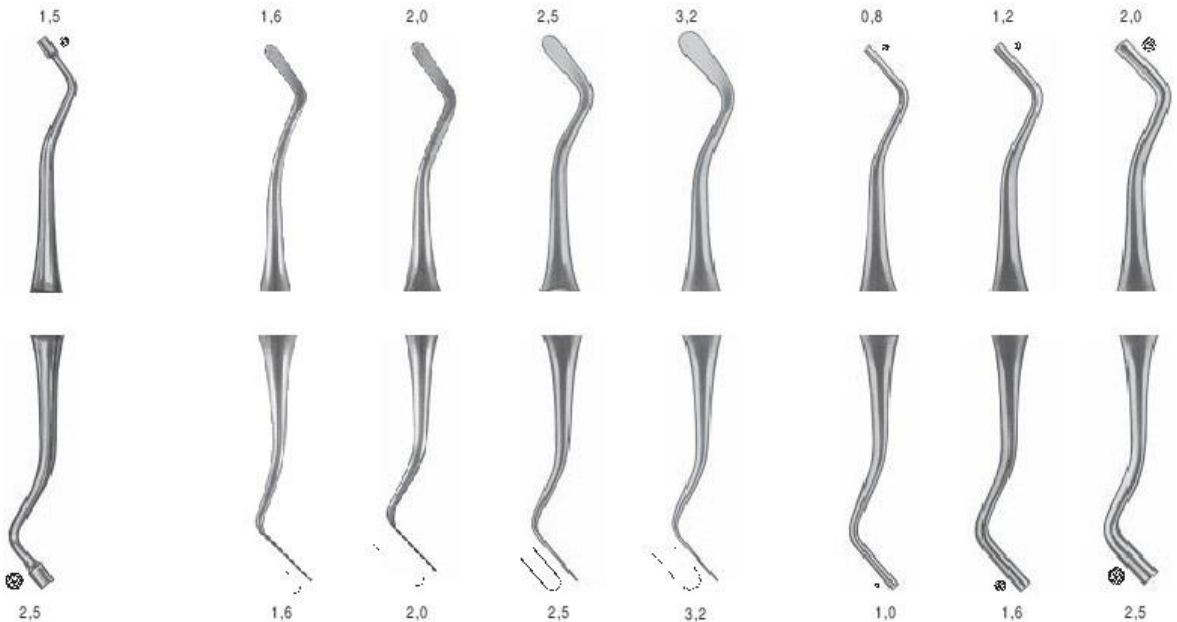

40.3910-1 BLACK **40.3902-15** **40.3902-16** **40.3902-13** **40.3902-14** **40.3902-129** **40.3902-130** **40.3902-131**
Octo, Fig. 153 Octo Octo Octo Octo Octo Octo Octo

40.3911-1 BLACK **40.3901-15** **40.3901-16** **40.3901-13** **40.3901-14**
Rotondo, Fig. 153 Rotondo Rotondo Rotondo Rotondo

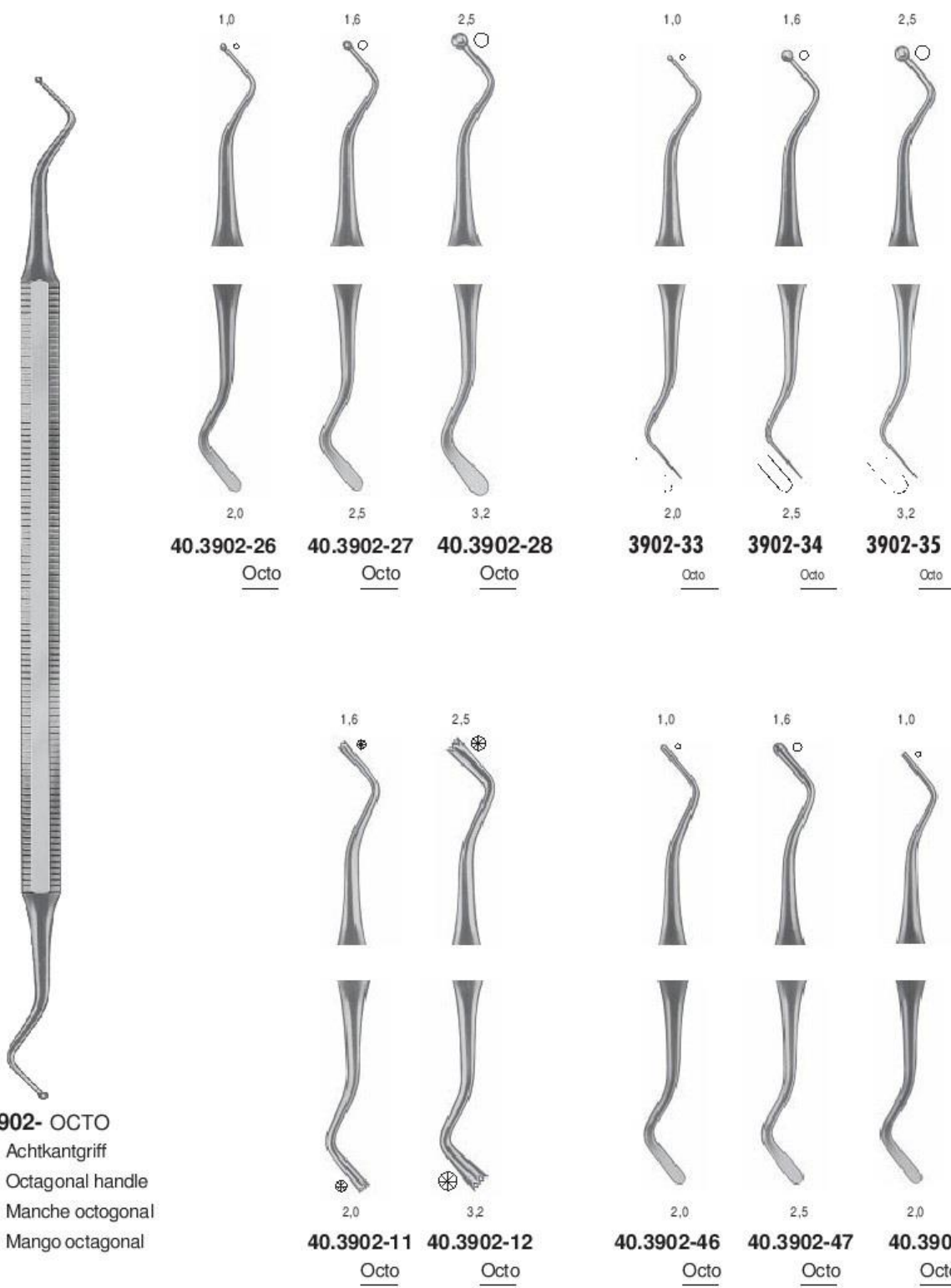

40

40.3902- OCTO
Achtkantgriff
Octagonal handle
Manche octogonal
Mango octogonal

40.3902-26 <u>Octo</u>	40.3902-27 <u>Octo</u>	40.3902-28 <u>Octo</u>	3902-33 <u>Octo</u>	3902-34 <u>Octo</u>	3902-35 <u>Octo</u>
40.3902-11 <u>Octo</u>	40.3902-12 <u>Octo</u>	40.3902-46 <u>Octo</u>	40.3902-47 <u>Octo</u>	40.3902-66 <u>Octo</u>	

40

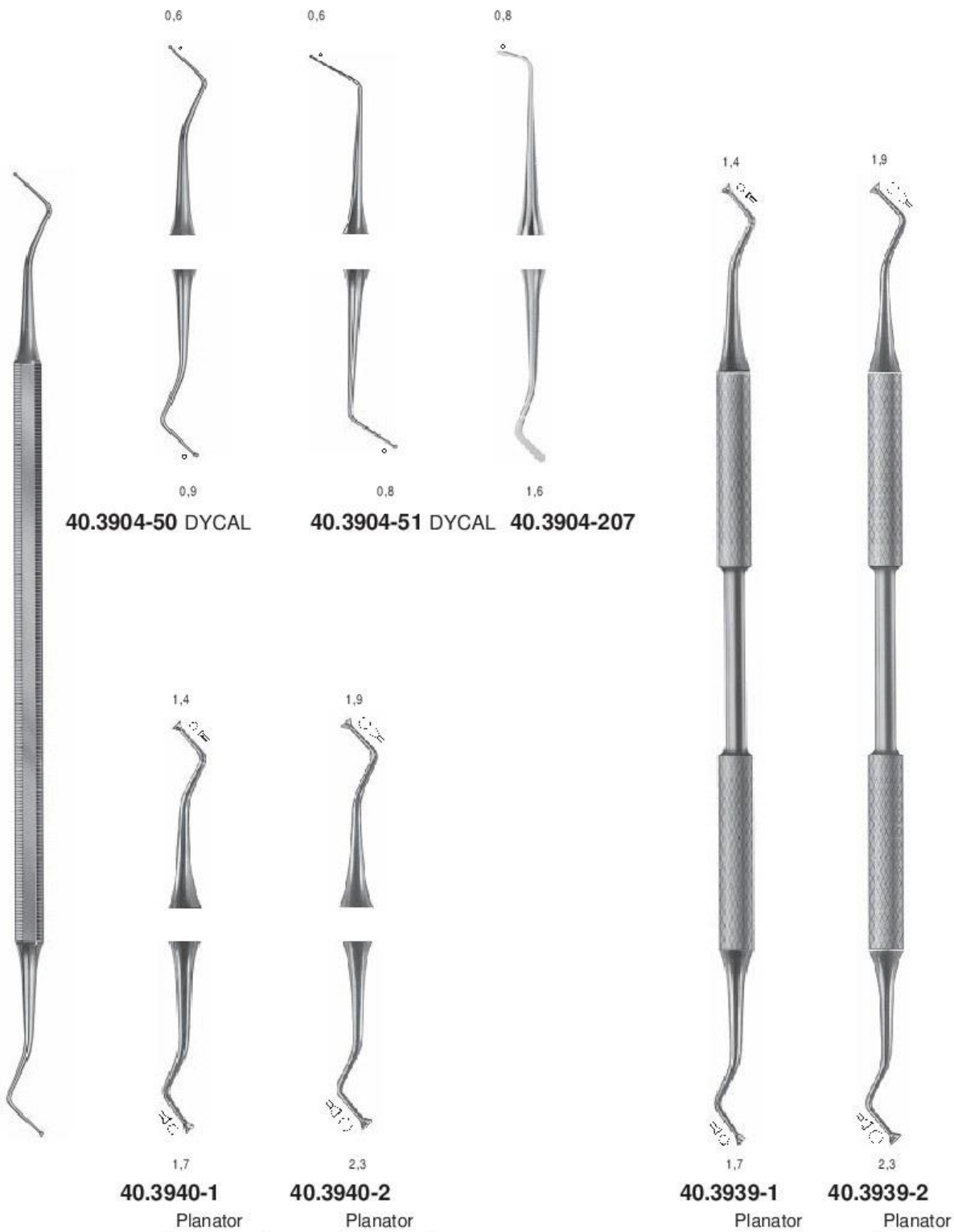

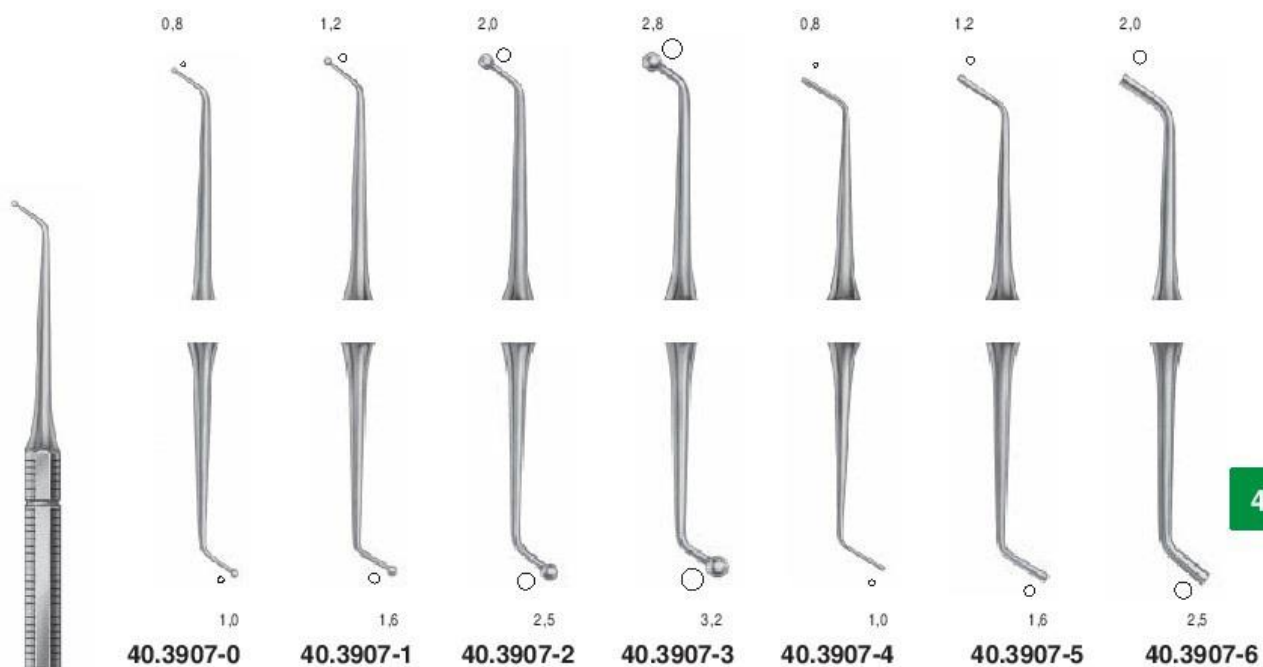

40

Ladmore

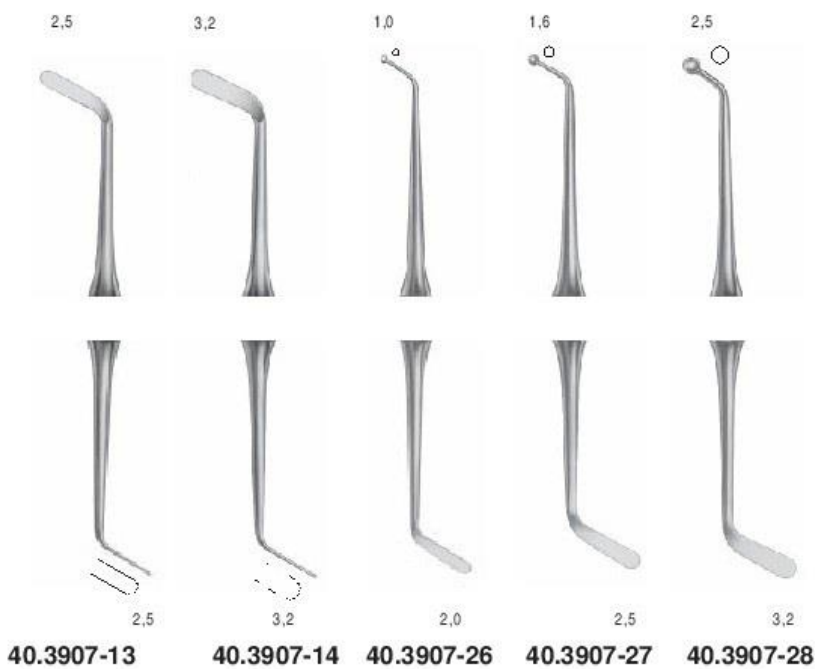

40

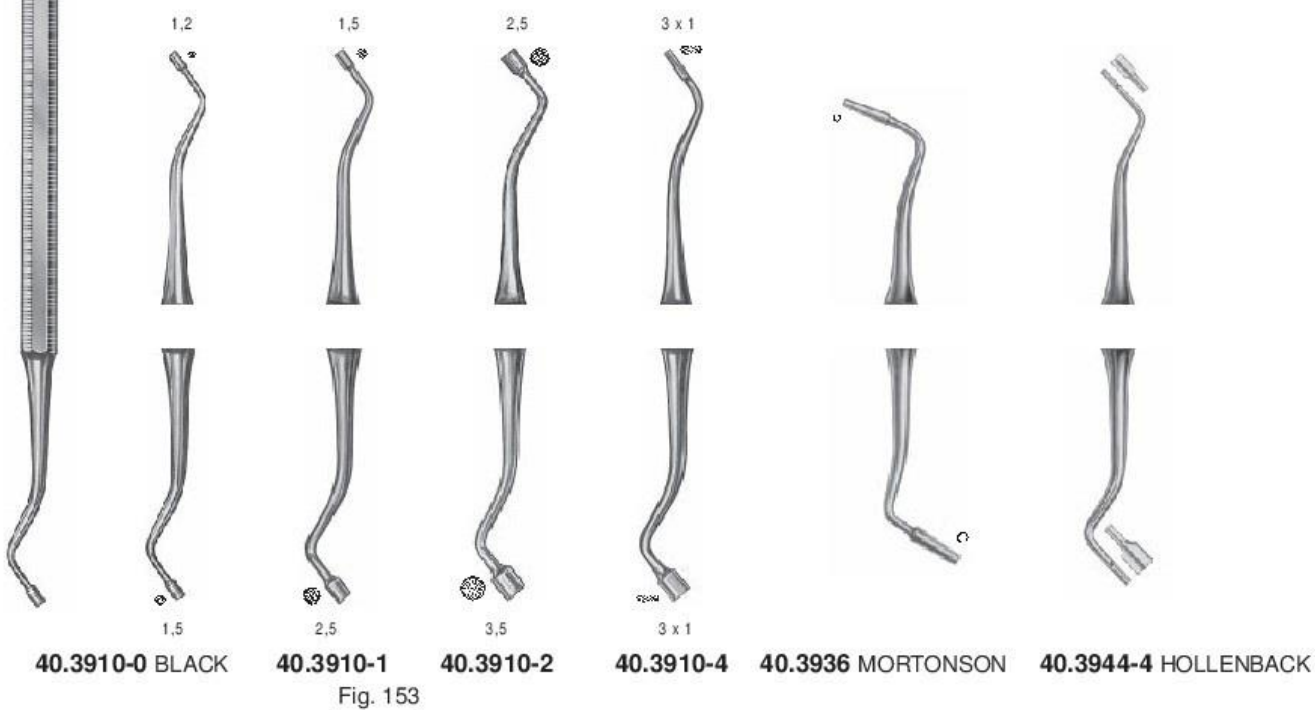
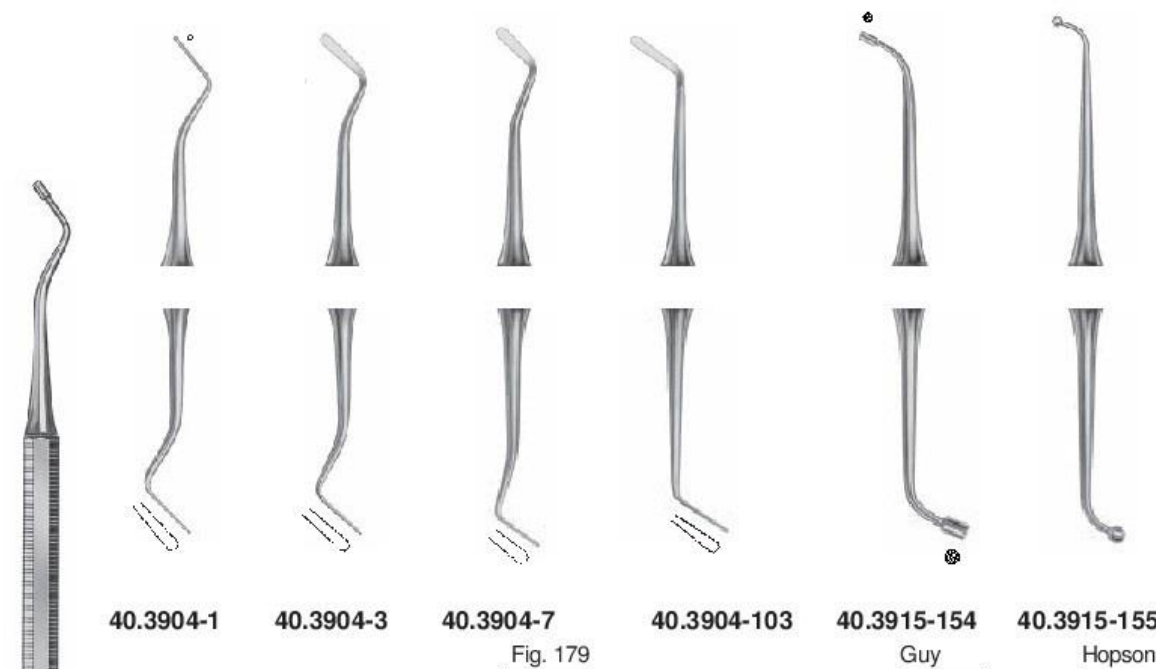

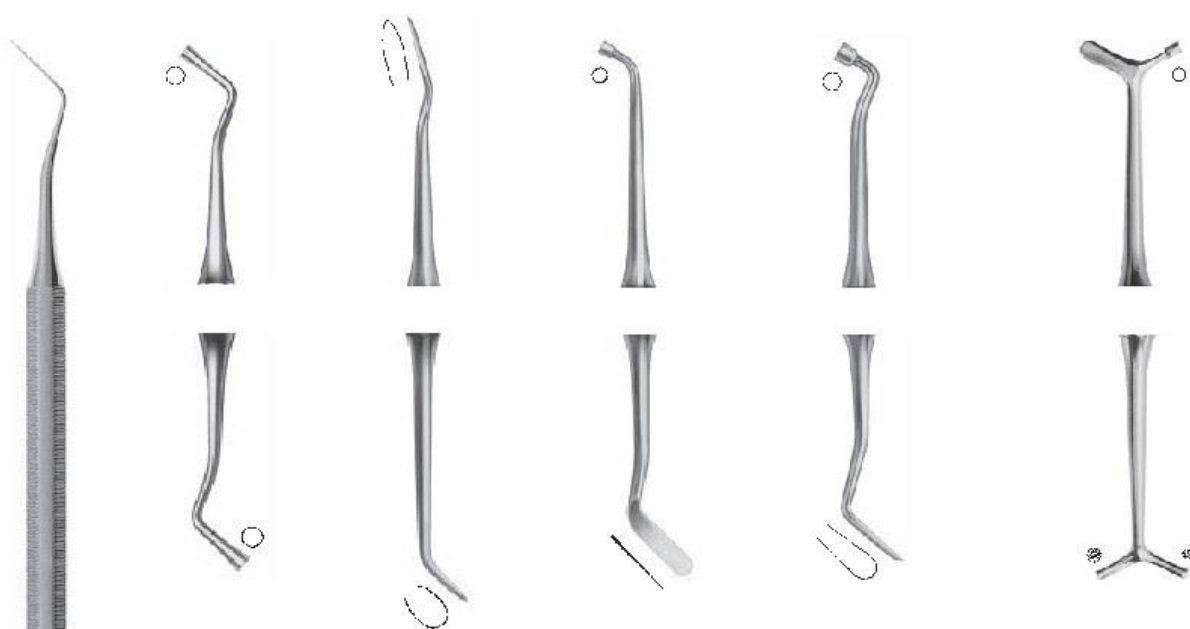

40.3948-2 WARD 40.4000-1 WOODSON 40.4000-2 WOODSON 40.4000-3 WOODSON 40.4082 BENNET

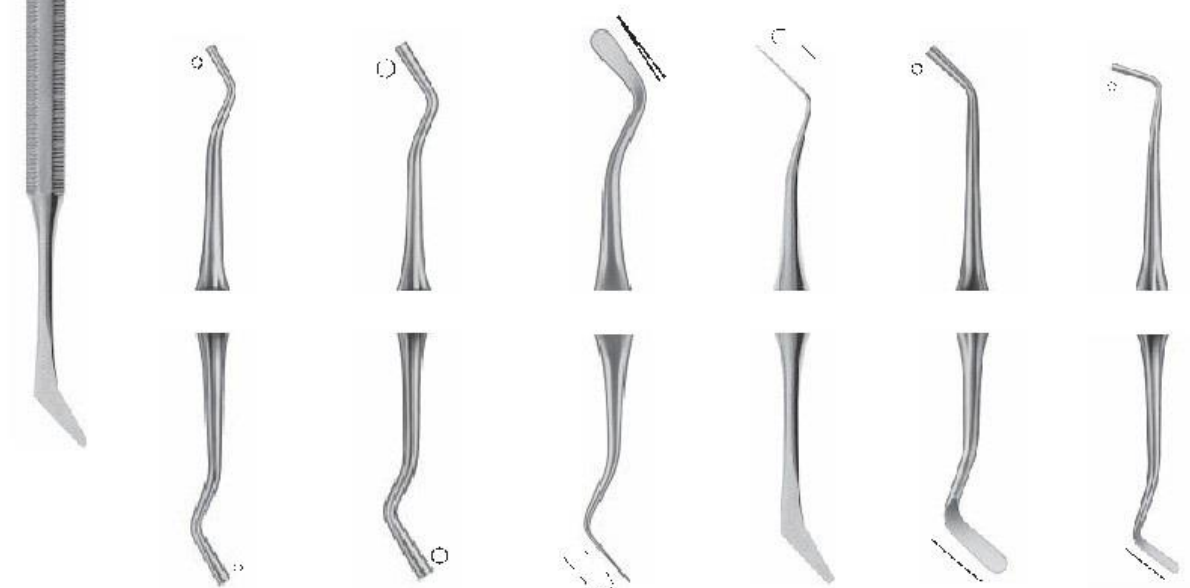

40.4010-1 WILLIAMS 40.4010-2 WILLIAMS 40.3902-14 WILLIAMS 40.4020-1 40.4020-2 Fig. PF2 40.4020-3 Fig. PF3

Starre Spatel
Rigid spatulas
Spatules rigides
Espátulas rígidas

40

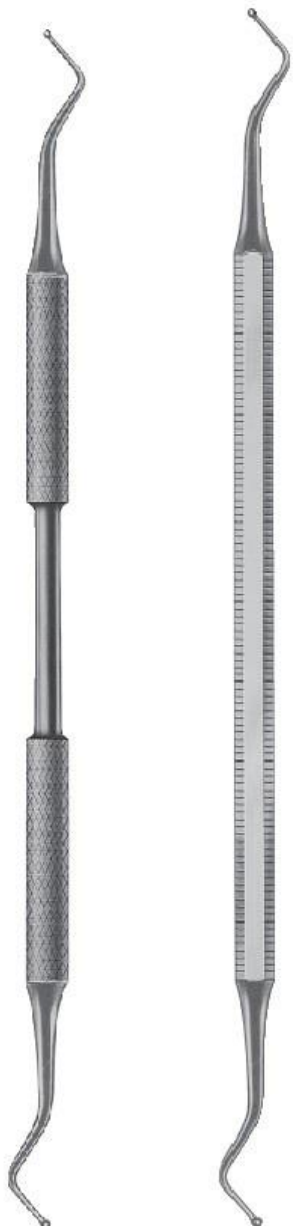

40.3901-ROTONDO
Rundgriff
Round handle
Manche rond
Mango redondo

40.3902-OCTO
Achtkantgriff
Octagonal handle
Manche octogonal
Mango octogonal



40.3902-15 **40.3902-16**
Octo Octo
40.3901-15 **40.3901-16**
Rotondo Rotondo

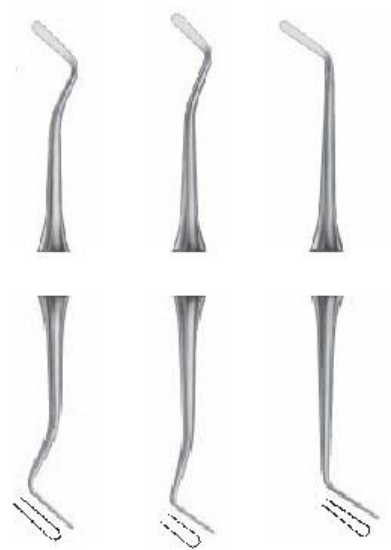

40.3904-3 **40.3904-7** **FIG.179** **40.3904-103**
Octo Octo Octo

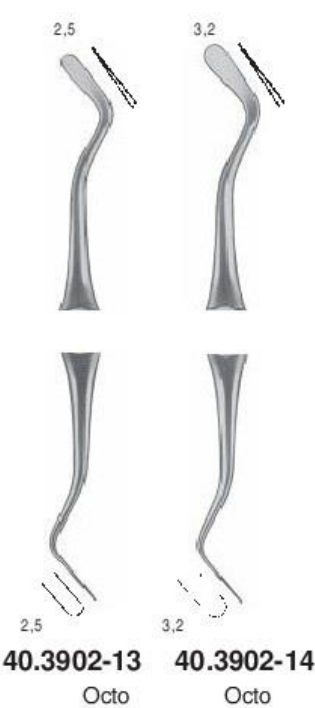

40.3902-13 **40.3902-14**
Octo Octo
40.3901-13 **40.3901-14**
Rotondo Rotondo



40.3907-13 **40.3907-14** **40.4050-4** **FIG.156**
Octo Octo Octo

Flexible Spatel
Flexible spatulas
Spatules flexibles
Espátulas flexibles

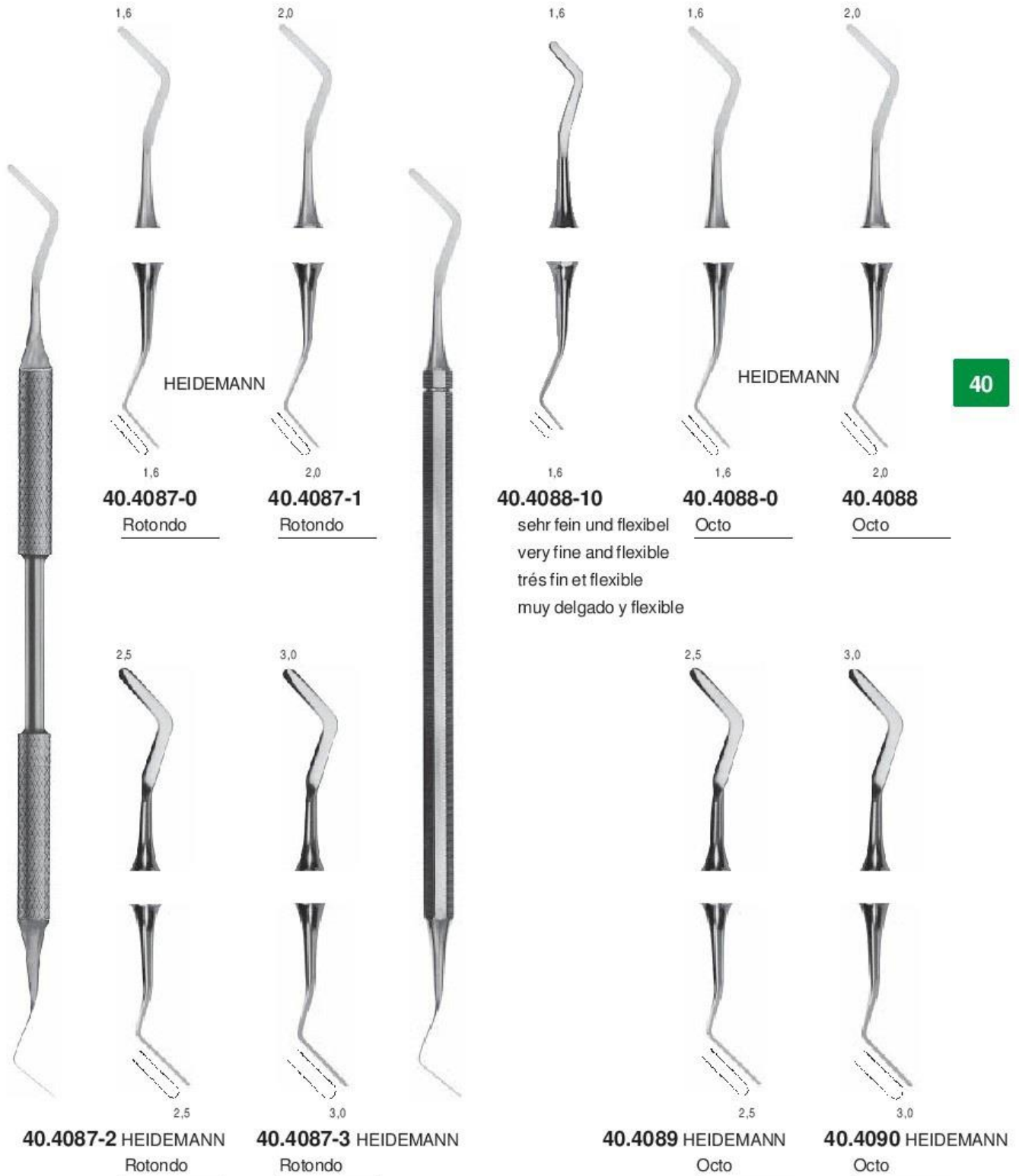

Composite Instrumente
Composite instruments
Instruments pour composite
Instrumentos para composite

40



40.4150-2 TANTAL 40.4150-6 TANTAL



40.4150-8 TANTAL 40.4150-12 TANTAL 40.4150-124 TANTAL



40.4163 TANTAL



40.4146-27 GEURTSSEN
approximal



40.4098
Silberspitzen
Silver points
Pointes d'argent
Puntas de plata

Flexible Spatel
Flexible spatulas
Spatules flexibles
Espátulas flexibles

- ▶ Hochglanzpolierte Arbeitsenden mit TiN-Beschichtung
- ▶ Reduziert Kleben des Composites am Instrument
- ▶ Kein Verfärben der Füllungen

- ▶ Working ends with high mirror polish and TiN-coating
- ▶ Reduces sticking of composite on instrument
- ▶ No discoloration of the composite materials

- ▶ Pointes avec polissage très fin et enduit TiN
- ▶ Réduit l'adhésion du composite sur l'instrument
- ▶ Aucune décoloration des matières composites

- ▶ Puntas con pulimento muy fino y capa TiN
- ▶ Reduzo la adherencia del composite sobre el instrumento
- ▶ Ninguna descoloración de los materiales composite

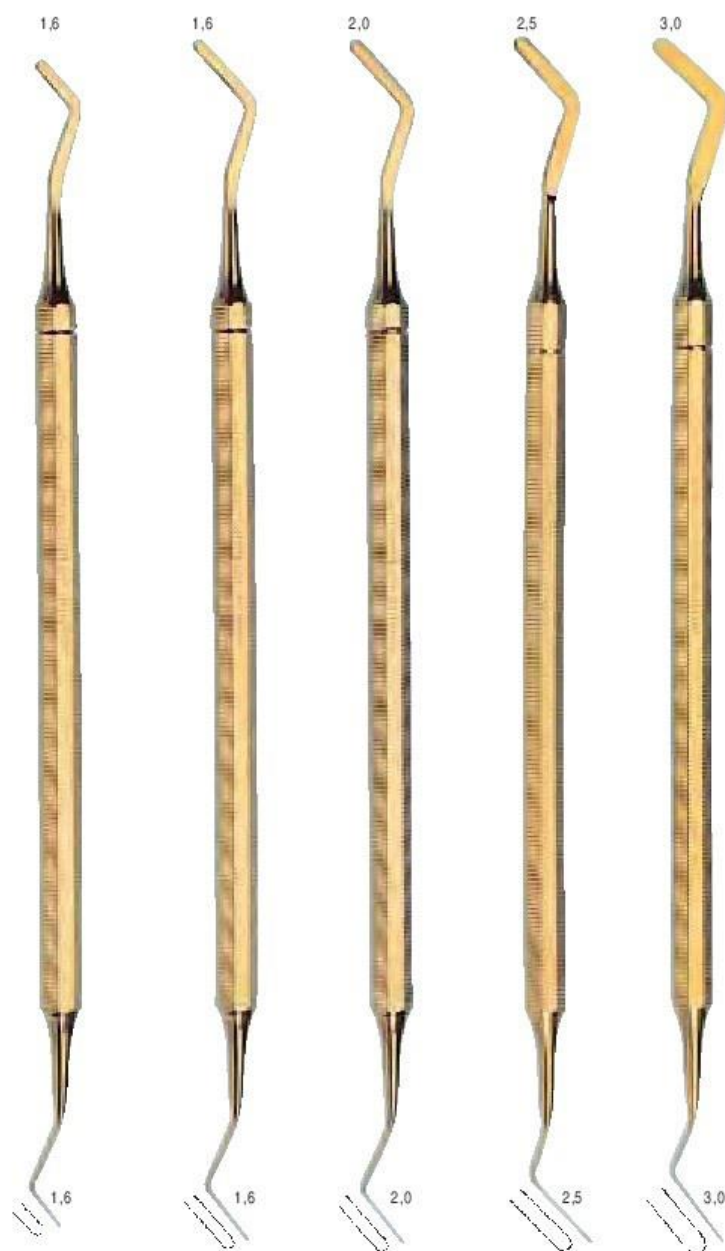

40

40.4086-10 40.4086-0 40.4086-1 40.4086-2 40.4086-3

sehr fein und flexibel
very fine and flexible
trés fin et flexible
muy delgado y flexible

Starre Spatel
Rigid spatulas
Spatules rigides
Espátulas rígido

Füllungsinstrumente
Filling instruments
Instruments pour obturations
Instrumentos para obturaciones

Modellierinstrumente
Carving instruments
Instruments à modeler
Instrumentos para modelar



40.4086-107

40.4086-113



40.4086-101

40.4086-102

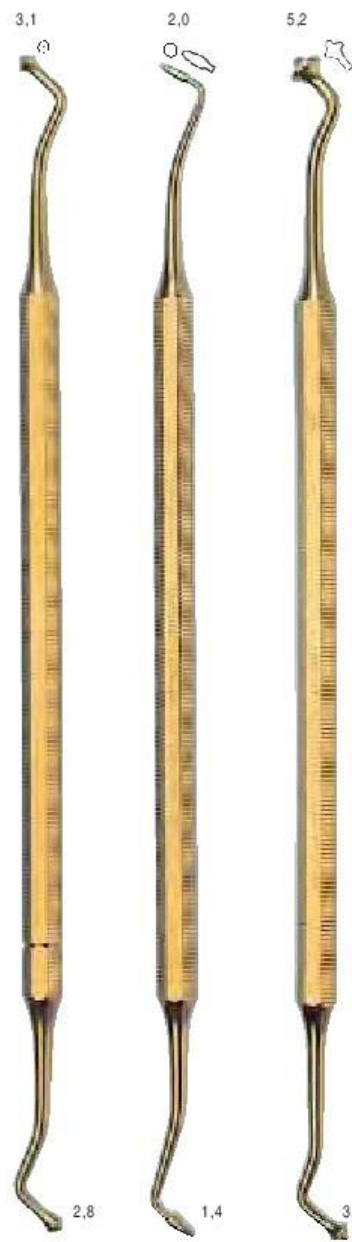

40.4086-122

40.4086-123

40.4086-124

Modellierinstrumente
Carving instruments
Instruments à modeler
Instrumentos para modelar

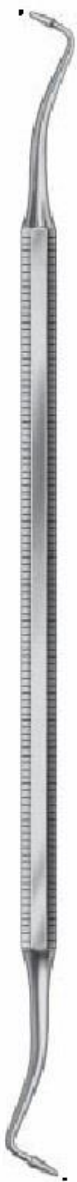

40.4123-3



40.4136 WILAND
occlusal+
approximal



40.4430 HOLLENBACK
Fig. 3



40.4430-15 HOLLENBACK
Fig. 3 S



40.4429-15 HOLLENBACK
Fig. 3 S

Modellierinstrumente
Carving instruments
Instruments à modeler
Instrumentos para modelar

40

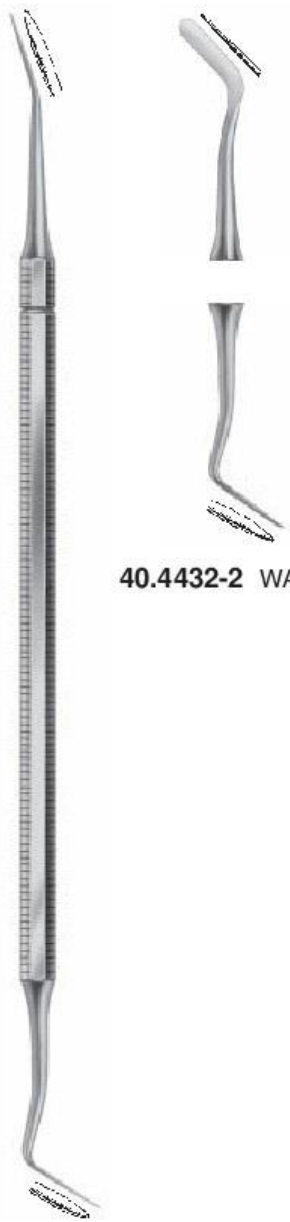

40.4432-2 WARD

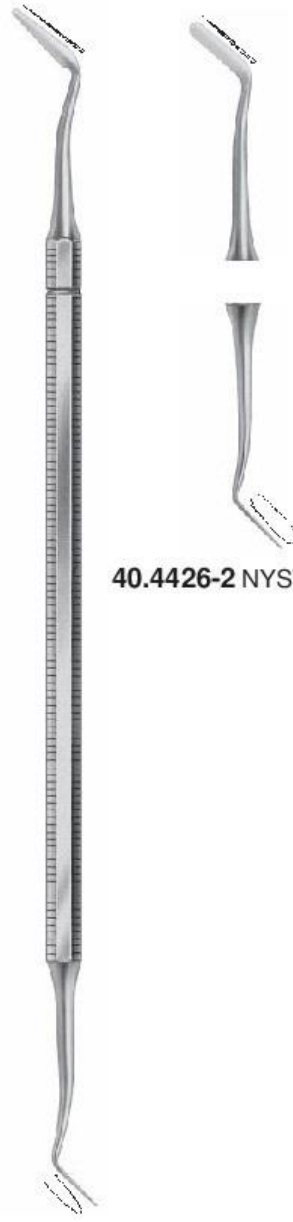

40.4426-2 NYSTRÖM



40.4426-3 NYSTRÖM

40.4432-1 WARD

40.4426-1 NYSTRÖM

Modellierinstrumente
Carving instruments
Instruments à modeler
Instrumentos para modelar

2,0 mm



2,0 mm

40.3452-89 BLACK

Fig. 89/92

discoïd-cleïd

2,0 mm



2,0 mm

40.4134-89 BLACK

Fig. 89/92

discoïd-cleïd

1,5 mm



1,5 mm

40.4134-12

discoïd-cleïd

2,3 mm



2,8 mm

40.4134-36

Fig. WACD

2,0 mm



2,0 mm

40.4134-110

Modellierinstrumente
Carving instruments
Instruments à modeler
Instrumentos para modelar

40

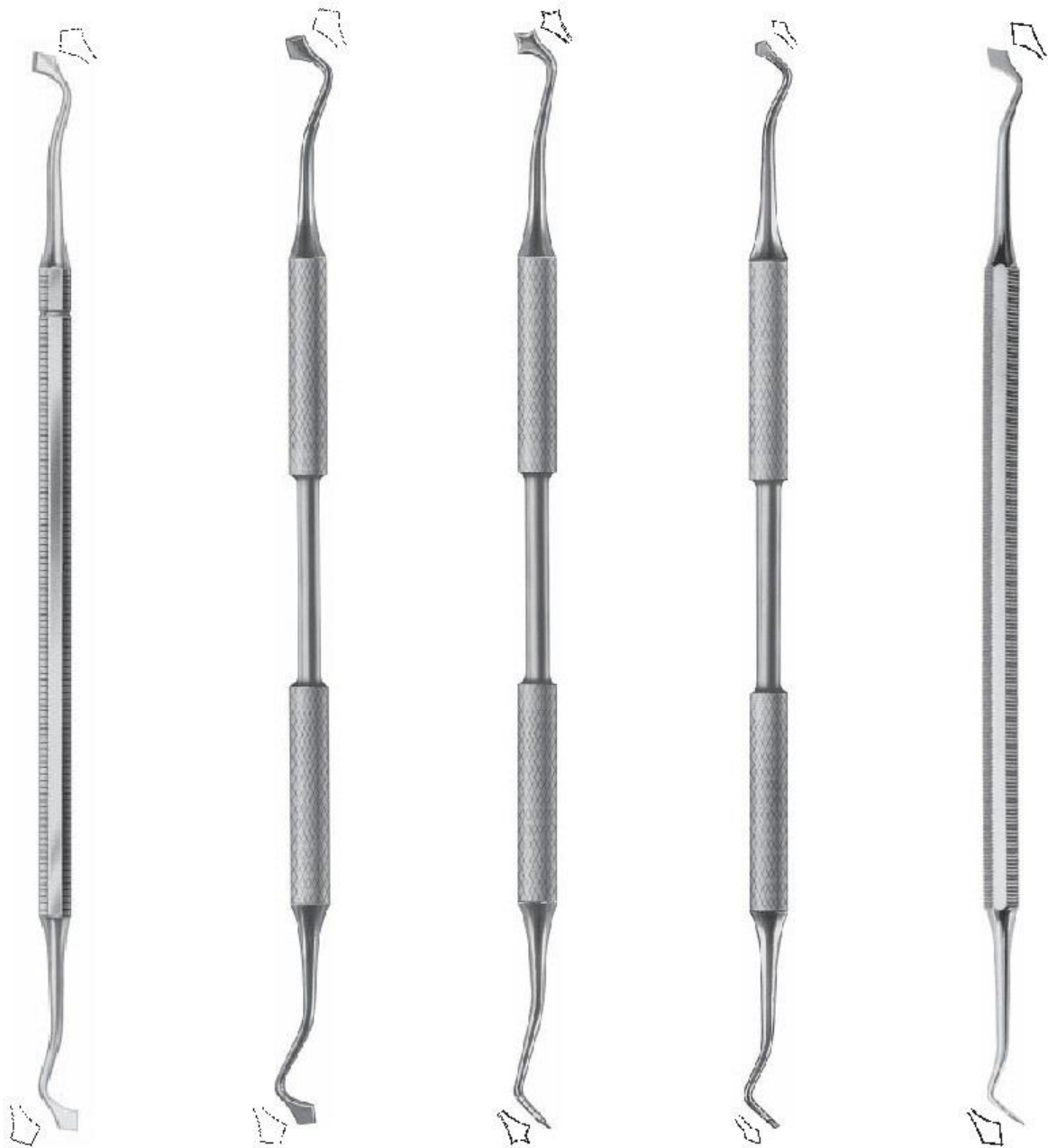

40.4454 FRAHM

45°

40.4127-1 FRAHM

45°

40.4127-10 VIGNON

40.4127-3

40.4124

Fig. H

Polierer
Burnishers
Brunissoires
Bruñidores



40.4121 WESTCOTT
Fig. 21



40.4122 WESTCOTT
Fig. 21B



40.4123
Fig. J



40.4126-1 WESTCOTT

40

Polierer
Burnishers
Brunissoires
Bruñidores

40



40.4126-10



40.4126-20 ROMEROWSKI



40.4133-2729

Fig. 27/29



40.4133-28D

Fig. 28/29

Zementspatel
Cement spatulas
Spatules à ciment
Espátulas para cemento



40.4325

flexibel
flexible
flexible
flexible



40.4327



40.4333

Achat
Agate
Agate
Agata



40.4310

40

40



40.4340



40.4342-1



40.4342-2



40.4342-3

Fig. 8

Kofferdam
Rubber dam
Digue de caoutchouc
Dique de goma

40.3562

Kofferdam-Halter
Rubber dam holder
Porte-digues
Sostenedor

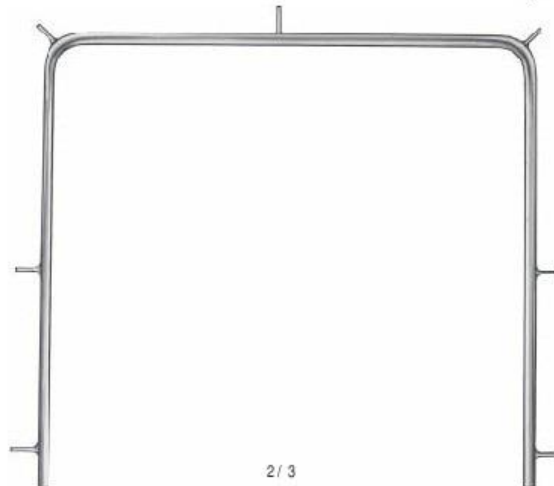

2 / 3

40



2 / 3

40.3550 AINSWORTH

17 cm, Lochzangen
17 cm, punch forceps
17 cm, pinces à perforer
17 cm, perforadores



2 / 3

40.3552 IVORY

16 cm, Lochzangen
16 cm, punch forceps
16 cm, pinces à perforer
16 cm, perforadores

Kofferdam
Rubber dam
Digue de caoutchouc
Dique de goma

40



2 / 3

40.3554

18 cm, Klammerzangen
18 cm, clamp forceps
18 cm, pinces porte-crampons
18 cm, portaclamps



2 / 3

40.3555 STOKES

17 cm, Klammerzangen
17 cm, clamp forceps
17 cm, pinces porte-crampons
17 cm, portaclamps



2 / 3

40.3557 BREWER

18 cm, Klammerzangen
18 cm, clamp forceps
18 cm, pinces porte-crampons
18 cm, portaclamps

Wurzelkanalinstrumente
Root canal instruments
Instruments radiculaires
Instrumentos radiculares



40.3078
Wurzelkanal-Sonde
Explorer for root canal
Sonde pour le canal
Sonda para el canal



40.3463-49
Ø 1,3 mm, Exkavator
Ø 1,3 mm, Excavator
Ø 1,3 mm, Excavateur
Ø 1,3 mm, Excavadore



40.3463-50
Ø 1,0 mm, Exkavator
Ø 1,0 mm, Excavator
Ø 1,0 mm, Excavateur
Ø 1,0 mm, Excavadore



40.4937 IVORY
Stiftzieher
Post puller
Instrument pour enlever les pivots
Removedor de los pivotes

40

Wurzelkanal-Spreizer
Root canal spreaders
Fouloirs latéraux
Condensadores laterales

40

0,3 mm



40.3620-03

0,4 mm



40.3620-04

0,5 mm



40.3620-05

0,6 mm



40.3620-06



40.3620-115

Zur Wärmeübertragung
Heat transmitter
Pour transmettre chaleur
Para transmitir el calor

Wurzelkanal-Stopfer
Root canal pluggers
Fouloirs à canaux
Obturadores radiculares

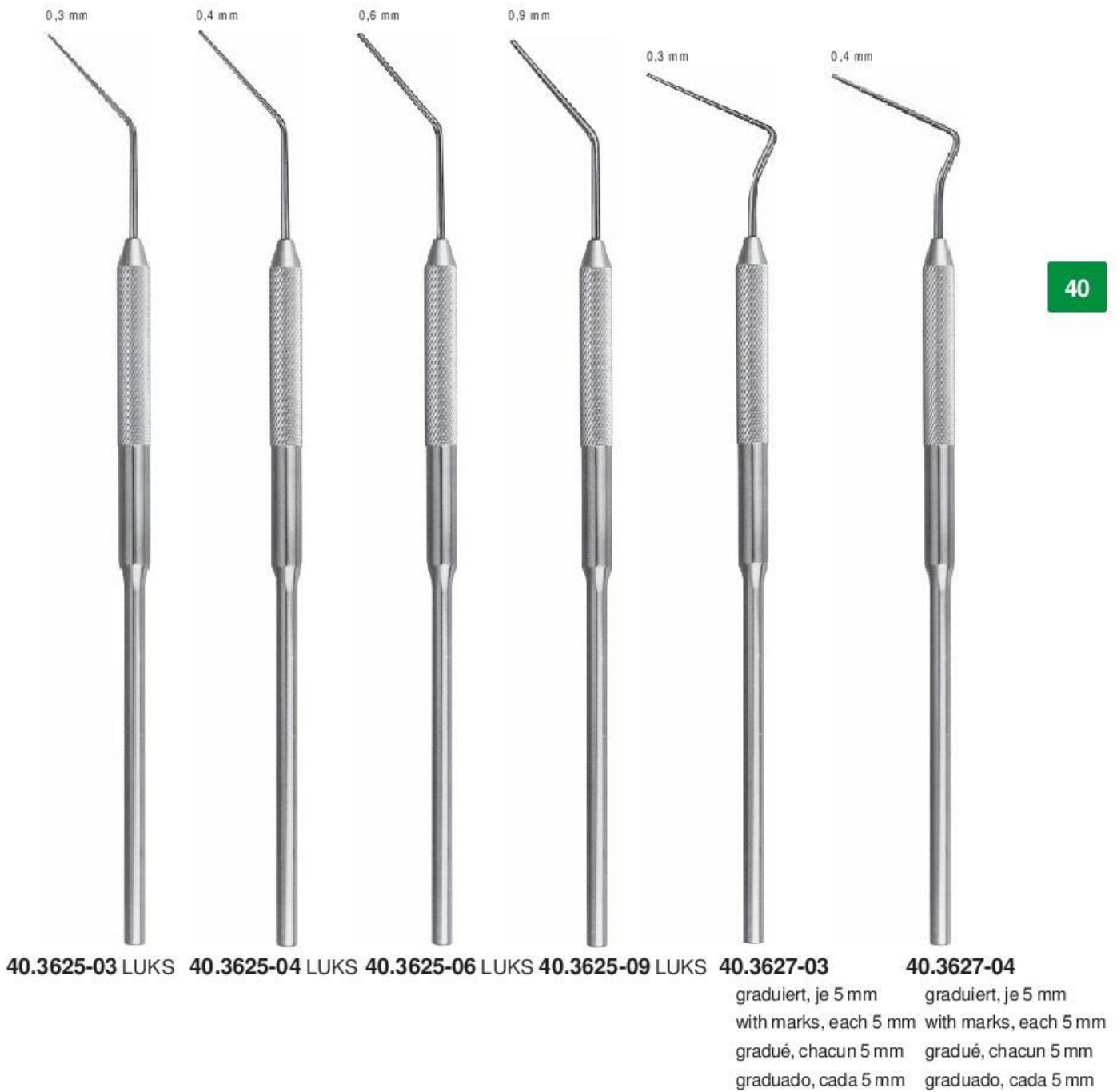

40

Wurzelkanal-Stopfer
Root canal pluggers
Fouloirs à canaux
Obturadores radiculares

40



40.3627-06

graduert, je 5 mm
with marks, each 5 mm
gradu , chacun 5 mm
graduado, cada 5 mm

40.3627-09

graduert, je 5 mm
with marks, each 5 mm
gradu , chacun 5 mm
graduado, cada 5 mm

40.3632-1 GLICK

40.3630-1

40.3630-2

40.3630-3



40.2908

Pinzetten für Silberspitzen
Silver points forceps
Pincés pour cônes d'argent
Pinzas para puntas de plata



40.2988

mit Schloß
with ratchet
avec arrêt
con cremallera



40.3661

für Wurzelstifte
for root pins
pour cônes radiculaires
para punta radicales



41

**PROTHODONTIA /
ORTHODONTIA**

**PROTHETIK /
ORTHODONTIE**

**PROTHÉSE /
ORTHODONTIE**

**PROTODONCIA /
ORTODONCIA**

Modellierinstrumente
Carving instruments
Instruments à modeler
Instrumentos para modelar

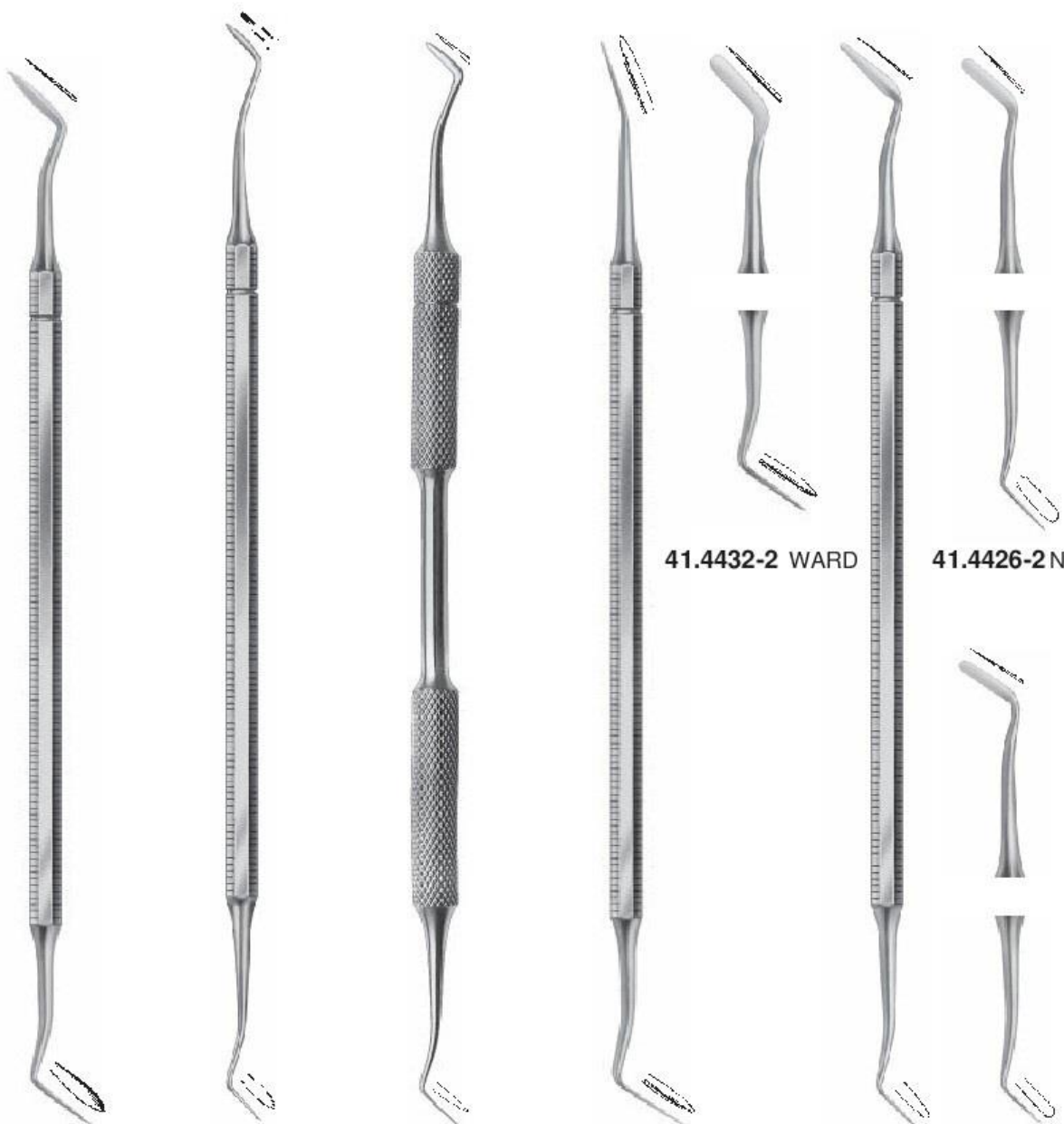

41.4430 HOLLENBACK
Fig. 3

41.4430-15
Hollenback, Fig. 3 S

41.4429-15
Hollenback, Fig. 3 S

41.4432-1 WARD

41.4432-2 WARD

41.4426-1 NYSTRÖM

41.4426-2 NYSTRÖM

41.4426-3

Modellierinstrumente
Carving instruments
Instruments à modeler
Instrumentos para modelar

41



41.4422 HYLIN

41.4421 ZAHLE

41.4441 ZAHLE

41.4444

41.4446 HYLIN-LE CRON

41.4447

41.4449

Modellierinstrumente
Carving instruments
Instruments à modeler
Instrumentos para modelar

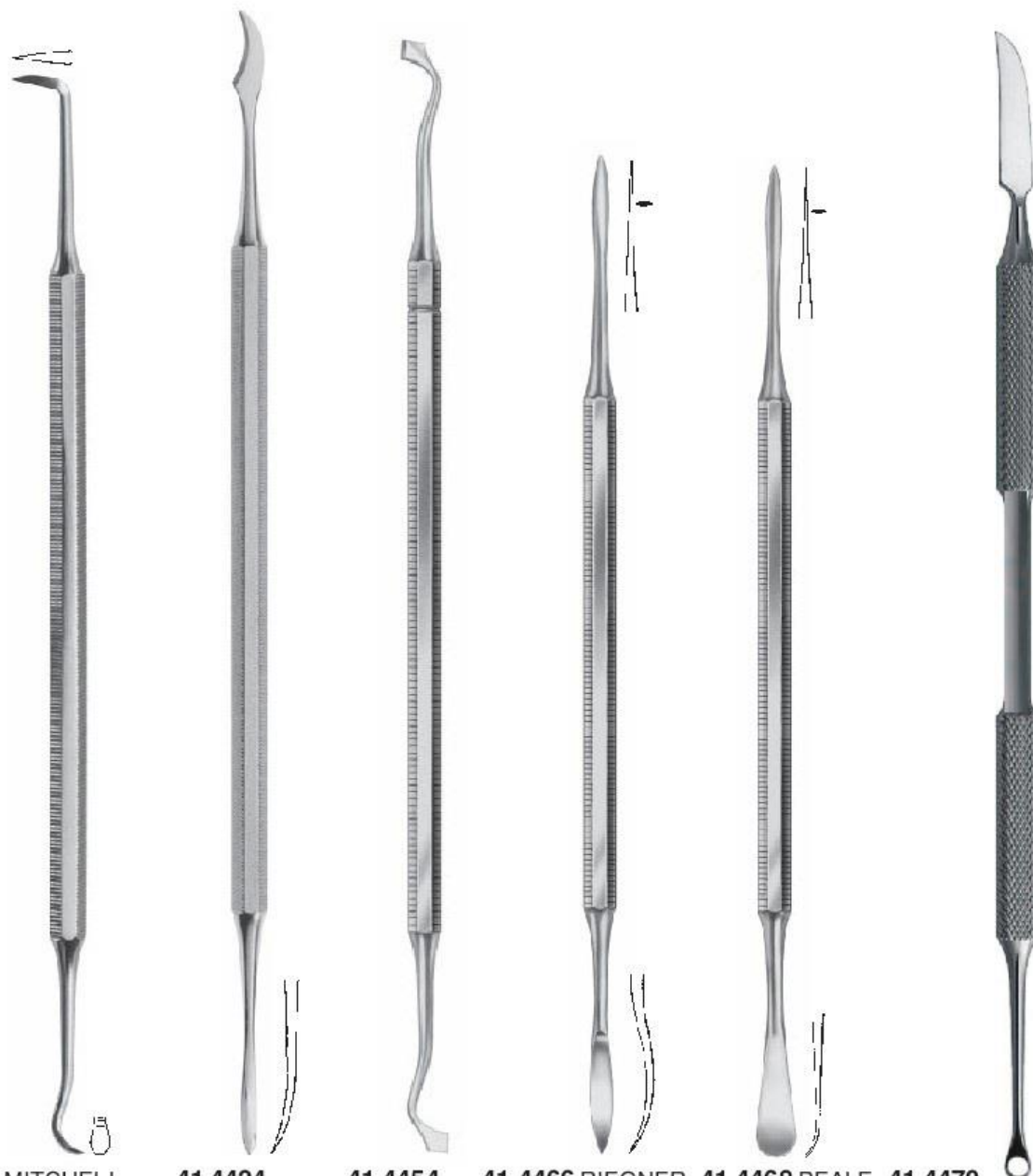

41.3254 MITCHELL

41.4424

41.4454
FRAHM

41.4466 RIEGNER

41.4468 BEALE

41.4470

Silikonmesser mit schneidender Öse
Silicone knife with cutting ring
Couteau à silicone
Cuchillo del silicón

41

Für Aufwachstechnik
For waxing-on technique
Pour la technique de moulage à cire
Para modelar en la técnica cerera

41



41.4480-1 P.K. THOMAS
Fig. 1



41.4480-2 P.K. THOMAS
Fig. 2



41.4480-3 P.K. THOMAS
Fig. 3



41.4480-4 P.K. THOMAS
Fig. 4



41.4480-5 P.K. THOMAS
Fig. 5



41.2913 PERRY

41.2631

120 ccm, Spirituslampe
120 ccm, alcohol lamp
120 ccm, lampe à alcool
120 ccm, lámpara de alc



41.6070

16 cm, Lötpinzette isoliert
16 cm, soldering tweezer insulated
16 cm, pince isolée
16 cm, pinza aislada para soldar



41.6241

23 cm, Niethammer
23 cm, riveting mallet
23 cm, marteau à river
23 cm, martillo para remachar



41.6245

22 cm, Hornhammer
22 cm, horn mallet
22 cm, maillet de corne
22 cm, mazo de cuerno



41.4501 ERMERT

12 cm



41.4502 ERMERT

14 cm

41

Wachsmesser
Wax knives
Couteaux à cire
Cuchillos para cera

41

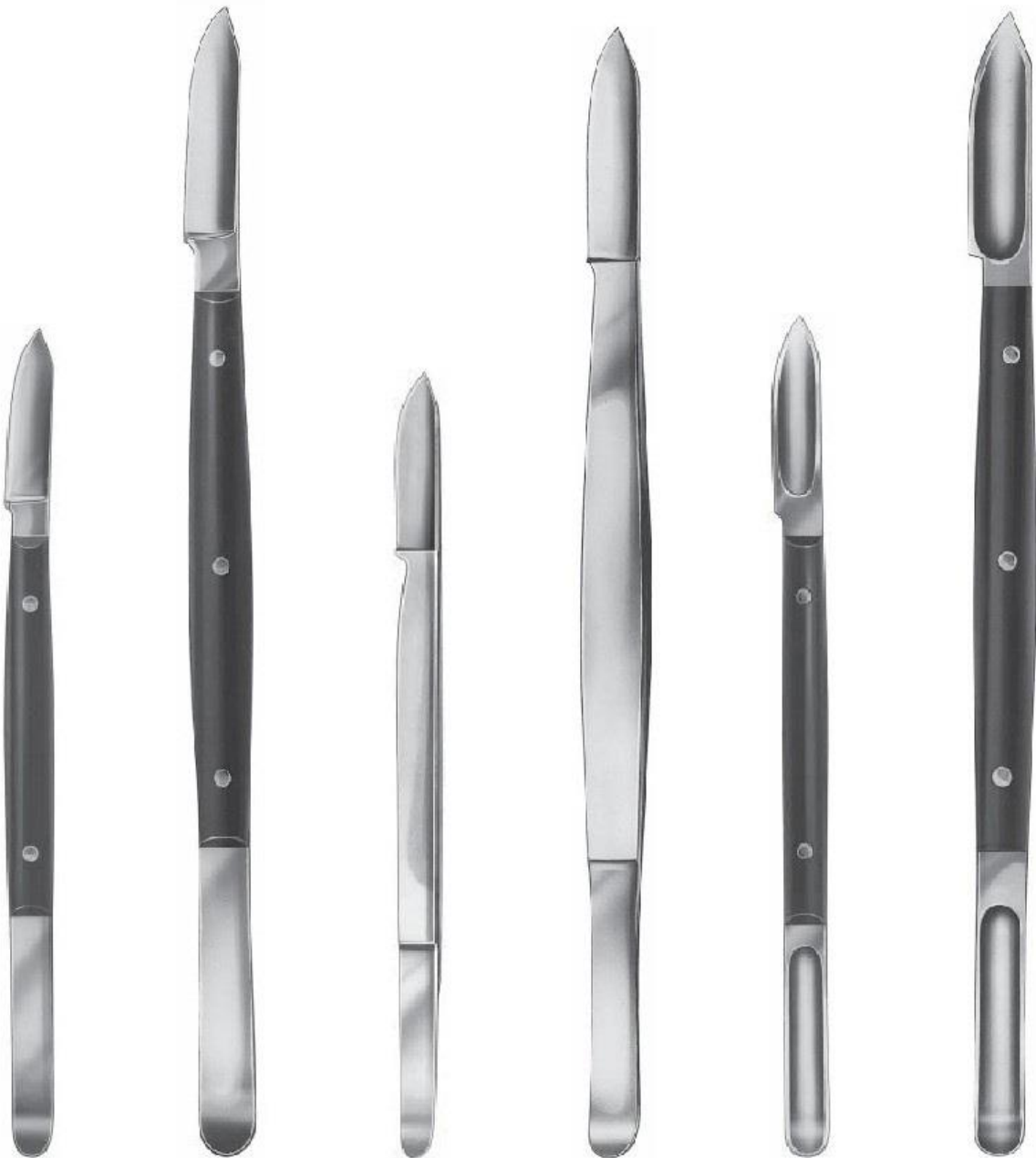

41.4510 FAHNEN-STOCK
13 cm

41.4512 FAHNEN-STOCK
17 cm

41.4516
12 cm

41.4517
17 cm

41.4520 LESSMANN
13 cm

41.4522 LESSMANN
17 cm

Gipsmesser
Plaster knives
Couteaux à plâtre
Cuchillos para yeso



41.4540
18 cm



41.4542 GRITMANN
16 cm



41.4545
18 cm



41.4546
15 cm



41.4558
20 cm, Gipsschneidezange
20 cm, plaster cutting pliers
20 cm, pince à couper plâtre
20 cm, alicata para cortar yeso

Spatel für Abdruckmasse
Spatulas for impression materials
Spatules pour matériaux d'empreintes
Espátulas para materiales de impresión

41



41.4560

19 cm, sehr flexibel
19 cm, very flexible
19 cm, très flexible
19 cm, muy flexible

41.4562

22 cm

41.4565

21 cm

41.4570 LICHTENSTEIN

17 cm

41.4571

20 cm

Kronen- und Blehscheren
Crown and plate scissors
Ciseaux à couronnes et tôle
Tijeras para coronas y planchas



2/3

41.4862

12 cm, gezahnt
12 cm, saw edge
12 cm, dentelés
12 cm, dentadas

41.4863 TC GOLD

12 cm, Hartmetalleinsätze
12 cm, tungsten carbide insert
12 cm, pointes en tungstène
12 cm, puntas de tungsteno



2/3

41.4869

10 cm, gebogen
10 cm, curved
10 cm, courbes
10 cm, curvas



2/3

41.4865

10,5 cm, gebogen
10,5 cm, curved
10,5 cm, courbes
10,5 cm, curvas

41



2/3

41.4821 BEEBEE

10,5 cm, spitz, gerade
10,5 cm, sharp, straight
10,5 cm, pointus, droits
10,5 cm, agudas, rectas



2/3

41.4825 BEEBEE

spitz, gebogen
sharp, curved
pointus, courbes
agudas, curvas



2/3

41.4841

12 cm, gerade, gezahnt
12 cm, straight, saw edge
12 cm, droits, dentelés
12 cm, rectas, dentadas



2/3

41.4845

gebogen, gezahnt
curved, saw edge
courbes, dentelés
curvas, dentadas

Kupferringabnehmezange
Copper ring removing pliers
Pince à enlever les bagues en cuivre
Pinza para sacar anillos de cobre

Retraktionsfadenstopfer
Gingival cord packer
Pour fil retracteur
Para hilo retractor

41



41.4946 FURRER

15 cm



41.4880-1

gezahnt
saw edge
dentelés
dentadas



41.4880-2

gezahnt
saw edge
dentelés
dentadas



41.4880-3 UNIVERSAL

45°, gezahnt
45°, saw edge
45°, dentelés
45°, dentadas



41.4890 MILLER

Artikulationspapierpinzette
Forceps for articulating paper
Pince pour papier à articuler
Pinza para papel de articular



41.4937 IVORY

Stiftzieher
Post puller
Instrument pour enlever les pivots
Removedor de los pivotes



41.4892

Tasterzirkel
Caliper
Compas d'épaisseur
Calibre



IWANSON

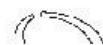

41.4894 IWANSON

10 cm, Zehntelmaß
10 cm, decimal caliper
10 cm, calibre décimal
10 cm, calibrador decimal

41

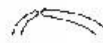

41.4894-1 IWANSON

10 cm, für Wachs
10 cm, for wax
10 cm, pour cire
10 cm, para cerera

Kronenabnehmer
 Crown removers
 Instruments à détacher les couronnes
 Instrumentos para quitar coronas

41

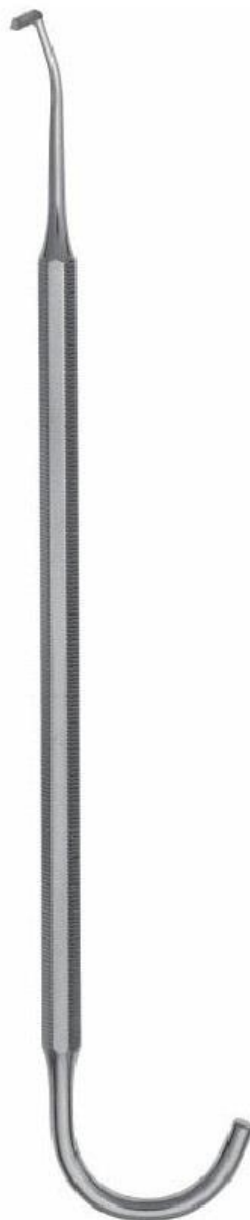

41.4920 TREYMANN



41.4924-1 41.4924-2 41.4924-3

41.4924 MORELL

mit Ansätzen Nr. 41.4924-1 + 41.4924-2
 with tips No. 41.4924-1 + 41.4924-2
 avec pointes No. 41.4924-1 + 41.4924-2
 con puntas No. 41.4924-1 + 41.4924-2

41.4924-10 MORELL

komplett mit 3 Ansätzen
 complete with 3 tips
 complet avec 3 pointes
 completo con 3 puntas



41.4925 MORELL

mit Ansätzen Nr. 41.4924-1 + 41.4924-2
 with tips No. 41.4924-1 + 41.4924-2
 avec pointes No. 41.4924-1 + 41.4924-2
 con puntas No. 41.4924-1 + 41.4924-2

41.4925-10 MORELL

komplett mit 3 Ansätzen
 complete with 3 tips
 complet avec 3 pointes
 completo con 3 puntas

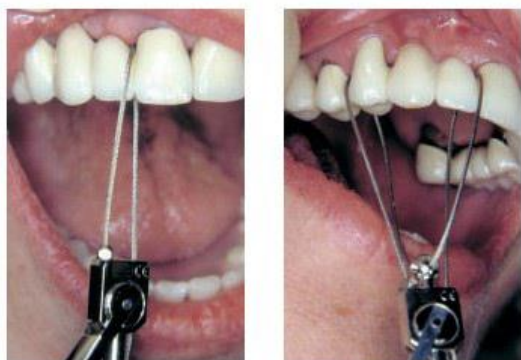

Kronenabnehmer Lift-ex
Crown removers Lift-ex
Instruments à détacher les couronnes Lift-ex
Instrumentos para quitar coronas Lift-ex



41.4924-21 SINGLE-LOOP TIP

Set mit 1 Single-Loop Tip, Adapter und Schlüssel
Set with 1 Single-Loop Tip, adapter and key
Ensemble avec 1 Single-Loop Tip, adaptateur et clé
Sistema con 1 Single-Loop Tip, adaptador y llave

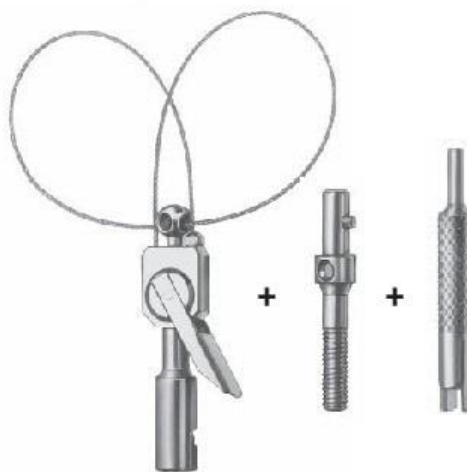

41.4924-22 DOUBLE-LOOP TIP

Set mit 1 Single-Loop Tip, Adapter und Schlüssel
Set with 1 Single-Loop Tip, adapter and key
Ensemble avec 1 Single-Loop Tip, adaptateur et clé
Sistema con 1 Single-Loop Tip, adaptador y llave

41



41.4924-26

Adapter
Adapter
Adaptateur
Adaptador



41.4924-25

Schlüssel
Key
Clé
Llave



41.4924-31

Ersatzschlaufe f. Single-Loop Tip
Spare loop for Single-Loop Tip
Boucle disponible pour Single-Loop Tip
Lazo de repuesto por Single-Loop Tip

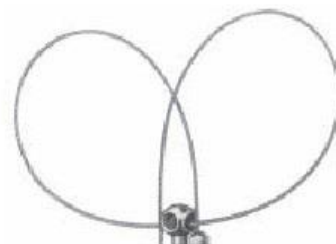

41.4924-32

Ersatzschlaufe f. Double-Loop Tip
Spare loop for Double-Loop Tip
Boucle disponible pour Double-Loop Tip
Lazo de repuesto por Double-Loop Tip

Kronenabnehmer

Crown removers

Instruments à détacher les couronnes

Instrumentos para quitar coronas

41



41.3100-1



41.4927 UNIVERSAL

1-8



41.4928

1-3



41.4929

4-8



41.4943 TC GOLD

Kronenabnehmezangen
Crown trial forceps
Pincès pour couronnes en ceramique
Alicates para coronas cerámicas

41.4940-100

1 Paar Kunststoffbacken

1 pair of inserts

1 paire de protecteurs

1 pareja de capas



41.4940-17

☺ 13 - 18, 23 - 28



41.4940-22

☺ 33 - 38, 43 - 48



41.4940-217

☺ 3 - 8

Amerikanische Form
American pattern
Modèle américain
Modelo americano

Teleskopkronenzangen
Pliers for telescope crowns
Pincès pour couronnes telescopes
Alicates para coronas telescópicas

41.4947-6

- 1 Paar Ersatzspitzen
- 1 pair of replacement tips
- 1 paire de pointes de rechange
- 1 pareja de puntas de recambio

41



41.4947 BÖHM
15 cm



41.4947-2 BÖHM
13 cm, fein
13 cm, fine
13 cm, gracile
13 cm, grácil



41.4947-5
13,5 cm, diamantierte Spitzen
13,5 cm, diamonded tips
13,5 cm, pointes diamantées
13,5 cm, puntas diamantadas



- ▶ verbesserte Form - hervorragende Retention des Abdruckmaterials durch einen durchgehend anliegenden Rand-schlußbügel
- ▶ hygienisch, da leicht zu reinigen, zu desinfizieren und zu sterilisieren
- ▶ Material: rostfreier Edelstahl 18/8
- ▶ resistent gegen mechanische, thermische und chemische Einwirkungen (einschl. Ultraschall)

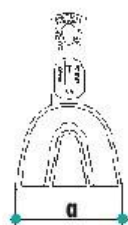

	a		
	+ / - 1,5 mm		
41.4975-111	64 mm	SUP 1	
41.4975-112	66 mm	SUP 2	
41.4975-113	70 mm	SUP 3	
41.4975-114	72 mm	SUP 4	
41.4975-115	79 mm	SUP 5	

Oberkiefer
Upper jaw
Maxillaire
Maxilar

- ▶ improved design - excelent retention of impression materials by a super retention rim-bow

41

- ▶ hygienically, easy to clean, disinfect and sterilize
- ▶ material: stainless steel 18/8
- ▶ resistant against mechanical, thermic and chemical impacts (including ultrasonic cleaning)

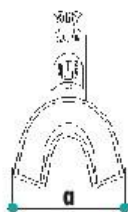

	a		
	+ / - 1,5 mm		
41.4975-211	70 mm	INF 1	
41.4975-212	72 mm	INF 2	
41.4975-213	75 mm	INF 3	
41.4975-214	77 mm	INF 4	
41.4975-215	79 mm	INF 5	

Unterkiefer
Lower jaw
Mandibule
Mandíbula



Oberkiefer
Upper jaw
Maxillaire
Maxilar



41.4970-110 SUP B0
41.4970-111 SUP B1
41.4970-112 SUP B2
41.4970-113 SUP B3
41.4970-114 SUP B4
Bezahnte Kiefer (BO)
Regulars
Maxillaires dentés
Maxillares dentadas



41.4970-131 SUP U1
41.4970-132 SUP U2
41.4970-133 SUP U3
Unbezahnte Kiefer (UO)
Edentulos
Maxillaires édentés
Maxilares desdentados

41



41.4970-121 SUP P1
41.4970-122 SUP P2
41.4970-123 SUP P3
Partiell bezahnte Kiefer (PO)
Partials, depressed centers
Maxillaires partiellement édentés
Maxilares parcialmente desdentados



41.4970-141 SUP F1
41.4970-142 SUP F2
41.4970-143 SUP F3
Funktionsabdrücke (FO)
Functional impressions
Empreintes fonctionelles
Impresiones funcionales

Unterkiefer
Lower jaw
Mandibule
Mandíbula



41.4970-210 INF B0

41.4970-211 INF B1

41.4970-212 INF B2

41.4970-213 INF B3

41.4970-214 INF B4

Bezahnte Kiefer (BU)

Regulars

Maxillaires dentés

Maxillares dentadas

41



41.4970-221 INF P1

41.4970-222 INF P2

41.4970-223 INF P3

Partiell bezahnte Kiefer (PU)

Partials, depressed centers

Maxillaires partiellement édentés

Maxilares parcialmente desdentados



41.4970-231 INF U1

41.4970-232 INF U2

41.4970-233 INF U3

Unbezahnte Kiefer (UU)

Edentulos

Maxillaires édentés

Maxilares desdentados

Oberkiefer
Upper jaw
Maxillaire
Maxilar



41.4972-110 SUP B0
41.4972-111 SUP B1
41.4972-112 SUP B2
41.4972-113 SUP B3
41.4972-114 SUP B4

Bezahnte Kiefer (BO)
Regulars
Maxillaires dentés
Maxilares dentadas



41.4972-131 SUP U1
41.4972-132 SUP U2
41.4972-133 SUP U3

Unbezahnte Kiefer (UO)
Edentulos
Maxillaires édentés
Maxilares desdentados

41



41.4972-121 SUP P1
41.4972-122 SUP P2
41.4972-123 SUP P3

Partiell bezahnte Kiefer (PO)
Partials, depressed centers
Maxillaires partiellement édentés
Maxilares parcialmente desdentados



41.4972-141 SUP F1
41.4972-142 SUP F2
41.4972-143 SUP F3

Funktionsabdrücke (FO)
Functional impressions
Empreintes fonctionelles
Impresiones funcionales

Unterkiefer
Lower jaw
Mandibule
Mandíbula



41.4972-210 INF B0

41.4972-211 INF B1

41.4972-212 INF B2

41.4972-213 INF B3

41.4972-214 INF B4

Bezahnte Kiefer (BU)

Regulars

Maxillaires dentés

Maxillares dentadas

41



41.4972-221 INF P1

41.4972-222 INF P2

41.4972-223 INF P3

Partiell bezahnte Kiefer (PU)

Partials, depressed centers

Maxillaires partiellement édentés

Maxilares parcialmente desdentados



41.4972-231 INF U1

41.4972-232 INF U2

41.4972-233 INF U3

Unbezahnte Kiefer (UU)

Edentulos

Maxillaires édentés

Maxilares desdentados



41

- ▶ Abdrucklöffel für schmale Unterkiefer
- ▶ Impression trays for narrow lower jaws
- ▶ Porte-empreintes pour mandibules étroites
- ▶ Cubetas de impresión para mandíbulas estrechas

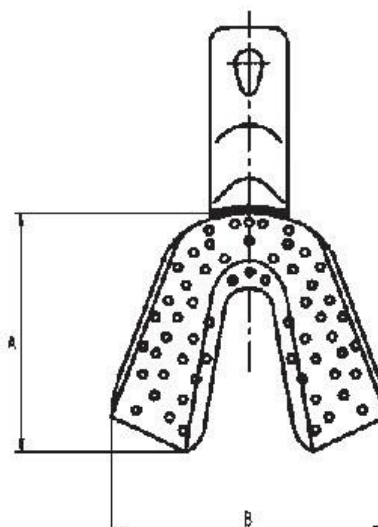

41.4972-251 INF E1

A = 69 mm

B = 55 mm

41.4972-252 INF E2

A = 74 mm

B = 61 mm

41.4972-253 INF E3

A = 78 mm

B = 67 mm



41.4976-2 FIG. L2
A = 50 mm

41.4977-2 FIG. R2
A = 50 mm

41.4976-3 FIG. L3
A = 55 mm

41.4977-3 FIG. R3
A = 55 mm

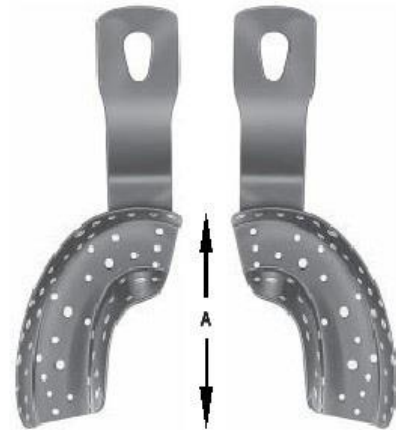

41.4978-1 FIG. L1
A = 46 mm

41.4979-1 FIG. R1
A = 46 mm

41.4978-2 FIG. L2
A = 50 mm

41.4979-2 FIG. R2
A = 50 mm

41.4978-3 FIG. L3
A = 55 mm

41.4979-3 FIG. R3
A = 55 mm

41



41.4980 STOLLEY
mit Schieber
with bolt
avec verrou
con cerrojo



41.4981 STOLLEY
mit Schraube
with srew
avec vis
con tornillo



41.4982 STOLLEY
mit Schieber
with bolt
avec verrou
con cerrojo



41.4983 STOLLEY
mit Schraube
with srew
avec vis
con tornillo



41.4994 REEB
Okklusionslöffel
Occlusal impression tray
Porte-empreinte occlusal
Cubeta oclusale

ABDRUCKLÖFFEL FÜR IMPLANTOLOGIE HELFGEN

- ▶ einfache Handhabung
- ▶ offene und geschlossene Implantatabformung
- ▶ Korrekturabformung möglich
- ▶ Präzisionssteigerung
- ▶ auch bei Sonderindikation universell einsetzbar
- ▶ nur eine Abdrucksitzung notwendig
- ▶ sterilisierbar
- ▶ verschiedene Größen
- ▶ Zeit- und Kostenersparnis



IMPRESSION TRAY FOR IMPLANTOLOGY HELFGEN

41.4990-111 SUP 1
41.4990-112 SUP 2
41.4990-113 SUP 3
41.4990-114 SUP 4

Oberkiefer
 Upper jaw
 Maxillaire
 Maxilar

- ▶ simple handling
- ▶ open and closed implant impression
- ▶ putty-wash impression possible
- ▶ precision enhancement
- ▶ also in special indications universal usable
- ▶ only one impression session required
- ▶ sterilisable
- ▶ different sizes
- ▶ time and cost economized



41.4990-211 INF 1
41.4990-212 INF 2
41.4990-213 INF 3
41.4990-214 INF 4

Unterkiefer
 Lower jaw
 Mandibule
 Mandibula

41.4990-300
 Ausstecher
 Perforator
 Perforateur
 Perforador



- ▶ **Längere Haltbarkeit** durch extraharten Spezialstahl
- ▶ **Exakteres Arbeiten** durch präzise Formgebung
- ▶ **Longer life** through very hard high-grade steel
- ▶ **Better work results** through precise form of pliers
- ▶ **Solidité superieure** par acier inoxydable extra-dur
- ▶ **Travail plus exact** par un précis façonnage des pinces
- ▶ **Solidez superior** por acero inoxidable extra-duro
- ▶ **Trabajo más exacto** por un modelado preciso de las alicates



41.5012

13 cm, gerieft
13 cm, serrated
13 cm, striée
13 cm, estriado



41.5014-1

13 cm, gerieft
13 cm, serrated
13 cm, striée
13 cm, estriado

Flachzangen
Flat nose pliers
Pinces plates
Alicates de picos chatos

41



41.5024

13 cm, gerieft
13 cm, serrated
13 cm, striée
13 cm, estriado



41.5023

13 cm, glatt
13 cm, smooth
13 cm, lisse
13 cm, liso



41.5402 GOSLEE

13 cm, glatt-gerieft, Fig. 136
13 cm, smooth-serrated, Fig. 136
13 cm, lisse-striée, Fig. 136
13 cm, liso-estriado, Fig. 136

Flachzangen
Flat nose pliers
Pincès plates
Alicates de picos chatos



41.5022

12,5 cm, gerieft
12,5 cm, serrated
12,5 cm, striée
12,5 cm, estriado



41.5026

14 cm, gerieft
14 cm, serrated
14 cm, striée
14 cm, estriado



41.5351 FREVERT

12 cm, gerieft
12 cm, serrated
12 cm, striée
12 cm, estriado

41

Drahtbiegeezangen
Wire bending pliers
Pincès à courber les fils
Alicates para doblar alambre

41



41.5153 ADAMS
Fig. 64, 14,5 cm

41.5153F CARBIDE COATING
Mit Hartmetall beschichtet
With extra-hard coating
Avec enduit extra-dur
Con capa extra-dura



41.5155 TC GOLD
mit extra-harten Einsätzen
with extra-hard inserts
avec mors extra-durs
con filos extra-duros



41.5152 ADAMS
12 cm

41.5152F CARBIDE COATING
Mit Hartmetall beschichtet
With extra-hard coating
Avec enduit extra-dur
Con capa extra-dura



41.5154 TC GOLD
mit extra-harten Einsätzen
with extra-hard inserts
avec mors extra-durs
con filos extra-duros



41.5182 ANGLE
12 cm, Bogenbiegezange
12 cm, Arch forming pliers
12 cm, pince à courber les arcs
12 cm, alicata para doblar arcos

Drahtbiegezaugen
Wire bending pliers
Pinces à courber les fils
Alicates para doblar alambre

41

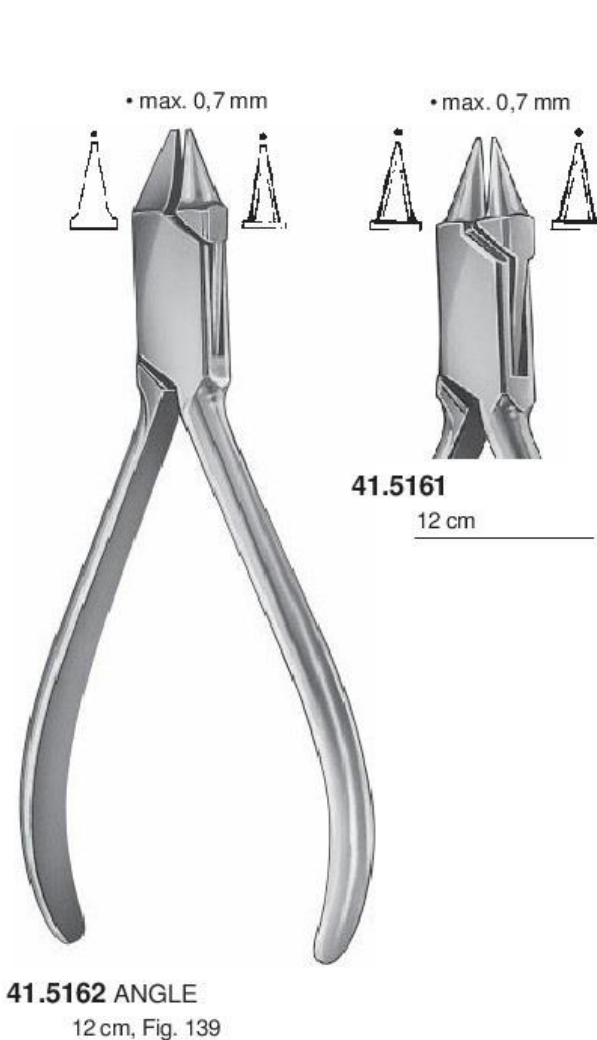

Drahtbiegezaugen
Wire bending pliers
Pincas à courber les fils
Alicates para doblar alambre

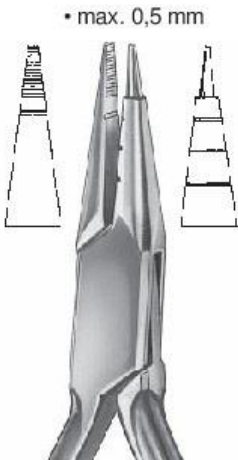

41.5179 JARABAK
13 cm

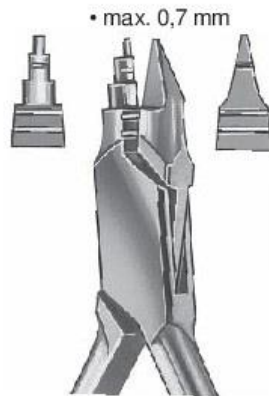

41.5178 YOUNG
14 cm, Fig. 74

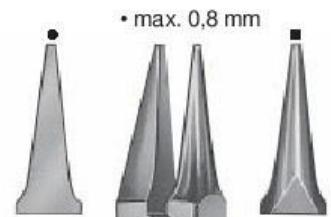

41.5169
16 cm, Fig. 65

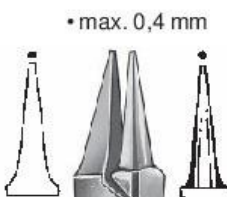

41.5167 LIGHT-WIRE
12 cm

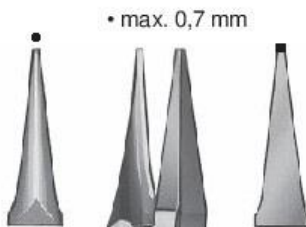

41.5168
14 cm

41.5169-20 TC GOLD
mit extra-harten Einsätzen
with extra-hard inserts
avec mors extra-durs
con filos extra-duros



Drahtbiegezaugen
Wire bending pliers
Pincès à courber les fils
Alicates para doblar alambre



41.5130 ADERER
11,5 cm



41.5132 ADERER
12,5 cm



41.5135 ADERER
12,5 cm

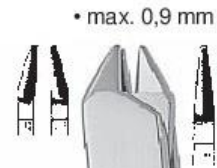

41.5133 ADERER
13 cm, Fig. 200

Drahtbiegeezangen
Wire bending pliers
Pinces à courber les fils
Alicates para doblar alambre

41



41.5113 ADERER
15,5 cm

• max. 3,0 x 1,5 mm

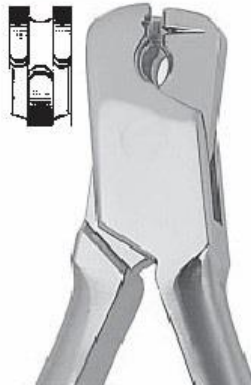

41.5115 ADERER
15 cm

• max. 3,0 x 1,5 mm



41.5105
17 cm, zum Biegen und Schneiden
17 cm, for bending and cutting
17 cm, pour courber et couper
17 cm, para doblar y cortar

• max. 0,7 mm

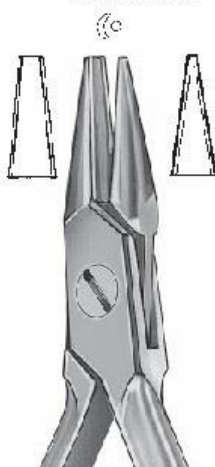

41.5142
13,5 cm

Drahtbiegeezangen
Wire bending pliers
Pincès à courber les fils
Alicates para doblar alambre

41.5125 MC KELLOPS

41.5126 MC KELLOPS

• max. 1,5 mm



41

• max. 0,5 mm



41.5141
13 cm

• max. 0,7 mm



41.5143
13,5 cm

• max. 0,7 mm



41.5144 SCHWARZ
13,5 cm

MC KELLOPS

17 cm, Bùgelbiegeezangen

17 cm, bar bending pliers

17 cm, pincès à plier les barres

17 cm, alicates para doblar barras

Klammerbiegeezangen
Clasp bending pliers
Pincès à courber les crochets
Alicates para doblar ganchos

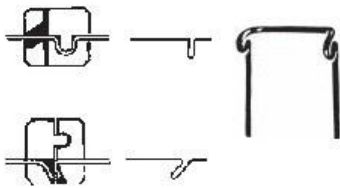

• max. 0,7 mm



41



41.5188

13,5 cm, für Adams-Klammern
13,5 cm, for Adams clasps
13,5 cm, pour crochets de Adams
13,5 cm, para ganchos de Adams



• max. 0,7 mm



41.5190

11,5 cm, Pfeilformzange
11,5 cm, arrow head clasp forming plier
11,5 cm, pince à former les flèches
11,5 cm, alicata para formar les flechas

• max. 0,7 mm



41.5192

11,5 cm, Pfeilknickzange
11,5 cm, arrow head clasp bending plier
11,5 cm, pince à plier les flèches
11,5 cm, alicata para doblar les flechas

• max. 0,7 mm



41.5191

13 cm, kombiniert
13 cm, combined
13 cm, combinées
13 cm, combinado

Universalzangen
Universal pliers
Pinces universelles
Alicates universales

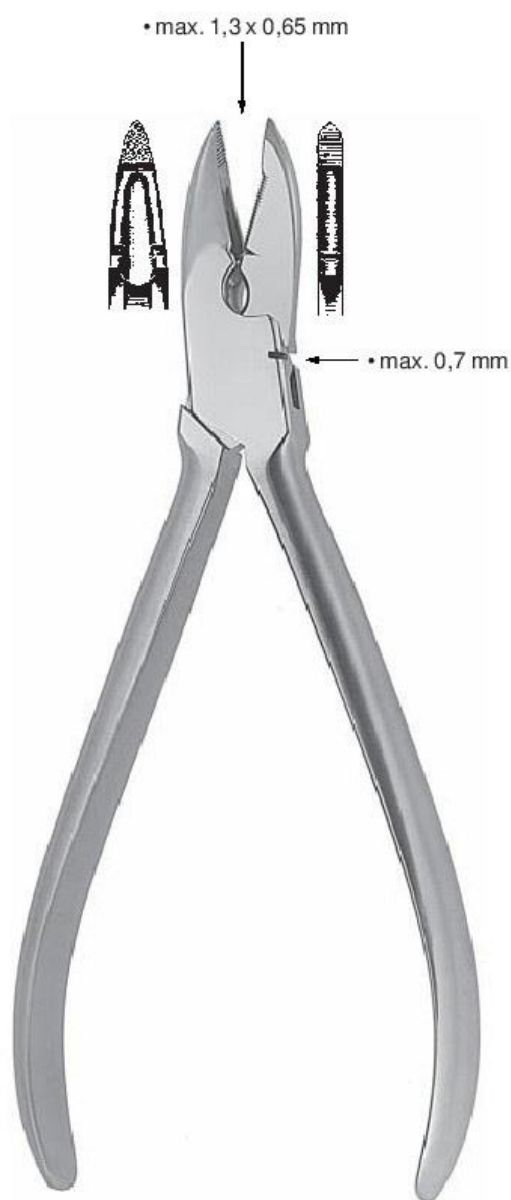

41.5131 WALDSACHS-ORIGINAL
15 cm



41.5600
15 cm

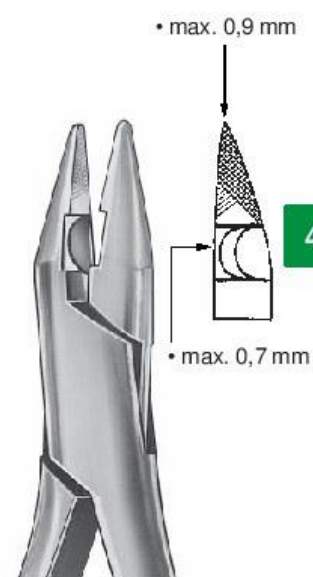

41.5604
mit extra-harten Einsätzen
with extra-hard inserts
avec mors extra-durs
con filos extra-duros

Drahtschneidezangen
Wire cutters
Pincès coupantes
Alicates para cortar alambre

TC GOLD rosttfrei, sterilisierbar, mit extra-harten Einsätzen
stainless, sterilisable, with extra-hard inserts
inoxydable, sterilisable, avec mors extra-durs
inoxidable, esterilizable, con filos extra-duros

41



41.5255

14 cm, verchromt, nicht sterilisierbar
14 cm, chrome-plated, not sterilisable
14 cm, chromée, non-sterilisable
14 cm, cromada, no esterilizable

41.5268

Werkzeugqualität, nicht sterilisierbar
Tool quality, not to be sterilized
Qualité d'outil, non-sterilisable
Caliad de herramienta, no esterilizable

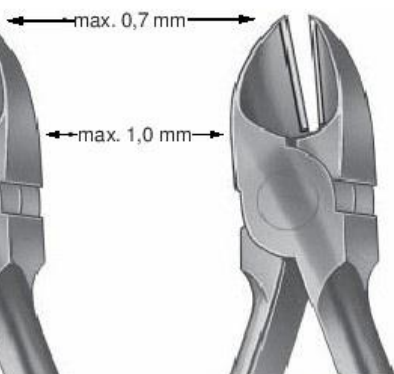

41.5256 TC GOLD

14 cm



• max. 0,5 mm

41.5254 TC GOLD

12 cm



• max. 1,8 mm

41.5260 TC GOLD

18 cm

Drahtspannzange
For wire ligatures
Pour ligatures de fil
Para ligaduras de alambre



41.2024 TC GOLD

15 cm, Hartmetalleinsätze
15 cm, Tungsten carbide inserts
15 cm, Pointes en tungstène
15 cm, Puntas de tungsteno



41.2053

41.2057 TC GOLD

Hartmetalleinsätze
Tungsten carbide inserts
Pointes en tungstène
Puntas de tungsteno

41

MATHIEU

14 cm

Ligaturinstrumente
Ligature instruments
Instruments à ligature
Instrumentos para ligaduras

41



41.5304 HOW
14 cm, Fig. 110



41.5305 HOW
14 cm, Fig. 111



41.5309 WEINGART
13 cm

Bandinstrumente
Band instruments
Instruments à bagues
Instrumentos para bandas



41.4948 OLIVER-JONES
15 cm, Bandabnehmzange
15 cm, band removing pliers
15 cm, pince à enlever les bagues
15 cm, alicata para sacar bandas



41.4950
15 cm, Bandaufsetzer
15 cm, band setter
15 cm, instrument à adapter
15 cm, adaptor de bandas



41.4952 MERSHON
15 cm, Bandandrücker
15 cm, band pushers
15 cm, instrument à pousser
15 cm, empujadores de bandas

Konturzangen
Contouring pliers
Pincès à bouteroller
Alicates para contornear

41



41.5351 FREVERT
12 cm

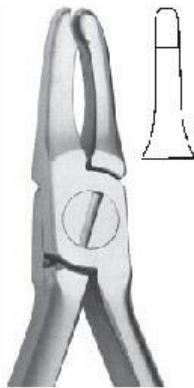

41.5444 JOHNSON
13 cm, Fig. 114



41.5462 GORDON
12,5 cm, Fig. 137



41.5466 REYNOLD
12,5 cm, Fig. 115

A

Abdrucklöffel.....	184-191
Abfallbehälter für Watte.....	92
Abhalter.....	84-85
Abnehmer für Kronen.....	179-182
Abnehmezange für Kupferinge.....	177
Absaugrohre.....	83
Achatspatel.....	158

Adams , Drahtbiegezaugen.....	195
Adams , Klammerbiegezaunge.....	201
Aderer , Drahtbiegezaugen.....	198-199
Adson , anatomische Pinzetten.....	56
Adson , chirurgische Pinzetten.....	58
Ainsworth , Kofferdam-Lochzange.....	160
Allis , Zahnfleischfaßzang.....	61
Amalgampistolen.....	138-139
Amalgamschnitzer.....	152-155
Amalgamstopfer.....	135
Ampullenspritzen.....	93
Anatomic , Abdrucklöffel.....	184-190
Anatomische Pinzetten.....	56-57
Andrücken, Band.....	206
Angle , Bogenbiegezaunge.....	195
Angle , Drahtbiegezaunge.....	196
Apical , Wurzelheber.....	34

Arterienklemmen.....	60
Artikulationspapierpinzette.....	178
Atraumatische Pinzetten.....	57

Aufwachsinstrumente.....	171
--------------------------	-----

B

Backhaus , Tuchklemmen.....	61
Bandinstrumente.....	206
Barry , Wurzelheber.....	40
Baumgartner , Nadelhalter.....	88
Beale , Modellierinstrument.....	170
Beebee , Kronenschere.....	176
Behälte.....	92
Bein , Wurzelheber.....	31
Bennet , Füllungsinstrumenten.....	146
Beyer , Hohlmeißelzange.....	28
Black , Exkavatoren.....	136
Black , Füllungsinstrumente.....	141-145
Black , Gingivalrandschräger.....	130-131
Black , Modellierinstrumente.....	154
Black , Schmelzmeißel.....	130
Blake , Klingenthaler.....	47
Blechscheren.....	176
Blumenthal , Hohlmeißelzange.....	27
Böhler , Hohlmeißelzange.....	28
Böhm , Teleskopkronenzangen.....	183
Bogenbiegezaunge.....	195

Bone spreader.....	77
Bowdler-Henry's Wundhaken.....	83
Bowmann , Knopfsonden.....	80
Boynton , Nadelhalter.....	90

Brenner, Spiritus.....	172
Buchwald , Zungenspatel.....	86
Bügelbiegezaugen.....	199

C

Castroviejo , Nadelhalter.....	87
Castroviejo , Zirkel.....	94
Chirurgische Hämmer.....	74
Chirurgische Kürett.....	69
Chirurgische Nadeln.....	91
Chirurgische Pinzetten.....	58-59
Chirurgische Scheren.....	55
Chompret , Syndesmotome.....	35
Cleoid-Discoid , Modellierinstrumente.....	154
Cogswell , Saugkanüle.....	83
Cohen , Gewebezängchen.....	126
Coleman , Wurzelheber.....	38
College , Zahnpinzetten.....	98-100
Columbia , Universalküretten.....	121
Composite-Instrumente.....	149-151
Contra Winkel-Füllungsinstrumente.....	140-143
Coupland , Wurzelheber.....	33
Crane-Kaplan	59-127
Crane-Kaplan , Zahnreinig.....	112
Crile , Nadelhalter.....	88
Crile-Ryder , Nadelhalte.....	89
Crile-Wood , Nadelhalte.....	89
Zangen für Prothetik und Orthodontie.....	192-207
Cryer , Wurzelheber.....	39
Cryer , Zahnzangen.....	21-23
Cumine , Zahnreiniger.....	111
Cushing , Pinzetten.....	57-59

D

Darby-Perry , Exkavatoren.....	135
Dean , Zahnfleischschere.....	53
DeBakey , atraumatische Pinzetten.....	57
DeBakey , Nadelhalter.....	89
Denhart , Mundsperrer.....	86
Diamantierte Extraktionszangen.....	13-16
Diamantierte Zahnpinzette.....	98-101
Discoid-cleoid , Modellierinstrumente.....	154
Dosen, Nadel.....	91
Doyen, Nadelhalte.....	88
Doyen-Molt , Mundsperrer.....	86
Drahtbiegezaugen.....	192-202
Drahtschneidezangen.....	203
Drahtspannzangen.....	88-90-204-205
Drehmeißel.....	43
Dycal , Füllungsinstrumente.....	143

E

Economy , Mundspiegelgriff.....	96
Ehrlicke , Abdrucklöffel.....	185-188
Elevatoren.....	65-66
Endodontie-Instrumente.....	162-166
Ermert , Wachsmesser.....	172
Epker , Osteotome.....	73
Exkavatoren.....	132-136-162
Extraktionszange.....	5-24
Extraktionszangen, diamantiert.....	13-16

F

Fadenschere.....	50-54
Fadenstopfer, Retraktions.....	177
Fahnenstock , Wachsmesser.....	173
Farabeuf , Wundhaken.....	82
Farbringe für Gracey-Kürett.....	116
Fedi , Parodontal-Meißel.....	71
Feilen, Knochen.....	69
Feilen, Parodontal.....	126
Fingerschützer.....	85
Fissurenzieher.....	151-154-156
Fistelsond.....	80
Flachmeißel.....	70-73
Flachzangen.....	192-194
Flagg , Zahnpinzetten.....	101
Flohr , Wurzelheber.....	34
Folienschere.....	52-176
Fox , Gewebepinzetten.....	59
Fox , Raspatorien.....	67
Frahm , Modellierinstrument.....	155-170
Frazier , Saugkanüle.....	83
Freer , Elevator.....	66
Freer , Flachmeißel.....	71
Freer , Raspatorien.....	66-68
Frevert , Flachzange.....	194-207
Friedman , Hohlmeißelzange.....	25
Füllungsentferner.....	131
Füllungsinstrumente.....	140-151
Füllungsinstrumente für Composite.....	149-151
Füllungsinstrumente für Wurzelkanal.....	163-165
Furchungsküretten.....	120
Furkationssonden.....	106
Furrer , Kupferingabnehmeza.....	177

G

Gefäßklemm.....	60
Geurtsen , Composite-Schaber.....	149
Geurtsen-Günay , Furchungsküretten.....	120
Gewebehaken.....	81
Gewebepinzetten.....	59
Gewebezängche.....	126
Gillet , Exkavator.....	132
Gillies , chirurgische Pinzette.....	58
Gillies , Wundhäkchen.....	81
Gingivalrandschrä.....	130-131

Gingivektomie-Besteck.....	127	Hyllin , Wurzelheber.....	33	Knochenschneidezangen.....	27
Gingivektomie-Instrumente.....	47-125-127	Hyllin-Le Cron , Modellierinstrument... 204		Knopfsonden.....	80
Gingivektomie-Scheren.....	49-53	I		Kocher , Wundhaken.....	83
Gipsmesser.....	174	Ilic , Gewebezügeln.....	126	Kofferdam-Instrumente.....	160-161
Gipsschneidezange.....	174	Implantologie-Abdrucklöffel.....	191	König, Raspatorien.....	65
Gipsspatel.....	175	Injektionsspritzen.....	93	Konturzangen.....	207
Glick , Wurzelkanal-Stopfer.....	165	Instrumente für Aufwachste.....	171	Kopp , Wurzelheber.....	37
Goldmann-Fox	114-122-125-127	Instrumente, Band.....	206	Kornzangen.....	61
Goldmann-Fox, Parodontologie-Set... 127		Instrumente, Composite.....	149-151	Krallenheber.....	41
Goldmann-Fox , Zahnfleissscheren... 49-52		Instrumente, Füllungs.....	140-151	Kramer , chirurgische Küretten.....	69
Gordon , Konturzange.....	207	Instrumente, Gingivektomie.....	125-127	Kramer-Nevins , Parodontal-Meißel.....	71
Goslee , Flachzange.....	193	Instrumente, Keramik.....	169	Kramponzangen.....	202
Gracey Color , Küretten.....	118	Instrumente, Ligatur.....	204-205	Kronenabnehmer.....	179-181
Gracey , Küretten.....	115-117-119-124	Instrumente, Modellier- für Füllungen... 151-155		Kronenabnehmerzangen.....	182
Gracey , Miniatur-Küretten.....	119	Instrumente, Modellier- für Prothetik... 168-171		Kronenscheren.....	176
Griffe, Mundspiegel.....	96	Instrumentenbehälte.....	92-128	Küretten, Alveolar.....	62-64
Griffe für Paro-Instrumente.....	123	Ivory , Amalgampistolen.....	139	Küretten, Furchungs.....	120
Griffe für Skalpellklingen.....	45-47	Ivory , Kofferdam-Klammern.....	161	Küretten, Gracey.....	115-117-119-124
Gritman , Gipsmesser.....	174	Ivory , Kofferdam-Lochzange.....	160	Küretten, Gracey Color.....	118
Gross , Kornzangen.....	61	Ivory , Matrizenspanner.....	137	Küretten, Miniatur.....	119
Guy , Füllungsinstrumente.....	145	Ivory , Separator.....	137	Küretten, Sinus Lift.....	76
Guy , Zahnzange.....	5	Ivory , Stiftzieher.....	162-178	Küretten, Universal.....	121-122-124
H		Iwanson , Zehntelmaß.....	178	Küretten, Wechselgriff.....	123-124
Hämmer, chirurgische.....	74	J		Kupferingabnehmerzange.....	177
Hammer, Plombier.....	139	Jacobson , Nadelhalter.....	88	L	
Hämmer für Techniker.....	172	Jacquette , Zahnreiniger.....	112	Laborzangen.....	192-207
Halsted-Mosquito , Arterienklemmen... 60		Jarabak , Drahtbiegezange.....	197	Ladmore , Füllungsinstrument.....	144
Beyer , Hohlmeißelzange.....	28	Johnson , Konturzange.....	207	La Grange , Zahnfleissschere.....	49-51
Halter für Mini-Klingen.....	45	Jones , Tuchklemme.....	61	Lampe, Spiritus.....	172
Handform Mundspiegelgriffe.....	96	Joseph , Zahnfleissscheren.....	53	Landgraf , Zahnpinzette.....	100
Hartmann , Arterienklemmen.....	60	K		Langenbeck , Fingerschützer.....	85
Hauer , Parodontometer.....	107	Kanalscheren.....	176	Langenbeck , Wundhaken.....	82
Hautzangen.....	126	Kanülen, Saug.....	83	Langer , Universalküretten.....	121
Heat transmitter.....	163	Kelly , Arterienklemmen.....	60	Lecluse , Wurzelheber.....	40
Heber, Wurzel.....	29-42	Kelly , Zahnfleissscheren.....	49-53	Le Cron , Modellierinstrumente.....	169
Heber, Wurzelfragment.....	42	Keramikinstrumente.....	169	Lessmann , Wachsmesser.....	173
Heidbrink , Wurzelheber.....	42	Kilner , Wundhaken.....	81	Lexer-Mini , Osteotom.....	72
Heidemann , Spatel.....	148-150	Kinder-Zahnzangen.....	18-20-23	Lichtenberg-Ryder , Nadelhalter.....	90
Helfgen , Abdrucklöffel für die Implantologie 191		Kirkland , Parodontalmesser.....	125	Lichtenstein , Spatel für Abdruckmassen... 175	
Hemingway , Scharfe Löffel.....	63	Klammern, Kofferdam.....	161	Lift-ex , Kronenabnehmer.....	180
Hilger , Abhalter.....	85	Klammerzange, Kofferdam.....	161	Ligaturscheren.....	50-54
Hirschfeld , Parodontalfeilen.....	126	Klammerbiegezangen.....	195-202	Ligaturzangen.....	204-205
Hirtenstab, Kronenabnehmer.....	179	Klein , Zahnzangen für Kinder.....	20	Light-Wire, Drahtbiegezange.....	197
Hoe , Zahnreiniger.....	114-127	Klemmen.....	60-61	Lindo-Levien , Wurzelheber.....	36
Hohlkehlezangen.....	200	Klingen für Skalpelle.....	45-46	Littauer , Ligaturschere.....	54
Hohlmeißel.....	72	Klingenentferner.....	47	Lochzange, Kofferdam.....	160
Hohlmeißelzangen.....	25-28	Knabberzangen.....	25-28	Locklin , Zahnfleissschere.....	53
Hollenback , Füllungsinstrument.....	145	Knochenenerweiterungssystem.....	77	Löffel, Abdruck.....	184-191
Hollenback , Modellierinstrumente... 152-168		Knochenfeilen.....	69	Löffel, Scharfe.....	62-64
Holst , Zahnsonde.....	102	Knochenhaltepinzette.....	59	Lötspinzette.....	172
Hopson , Füllungsinstrumente.....	145			London-College , Zahnpinzetten... 98-100	
Hornhammer.....	172			London-Hospital , Wurzelheber.....	38
How , Ligaturzangen.....	205			Lucas , Flach- und Hohlmeißel.....	72
Hygienist , Zahnreiniger.....	110-111-123			Lucas , Scharfe Löffel.....	64
Hyllin , Modellierinstrument.....	169			Luer , Hohlmeißelzange.....	26

Luer-Friedmann , Hohlmeißelzang.....	26
Luks , Wurzelkanal-Stopfer.....	164
Luniatschek , Tamponstopfer.....	80
Luxator , Wurzelheber.....	29-30

M

Markierungspinzetten.....	59-127
Markierungsringe für Gracey-Küretten.....	116
Martini , Scharfer Löffel.....	62
Mathieu , Nadelhalter.....	90
Mathieu-Eiselsberg , Nadelhalter.....	90
Matrizenspanner und Matrizen.....	137
Maty , Vestibulum-Haken.....	84
Mayo-Hegar , Nadelhalter.....	89
McCall , Universalküretten.....	122-124
McCall , Zahnreiniger.....	113
McKellops , Bügelbiegezangen.....	200
Mead , Chirurgischer Hammer.....	74
Medikamententräger.....	80
Medium , Zahnsonden.....	105
Meißel.....	70-73
Meißel, Schmelz.....	130
Meriam , Zahnspinzetten.....	101
Mershon , Bandandrücker.....	206
Messer, Parodontal.....	47-125-127
Messer, Gips.....	174
Messer, Wachs.....	172-173
Meß-Instrumente.....	94-178
Methot , Behälter.....	92
Metzenbaum , Präparierscheren.....	55
Micro , Nadelhalter.....	18-88
Micro , Resektionsspiegel.....	37
Micro , Zahnfleissscheren.....	51
Micro-Adson , Pinzetten.....	56-58
Middeldorpf , Wangenhalter.....	85
Miller , Artikulationspapierpinzette.....	178
Miller-Colburn , Knochenfeilen.....	69
Mini-Friedman , Hohlmeißelzangen.....	25
Mini-Klingen.....	45
Minnesota , Mundwinkelhalter.....	79
Mitchell , Modellierinstrument.....	170
Mitchell , Osteotrimmer.....	111
Modellierinstrumente für Füllungen.....	151-155
Modellierinstrumente für Prothetik.....	168-171
Molt , Mundsperrer.....	86
Molt , Raspatorien.....	67
Morell , Kronenabnehmer.....	179
Morse , Zahnreiniger.....	113
Mortonson , Füllungsinstrument.....	145
Mosquito , Klemmen.....	60
Müller-Senn , Wundhaken.....	81
Mundsperrer.....	86
Mundspiegel.....	97
Mundspiegelgriffe.....	96
Mundwinkelhalter.....	85

N

Nabers , Parodontal-Sonde.....	106
Nadeldose.....	91
Nadelhalter.....	87-90
Nähnadel.....	91
Nahtpinzette.....	57-91
Nierenschalen.....	92
Niethammer.....	172
Northbent , Ligaturschere.....	54
Noyes , Zahnfleissscheren.....	53
Nyström , Matrizenspanner.....	137
Nyström , Modellierinstrumente.....	153-168

O

Obwegeser , Raspatorien.....	65
Ochsenbein, Parodontal-Meißel.....	70
Okklusionslöffel.....	190
Oliver-Jones , Bandabnehmerzange.....	208
Optiflex , Zahnsonden.....	104-105
Orban , Parodontalmesser.....	125
Oringer , Lippen-sperrer und Wangenhalter.....	86
Osteotome.....	72-73
Orthodontische Zangen.....	192-207
Osteotrimmer.....	111

P

Parallelklingen-Skalpellgriffe.....	47
Parmly , Zahnzange.....	21
Parodontal-Besteck.....	127
Parodontalfeile.....	126
Parodontal-Meißel.....	70-71
Parodontalmesser.....	47-125-127
Parodontal-Sonden.....	106-107
Parodontomete.....	107
Partsch , Flachmeißel.....	72
Partsch , Raspatorien.....	66
Perigrip , Abdrucklöffel.....	184
Periotome.....	75
Perry , Zahnspinzetten.....	100
Pfeilform- und Pfeilknickzangen.....	201
Pinzetten, anatomische.....	56-57
Pinzette, Artikulationspapier.....	166
Pinzetten, chirurgische.....	58-59
Pinzetten, Gewebe.....	59
Pinzette, Löt.....	172
Pinzette, Naht.....	57-91
Pinzetten für Silberspitzen.....	99-166
Pinzetten, Taschenmarkierungs.....	59-127
Pinzetten, Zahn.....	98-101
P.K Thomas , für Aufwachstechnik.....	171
Planatoren, Füllungsinstrumente.....	143
Plombierhamme.....	139
Polierer.....	151-156-157
Pott , Wurzelheber.....	41

Präparierscheren.....	55
Prichard , Raspatorien.....	68
Protector , Sterilisierrahmen.....	128
Prothetische Zangen.....	192-207
Pulpakanal-Excavatoren.....	132-162

Q

Quick-Change , Wechselgriff und -spitzen.....	123-124
Quinby , Zahnfleissschere.....	52

R

Rahmen, Kofferdam.....	160
Rahmen, Sterilisier.....	128
Ramushaken.....	83
Rasierklingenhalter.....	45
Raspatorien.....	65-68
Read , Zahnzange.....	7
Reeb , Okklusionslöffel.....	190
Reiniger, Zahn.....	110-114-123-124
Resektions-Spiegel.....	97
Retraktionsfadenstopfer.....	177
Reynold , Konturzange.....	207
Rhodes , Parodontal-Meißel.....	70
Rhodium , Mundspiegel.....	97
Riegner , Modellierinstrument.....	170
Rollet , Wundhaken.....	81
Rotondo	140-141-143-147-148
Rotondo , Exkavatoren.....	132
Routurier , Zahnzangen.....	11
Roux , Wangenhalter.....	85
Rundzangen.....	196

S

Saugkanülen.....	83
Schaber, Composite.....	149
Schär Wundhaken und Wangenhalte.....	82
Scharfe Löffel.....	62-64
Scaler.....	110-114-123-127
Scheren, chirurgische.....	55
Scheren, Präparie.....	55
Scheren, Folien.....	51-176
Scheren, Kronen- und Blech.....	176
Scheren, Ligatur.....	50-54
Scheren, Zahnfleisch.....	49-53
Schluger , Parodontalfeile.....	126
Schmerzmeißel.....	130
Schneidezangen, Gips.....	174
Schnitzinstrumente für Füllungen.....	151-155
Schwarz , Drahtbiegezange.....	200
Seitenschneider.....	203
Seldin , Raspatorium.....	67
Seldin , Wurzelheber.....	39
Semken , anatomische Pinzetten.....	56

Semken , chirurgische Pinzetten.....	58	Tönnis , Nadelhalter.....	88	Wurzelzangen.....	8-12-14-16-17
Senn-Green , Wundhaken.....	81	Tofflemire , Matrizenspanner.....	137	Wurzelzangen, diamantiert.....	14-16-17
Senn-Müller , Wundhaken.....	81	Tomes , Zahnzange.....	24	Y	
Separator.....	137	Towner , Zahnreiniger.....	114	Young , Drahtbiegezeuge.....	197
Serviettenhalter.....	96	Trays.....	92-128	Younger-Good , Universalküretten.....	122
Silberspitzeninstrumente.....	149	Treymann , Kronenabnehmer.....	179	Z	
Silberspitzenpinzette.....	99-166	Tuchklemmen.....	61	Zahle , Modellierinstrumente.....	169
Silikonmesser.....	170	U		Zahnpinzetten.....	98-101
Sinus Lift Küretten.....	76	Uffenorde , Scharfe Löffel.....	62	Zahnreiniger.....	110-114-123-127
Sinusboden-Elevatoren.....	78-79	Universal, Kronenabnehmer.....	181	Zahnsonden.....	102-105
Skalpelle, Griffe und Klängen.....	45-47	Universalküretten.....	121-122-124	Zahnfleischfaßzange.....	61
Sonden, Zahn.....	102-105	Universal, Retraktionsfadenstopfer.....	177	Zahnfleisch-Scheren.....	49-53
Sonden, Parodontal.....	106-107	Universal, Zahnsonden.....	102-103	Zahnzangen, amerikanische Form.....	21-24
Sonden, Knopf.....	80	Universal, Zahnzangen.....	21-23-24	Zahnzangen, anatomischer Griff.....	13-16
Sonde, Wurzelkanal.....	105-162	Universal, Zangen für Prothetik und Orthodontie.....	202	Zahnzangen, diamantiert.....	13-16
Spatel für Abdruckmassen.....	175	V		Zahnzangen, englische Form.....	5-20
Spatel für Füllungen.....	141-151	Vestibulumhaken.....	84	Zahnzangen, Kinder.....	18-20-24
Spatel, Zement.....	158-159	Vignon , Modellierinstrument.....	155	Zange für Adams-Klammern.....	201
Spatel, Zungen.....	86	Volkman , Scharfe Löffel.....	62	Zange, Bandabnehme.....	206
Spencer , Ligaturscheren.....	54	W		Zange, Bogenbiege.....	195
Spiegel und -Griffe.....	96-97	WACD , Modellierinstrument.....	154	Zangen, Bügelbiege.....	199
Spina Nasalis -Haken.....	83	Wachsmesser.....	172-173	Zangen, Drahtbiege.....	192-202
Spirituslampe.....	172	Wagner , Zahnfleischschere.....	51	Zangen, Drahtschneide.....	203
Splitterzangen.....	17	Waldsachs-Original , Universalzange.....	202	Zangen, Drahtspann.....	88-90-214-205
Spreizer, Wurzelkanal.....	163	Wangenhalter.....	84-86	Zangen, Flach.....	192-194
Spritzen.....	93	Ward , Füllungsinstrumente.....	146	Zangen, Gewebe.....	126
Sterilisier-Rahmen.....	128	Ward , Modellierinstrumente.....	153-168	Zange, Gipschneide.....	174
Sternberg , Wangenhalter.....	85	Warwick-James , Wurzelheber.....	38	Zangen, Hohlkehl.....	200
Stevens , Zahnfleischschere.....	50	Wasserspritze.....	93	Zangen, Hohlmeißel.....	25-28
Stieglitz , Zange für Wurzelfragmente.....	17	Wattebehälter.....	92	Zangen, Kinder.....	18-20-24
Stiftzieher.....	162-178	Wechselgriff, Küretten.....	123-124	Zangen, Knochenschneide.....	27
Stoke , Kofferdam-Klammerzange.....	161	Weingart , Ligaturzange.....	205	Zangen, Kofferdam.....	160-161
Stolley , Abdrucklöffel.....	190	West , Raspatorien.....	68	Zangen, Klammerbiege.....	195-202
Stopfer.....	140-146-149-151	Westcott , Polierer.....	156	Zangen, Kontur.....	207
Stopfer, Wurzelkanal.....	164-165	Weston , Zahnsonde.....	103	Zangen, Korn.....	61
Stopfer, Retraktionsfaden.....	177	WHO , Parodontal-Sonden.....	106	Zangen, Kronenabnehme.....	182
Stopfer, Tampon.....	80	Wieder , Zungendrücker.....	86	Zange, Kupferingabnehme.....	177
Sugarman , Gewebezüngchen.....	126	Wiland , Modellierinstrument.....	152	Zangen, Ligatur.....	204-205
Super-Cut , Zahnfleischscheren.....	48-53	Williams , Füllungsinstrumente.....	146	Zangen, Pfeilform- und Pfeilknick.....	201
Syndesmotome.....	35	Williams , Parodontal-Sonde.....	106	Zangen für Prothetik und Orthodontie.....	192-207
T		Williger , chirurgische Hämmer.....	74	Zangen, Rund.....	196
Tamponstopfer.....	80	Williger , Elevator.....	65	Zangen, Teleskopkronen.....	183
Tantal , Composite-Instrumente.....	149	Williger , Raspatorien.....	65	Zangen, Wurzel.....	8-12-14-16-17
Taschenmarkierungspinzetten.....	59-127	Williger , Scharfer Löffel.....	62	Zangen, Wurzelfragmente.....	17
Tasterzirkel.....	178	Winter , Wurzelheber.....	40	Zangen, Wurzelstift.....	166
Taylor , Pinzetten.....	57-59	Witzel , Wurzelzangen.....	17	Zangen, Zahn.....	5-24
Taylor , Zahnreiniger.....	112	Woodson , Füllungsinstrumente.....	146	Zange, Zahnfleischfaß.....	61
TC-Pinzetten.....	54	Wundhaken.....	81-83	Zehntelmaß.....	178
TC-Scheren.....	50-52	Wundsonden.....	80	Zementspatel.....	158-169
Technikzangen.....	192-207	Wurzelheber.....	29-42	Zirkel.....	94
Teleskopkronenzangen.....	183	Wurzelkanalinstrumente.....	162-166	Zungensspatel.....	86
Thomas P.K. , für Aufwachstechnik.....	171	Wurzelstiftzange.....	166	Zylinder-Ampullen-Spritzen.....	93
Thorpe , Zahnreiniger.....	110				

A	
Adams, clasp bending pliers.....	201
Adams, wire bending pliers.....	195
Adapters, band.....	206
Aderer, wire bending pliers.....	198-199
Adson, dissecting forceps.....	56
Adson, tissue forceps.....	58
Agate spatulas.....	158
Ainsworth, punch forceps.....	160
Alcohol lamps.....	172
Allis, gum seizing forceps.....	61
Alveolar curettes.....	62-64
Amalgam carriers.....	138-139
Amalgam carvers.....	152-155
Amalgam pluggers.....	140-146
Anatomic, impression trays.....	184-190
Angle, arch forming pliers.....	195
Angle, wire bending pliers.....	196
Apical, root elevators.....	34
Applicators, medicine.....	80
Applicators, tampon.....	80
Arch forming pliers.....	195
Arrow head clasp bending and forming pliers... 201	
Artery forceps.....	60
Articulation paper forceps.....	178
Atraumatic forceps.....	57
B	
Backhaus, towel clips.....	61
Band instruments.....	206
Bar bending pliers.....	200
Barry, root elevators.....	40
Baumgartner, needle holders.....	88
Beale, carvers.....	170
Beebee, crown scissors.....	176
Bein, root elevators.....	31
Bennet, filling instruments.....	146
Beyer, rongeur forceps.....	28
Black, enamel chisels.....	130
Black, excavators.....	136
Black, filling instruments.....	141-145
Black, gingival margin trimmers.....	130-131
Black, carvers.....	154
Blade removers.....	47
Blades for scalpel.....	45-46
Blake, blade holders.....	47
Blumenthal, rongeur forceps.....	27
Bhler, rongeur forceps.....	27
Böhm, pliers for telescope crowns.....	183
Bone chisels and gouges.....	70-73
Bone curettes.....	62-64
Bone cutting forceps.....	27
Bone files.....	69
Bone holding forceps.....	59
Bone spreaders.....	77
Bowdler-Henry, retractor.....	83
Bowls, kidney.....	92
Bowmann, probe.....	80
Boynnton, needle holders.....	90
Brewer, clamp forceps.....	161
Buchwald, tongue depressors.....	86
Burners, alcohol.....	172
Burnishers.....	151-156-157
Burnishers, root.....	126
C	
Calculus removers.....	110-114-123-127
Calibrated probes.....	106-107
Calipers.....	94-178
Cannula, suction.....	83
Carriers, amalgam.....	138-139
Cartridge syringes.....	93
Carvers for amalgam.....	151-155
Carvers for prosthodontia.....	181-184
Cases for instruments.....	92-128
Castroviejo, Calipers.....	94
Castroviejo, needle holders.....	87
Cement spatulas.....	158-159
Cheek retractors.....	84-86
Chisels.....	43-70-73
Chisels, enamel.....	130
Chompret, syndesmotomes.....	35
Clamp forceps.....	161
Clamps for rubber dam.....	161
Clasp bending pliers.....	192-202
Cleaners, tooth.....	110-114-123-127
Clips for towels.....	61
Cogswell, suction tubes.....	83
Cohen, tissue nippers.....	126
Coleman, root elevators.....	38
College, tweezers.....	98-100
Colour rings for curettes.....	116
Columbia, universal curettes.....	121
Composite carvers.....	149-151
Composite instrumente.....	149-151
Contouring pliers.....	207
Contra-angled filling instruments.....	140-143
Copper ring removing pliers.....	177
Cotton holders.....	92
Coupland, root elevators.....	33
Crane-Kaplan, pocket markers.....	59-127
Crane-Kaplan, scalars.....	112
Crile, needle holders.....	88
Crile-Ryder, needle holders.....	89
Crile-Wood, needle holders.....	89
Pliers for prosthodontia and orthodontia.....	92-207
Crown removers.....	179-181
Crown scissors.....	176
Crown trial forceps.....	182
Cryer, extracting forceps.....	21-23
Cryer, root elevators.....	39
Cumine, scalars.....	111
Curettes, bone.....	62-64-69
Curettes, for root depressions.....	120
Curettes, for sinus lift.....	76
Curettes, Gracey.....	115-117-119-124
Curettes, Gracey Color.....	118
Curettes, miniatur.....	119
Curettes, „Quick-change.....	123-124
Curettes, surgical.....	69
Curettes, universal.....	121-122-124
Cushing, dissecting forceps.....	57
Cushing, tissue forceps.....	59
Cutters, wire.....	203
Cutting instruments.....	130
D	
Darby-Perry, excavators.....	135
Dean, gum scissors.....	53
DeBaKey, atraumatic forceps.....	57
DeBaKey, needle holders.....	89
Decimal calipers.....	178
Denhart, mouth gags.....	86
Depressor, tongue.....	86
Diamond coated extracting forceps.....	13-16
Diamond coated tweezers.....	98-101
Discoid-cleoid, carving instruments.....	154
Dispensers.....	92
Dissecting forceps.....	56-57
Dissecting scissors.....	55
Doyen, needle holders.....	88
Doyen-Molt, mouth gags.....	86
Dressing forceps.....	61
Dycal, filling instruments.....	143
E	
Economy, mouth mirror handle.....	96
Ehrlicke, Anatomic impression trays.....	185-188
Eiselsberg-Mathieu, needle holders.....	90
Elevators.....	29-42
Elevators, root fragment.....	42
Elevators, periosteal.....	65-68
Enamel chisels.....	130
Endodontic instruments.....	162-166
Epker, osteotomes.....	73
Ermert, wax knives.....	172
Excavators.....	132-136-162
Explorers.....	102-105
Explorers, root canal.....	105-162
Extracting forceps.....	5-23
Extracting forceps, american pattern.....	21-24
Extracting forceps, anatomic handle.....	13-16
Extracting forceps, diamond coated.....	13-16
Extracting forceps, english pattern.....	5-20
Extracting forceps for children.....	18-20-24

- F**
- Fahnenstock**, wax knife..... 173
- Farabeuf**, retractors..... 82
- Fedi**, periodontal chisels..... 71
- Files, bone..... 69
- Files, periodontal..... 126
- Filling instruments..... 140-151
- Filling instruments, composite..... 149-151
- Filling instruments, root canal..... 163-165
- Finger protectors..... 85
- Fistula probes..... 80
- Flagg**, tweezers..... 101
- Flat nose pliers..... 192-194
- Flohr**, root elevators..... 34
- Foil scissors, ceramics..... 51-176
- Forceps, articulating paper..... 178
- Forceps, children..... 18-20-24
- Forceps haemostatic..... 60
- Forceps, clamp..... 161
- Forceps, crown trial..... 182
- Forceps, dissecting..... 56-57
- Forceps, dressing..... 61
- Forceps, extracting..... 5-24
- Forceps, gum seizing..... 61
- Forceps, punch..... 160
- Forceps, rongeur..... 25-28
- Forceps, root..... 8-12-14-16-17
- Forceps, root fragment..... 17
- Forceps, root pin..... 166
- Forceps, silver points..... 99-166
- Forceps, suture..... 57-91
- Forceps, tissue..... 58-59
- Fox**, gum seizing forceps..... 59
- Fox**, periosteal elevators..... 67
- Fragment ejectors..... 42
- Fragment forceps..... 17
- Frahm, carvers..... 155-170
- Frames, rubber dam..... 160
- Frazier**, suction tubes..... 83
- Freer**, chisels..... 71
- Freer**, periosteal elevators..... 66-68
- Frevert**, flat nose pliers..... 194-207
- Friedman**, rongeur forceps..... 25
- Furcation probes..... 106
- Furrer**, copper ring removing pliers..... 177
- G**
- Gags, mouth..... 86
- Geurtsen**, composite carvers..... 149
- Geurtsen-Günay**, curettes for root depressions..... 120
- Gillet**, excavators..... 132
- Gillies**, retractors..... 81
- Gillies, tissue forceps..... 58
- Gingival cord packers..... 177
- Gingival margin trimmers..... 130-131
- Gingivectomy instruments..... 47-125-127
- Gingivectomy set..... 127
- Glick**, root canal pluggers..... 165
- Goldmann-Fox**, gingivectomy set..... 127
- Goldmann-Fox**, gum scissors..... 49-52
- Goldmann-Fox**,..... 114-122-125-127
- Gordon**, contouring pliers..... 207
- Goslee**, flat nose pliers..... 193
- Gouges..... 72
- Gracey**, curettes..... 115-117-119-124
- Gracey**, curettes miniatur..... 119
- Gracey Color**, curettes..... 118
- Gritman**, plaster knives..... 174
- Gross**, dressing forceps..... 61
- Gum nippers..... 126
- Gum scissors..... 49-53
- Gum seizing forceps..... 61
- Guy**, extracting forceps..... 5
- Guy**, filling instruments..... 145
- H**
- Haemostatic forceps..... 60
- Halsted-Mosquito**, haemostatic forceps..... 60
- Hammers..... 74-139-172
- Handles, mouth mirror..... 96
- Handles, perio instruments..... 123
- Handles, scalpels..... 45-47
- Harris**, extracting forceps..... 22
- Hartmann Baby-Mosquito**,..... 60
- Hauer**, calibrated probe..... 107
- Heat transmitter..... 163
- Heidbrink**, root elevators..... 42
- Heidemann**, spatulas..... 148-150
- Helfgen**, impression trays for implantology..... 191
- Hemingway**, bone curettes..... 63
- Hilger**, retractor..... 85
- Hirschfeld, files..... 126
- Hoe**, scalars..... 114-127
- Holder for mini scalpel blades..... 45
- Holder, needle..... 87-90
- Holder, razor blade..... 45
- Hollenback, carvers..... 152-168
- Hollenback**, filling instruments..... 145
- Holst**, explorer..... 102
- Hopson**, filling instruments..... 145
- Horn mallets..... 172
- How, ligature pliers..... 205
- Hygienist**, scalars..... 110-111-123
- Hylin**, carving instruments..... 169
- Hylin**, root elevators..... 33
- Hylin-Le Cron**, carving instruments..... 169
- I**
- Ilic**, tissue nippers..... 126
- Impression trays..... 184
- Impression trays for implantology..... 191
- Impression trays, occlusal..... 190
- Instrument trays..... 92-128
- Instruments, band..... 206
- Instruments, carving..... 151-155
- Instruments, carving for prosthodontia..... 168-171
- Instruments, ceramics..... 169
- Instruments, composite..... 149-151
- Instruments, filling..... 140-151
- Instruments, gingivectomy..... 47-125-127
- Instruments, ligature..... 204-205
- Instruments, waxing-on technique..... 171
- Ivory**, Amalgam carriers..... 139
- Ivory**, matrix retainers..... 137
- Ivory**, post pullers..... 162-178
- Ivory**, punch forceps..... 160
- Ivory**, rubber dam clamps..... 161
- Ivory**, separators..... 137
- Iwanson**, decimal calibers..... 178
- J**
- Jacobson**, needle holders..... 88
- Jacquette**, scalars..... 112
- Jarabak**, wire bending pliers..... 197
- Johnson**, contouring pliers..... 207
- Jones**, towel clips..... 61
- Joseph**, gum scissors..... 53
- K**
- Kelly**, gum scissors..... 49-53
- Kelly**, haemostatic forceps..... 60
- Kidney bowls..... 92
- Kilner**, retractors..... 81
- Kirkland**, gingivectomy knives..... 125
- Klein**, extracting forceps for children..... 20
- Knives, gingivectomy..... 47-125-127
- Knives, plaster..... 174
- Knives, wax..... 172-173
- Kocher**, retractors..... 83
- König**, periosteal elevators..... 65
- Kopp**, root elevators..... 37
- Kramer**, surgical curettes..... 69
- Kramer-Nevins**, periodontal chisels..... 71
- L**
- La Grange**, gum scissors..... 49-51
- Laboratory pliers..... 192-207
- Ladmore**, filling instruments..... 144
- Lamp, alcohol..... 172
- Landgraf**, tweezers..... 100
- Langenbeck**, finger protectors..... 85
- Langenbeck**, retractors..... 82
- Langer**, universal curettes..... 121
- Le Cron**, carvers..... 169

Lecluse , root elevators.....	40	Mini-Friedman , rongeur forceps.....	25	Periotomes.....	75
Lessmann , wax knives.....	173	Minnesota , cheek and lip retractors.....	85	Perry , tweezers.....	100
Lexer-Mini , osteotome.....	72	Mirrors and handles.....	96-97	Planator , filling instruments.....	143
Lichtenberg-Ryder , needle holders.....	90	Mitchell , carving instruments.....	170	Plaster cutting pliers.....	174
Lichtenstein , spatulas for impression materials.....	175	Mitchell , osteotrimmer.....	111	Plaster knives.....	174
Lift-ex , crown removers.....	180	Modelling instruments.....	151-155	Plate scissors.....	176
Ligature instruments.....	204-205	Modelling instruments for prosthodontia.....	168-171	Pliers, Adams clasp.....	201
Ligature scissors.....	50-54	Molt , mouth gags.....	86	Pliers, arch forming.....	195
Light-Wire, wire bending plier.....	197	Molt , periosteal elevators.....	67	Pliers, arrow head clasp bending and forming.....	201
Lindo-Levien, root elevators.....	36	Morell , crown removers.....	179	Pliers, band removing.....	206
Lip retractors.....	84-86	Morse , scalars.....	113	Pliers, bar bending.....	199
Littauer , ligature scissors.....	54	Mortonson , filling instruments.....	145	Pliers, clasp bending.....	195-202
Locklin , gum scissors.....	53	Mosquito , haemostatic forceps.....	60	Pliers, contouring.....	207
London-College , tweezers.....	98-100	Mouth gags.....	86	Pliers, copper ring removing.....	177
London-Hospital , root elevators.....	38	Mouth mirrors.....	97	Pliers, flat nose.....	192-194
Lucas , bone curettes.....	64	Müller-Senn , retractors.....	81	Pliers, ligature.....	204-205
Lucas , chisels and gouges.....	72	N		Pliers, plaster cutting.....	174
Luer , rongeur forceps.....	26	Nabers , periodontal probe.....	106	Pliers, prosthodontic and orthodontic.....	192-207
Luer-Friedmann , rongeur forceps.....	26	Napkin holder.....	96	Pliers, round nose.....	196
Luks , root canal pluggers.....	164	Needle case.....	91	Pliers, telescope crown.....	183
Luniatshchek , tampon applicators.....	80	Needle holders.....	87-90	Pliers, wire bending.....	192-202
Luxator , root elevators.....	29-30	Needles, suture.....	91	Pliers, wire ligature.....	204-205
M		Nippers, wire.....	203	Pluggers.....	140-146-149-151
Mallets, horn.....	172	Northbent , ligature scissors.....	54	Pluggers, root canal.....	164-165
Mallets, plugging.....	139	Noyes , gum scissors.....	51	Plugging mallets.....	139
Mallets, riveting.....	172	Nyström , matrix retainers.....	137	Pocket markers.....	59-127
Mallets, surgical.....	74	Nyström , carvers.....	153-168	Post pullers.....	162-178
Markers for pockets.....	59-127	O		Pott , root elevators.....	41
Martini , bone curettes.....	62	Obwegeser , periosteal elevators.....	65	Prichard , periosteal elevators.....	68
Mathieu , needle holders.....	90	Occlusal impression trays.....	190	Probes, fistula.....	80
Mathieu-Eiselsberg , needle holders.....	90	Ochsenbein , periodontal chisels.....	70	Probes, periodontal.....	106-107
Matrix retainers and matrixes.....	137	Oliver-Jones , band removing pliers.....	206	Protector, finger.....	85
Maty , vestibulum retractor.....	84	Optiflex , explorers.....	104-105	Protector , instrument trays.....	128
Mayo-Hegar , needle holders.....	89	Orban , gingivectomy knives.....	125	Punch forceps.....	160
McCall , scalars.....	113	Oringer , cheek and lip retractor.....	86	Q	
McCall , universal curettes.....	122-124	Osteotomes.....	72-73	Quick-Change , periodontal instruments.....	123-124
McKellops , bar bending pliers.....	200	Osteotrimmer, Scaler.....	111	Quinby , gum scissors.....	52
Mead , surgical mallets.....	74	P		R	
Measuring probes, pocket.....	106-107	P.K. Thomas , for waxing-on technique.....	171	Ramus retractors.....	83
Medicine applicator.....	80	Packers, gingival cord.....	177	Raspatories.....	65-68
Medium , explorers.....	105	Parallel blade scalpel handle.....	47	Razor blade holders.....	45
Meriam , tweezers.....	101	Parmly , extracting forceps.....	21	Read , extracting forceps.....	7
Mershon , band pushers.....	206	Partsch , chisels and gouges.....	72	Receivers, waste.....	92
Methot , cotton holders.....	92	Partsch , periosteal elevators.....	66	Reeb , occlusal impression trays.....	190
Methot , waste receivers.....	92	Perforators, rubberdam.....	160	Removers, blades.....	47
Metzenbaum , dissecting scissors.....	55	Perigrip , Anatomic impression trays.....	184	Removers, crowns.....	179-181
Micro , gum scissors.....	51	Periodontal chisels.....	70-71	Retainers, matrix.....	137
Micro, mirrors.....	97	Periodontal files.....	126	Retractors.....	81-83
Micro , needle holders.....	87-88	Periodontal knives.....	47-125-127	Reynold , contouring pliers.....	207
Micro-Adson , dissecting forceps.....	56	Periodontal probes.....	106-107	Rhodes , periodontal chisel.....	83
Micro-Adson , tissue forceps.....	58	Periosteal elevators.....	65-68	Rhodium , mouth mirrors.....	97
Middeldorpf , cheek retractors.....	85			Riegner , carving instruments.....	170
Miller , articulating paper forceps.....	178			Riveting mallets.....	172
Miller-Colburn , bone files.....	69			Rollet, retractors.....	81
Mini scalpel blades.....	45				

Romerowski , burnishers.....	157
Rongeur forceps.....	25-28
Root burnishers.....	126
Root canal instruments.....	162-166
Root elevators.....	29-42
Root extracting forceps.....	8-12-14-16-17
Root extracting forceps, diamond coated	4-16-17
Rotondo , excavators.....	132
Rotondo , filling instruments.....	140-141-143-147-148
Round nose pliers.....	196
Routurier , extracting forceps.....	11
Roux , cheek and lip retractors.....	85
Rubber dam instruments.....	160-161

S

Scalers.....	110-11-123-127
Scalpel blades and handles.....	45-47
Schäfer , combined wound and cheek retractor	82
Schluger , periodontal file.....	126
Schwarz , wire bending pliers.....	200
Scissors, crown and plate.....	176
Scissors, foil.....	51-176
Scissors, gum.....	49-53
Scissors, ligature.....	52-54
Scissors, surgical.....	55
Seldin , periosteal elevator.....	67
Seldin , root elevators.....	39
Semken , dissecting forceps.....	56
Semken , tissue forceps.....	58
Senn-Green , retractors.....	81
Senn-Müller , retractors.....	81
Separator.....	137
Sharp spoons.....	62-64

Silicon knife.....	170
Silver points instruments.....	149
Silver points forceps.....	99-166
Sinus lift curettes.....	76
Sinus lift elevators.....	78-79

Soldering tweezers.....	172
Spatulas, cement.....	158-159
Spatulas, filling material.....	141-151
Spatulas, impression material.....	175
Spatulas, plaster.....	175
Spatulas, tongue.....	86
Spencer , ligature scissors.....	54
Spina Nasalis , retractors.....	83
Spreaders, root canal.....	163
Spoons, sharp.....	62-64
Sternberg , cheek and lip retractors.....	85
Stevens , gum scissors.....	50
Stieglitz , root fragment forceps.....	17
Stoke , clamp forceps.....	161
Stolley , impression trays.....	190

Suction tubes.....	83
Sugarman , tissue nippers.....	126
Super-Cut , gum scissors.....	48-53
Surgical curettes.....	69
Surgical mallets.....	74
Surgical scissors.....	55
Suture forceps.....	57-93
Suture needles.....	93
Suture scissors.....	50-54
Syndesmotomes.....	35
Syringes.....	93

T

Tampon applicators.....	80
Tantal , composite instruments.....	149
Taylor , dissecting forceps.....	57
Taylor , scalars.....	112
Taylor , tissue forceps.....	59
TC dissecting forceps.....	56
TC scissors.....	50-52
Telescope crown pliers.....	183
Thomas P.K. for waxing-on technique.....	171
Thorpe , scalars.....	110
Tissue forceps.....	58-59
Tissue nippers.....	126
Toffemire , matrix retainers.....	137

Tomes , extracting forceps.....	24
Tongue depressors.....	86
Tönnis , needle holders.....	88

Towel clips.....	61
Towner , scalars.....	114
Trays for instruments.....	92-128
Treymann , crown removers.....	179
Tubes, suction.....	83
Tweezers.....	98-101
Tweezers, diamond coated.....	98-101
Tweezers, soldering.....	172

U

Uffnorde , bone curettes.....	62
Universal crown removers.....	181
Universal curettes.....	121-122-124
Universal explorers.....	102-103
Universal extracting forceps.....	21-23-24
Universal gingival cord packer.....	177
Universal pliers for prosthodontia and orthodontia.....	202

V

Vestibulum retractors.....	84
Vignon , carvers.....	155
Volkman , bone curettes.....	62

W

WACD , carvers.....	154
Wagner , gum scissors.....	51
Waldsachs-Original , universal pliers.....	202
Ward , carvers.....	153-168
Ward, filling instruments.....	146
Warwick-James , root elevators.....	38
Waste receiver.....	92
Water syringe.....	93
Wax knives.....	172-173
Waxing-on technique.....	171
Weingart , ligature pliers.....	205
West , periosteal elevators.....	68
Westcott , burnishers.....	156
Weston , explorer.....	103
WHO , periodontal-probe.....	106
Wieder , tongue depressors.....	86
Wiland , carvers.....	152
Williams , filling instruments.....	146
Williams , periodontal probe.....	106
Williger , bone curettes.....	62
Williger , mallets.....	74
Williger , periosteal elevators.....	65
Winter , root elevators.....	40
Wire bending pliers.....	192-202
Wire cutters.....	203
Witzel , forceps for roots.....	17
Woodson , filling instruments.....	146

Y

Young , wire bending pliers.....	197
Younger-Good , universal curettes.....	122

Z

Zahle , carving instruments.....	169
---	-----